

# FontanaArte

MILANO 1932

LISTINO / PRICE LIST 2024



FontanaArte nasce a Milano nel 1932 dall'incontro di Gio Ponti, grande padre dell'architettura italiana del Novecento, con Luigi Fontana, imprenditore del vetro in lastra, e Pietro Chiesa, maestro nell'arte vetraria. FontanaArte accompagna l'esplorazione della modernità italiana per cui vetro e metallo sono l'espressione di una nuova idea di bellezza profusa di luce e trasparenze. La sua storia è segnata dalla produzione di lampade e ogni tipo di soluzione che porta la luce nello spazio abitato, una missione senza tempo che si tramanda tra icone e nuovi prodotti.

FontanaArte was founded in Milan in 1932, originating in an encounter between Gio Ponti (the great 20th-century maestro of Italian architecture), Luigi Fontana (entrepreneur of sheet glass) and Pietro Chiesa (a master glass artisan). FontanaArte accompanied Italy's exploration of modernity, where glass and metal expressed a new idea of beauty infused with light and transparency. The history of FontanaArte is distinguished by lamps and every type of object that brought light into the inhabited space. This timeless mission has been passed down from icon to new product.

# INDEX



# LAMPADE DA TAVOLO / TABLE LAMPS

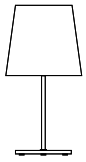

**3247TA**  
Historical Archive  
p. 13



**ASHANGHAI**  
Max Ingrand  
p. 15

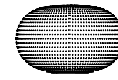

**BIANCA**  
Matti Klenell  
p. 17

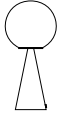

**BILIA MINI**  
Gio Ponti  
p. 19

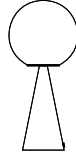

**BILIA**  
Gio Ponti  
p. 20

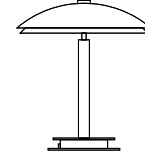

**BIS / TRIS**  
Historical Archive  
p. 22



**BLOM**  
Andreas Engesvik  
p. 25



**BLOM X PARLEY**  
Andreas Engesvik  
p. 27



**CAMEO**  
Claesson Koivisto Rune  
p. 29

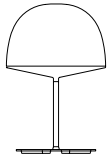

**CHESHIRE**  
GamFratesi  
p. 31



**DARUMA**  
Sergio Asti  
p. 33

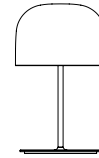

**EQUATORE**  
Gabriele e Oscar Buratti  
p. 36

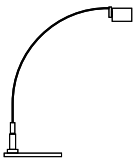

**FALENA**  
Alvaro Siza  
p. 39

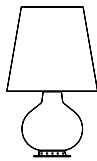

**FONTANA**  
Max Ingrand  
p. 41

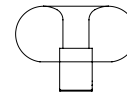

**FONTANELLA**  
Federico Peri  
p. 44

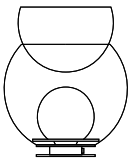

**GIOVA**  
Gae Aulenti  
p. 46



**LOOP**  
Voon Wong & Benson Saw  
p. 49

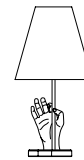

**MANO**  
Pietro Chiesa  
p. 51

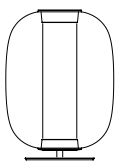

**MERIDIANO**  
Gabriele e Oscar Buratti  
p. 54

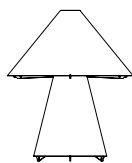

**METAFORA**  
Umberto Riva  
p. 56

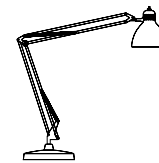

**NASKA**  
Historical Archive  
p. 59



**PALLINA**  
FontanaArte Design Lab  
p. 63

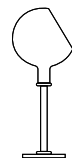

**PAROLA**  
Gae Aulenti e Piero Castiglioni  
p. 65

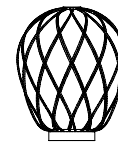

**PINECONE**  
Paola Navone  
p. 68

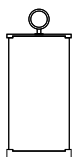

**PIRELLINA**  
Gio Ponti  
p. 71

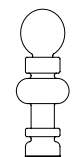

**RE**  
Bobo Piccoli  
p. 73

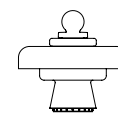

**REGINA**  
Bobo Piccoli  
p. 74

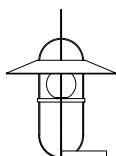

**SETAREH**  
Francesco Librizzi  
p. 77



**THOR**  
Pagani Perversi Architects  
p. 79

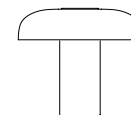

**TROPICO**  
Gabriele e Oscar Buratti  
p. 81

# LAMPADE DA TAVOLO / TABLE LAMPS

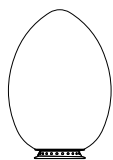

**UOVO**  
Ben Swildens  
p. 84



**UOVO PORTABLE**  
Ben Swildens  
p. 87

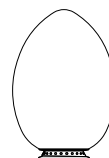

**UOVO OUTDOOR**  
Ben Swildens  
p. 88

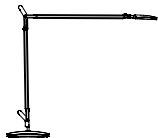

**VOLÉE**  
Odo Fioravanti  
p. 89

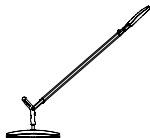

**DEMI VOLÉE**  
Odo Fioravanti  
p. 89

# LAMPADE DA TERRA / FLOOR LAMPS



**3247**  
Historical Archive  
p. 93



**BIANCA**  
Matti Klenell  
p. 95



**CHESHIRE**  
GamFratesi  
p. 97



**EQUATORE**  
Gabriele e Oscar Buratti  
p. 99



**FLÛTE**  
Franco Raggi  
p. 101

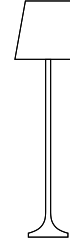

**LUMEN**  
Historical Archive  
p. 104

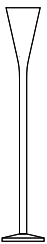

**LUMINATOR**  
Pietro Chiesa  
p. 106



**MERIDIANO**  
Gabriele e Oscar Buratti  
p. 109



**OORT**  
Jacopo Roda  
p. 111



**PAROLA**  
Gae Aulenti e Piero Castiglioni  
p. 113



**PAROLONA**  
Gae Aulenti e Piero Castiglioni  
p. 114

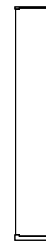

**PIRELLONE**  
Gio Ponti  
p. 116



**PRIMA SIGNORA**  
Daniela Puppa  
p. 118



**VERTIGO**  
Marco Acerbis  
p. 120

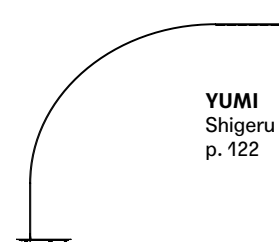

**YUMI**  
Shigeru Ban  
p. 122

# LAMPADE A PARETE / WALL LAMPS

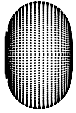

**BIANCA**  
Matti Klenell  
p. 126



**BONNET**  
Odo Fioravanti  
p. 128



**BRUCO**  
Vico Magistretti  
p. 130

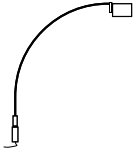

**FALENA**  
Alvaro Siza  
p. 132



**FLEX**  
Karim Rashid  
p. 134

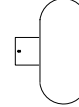

**FONTANELLA**  
Federico Peri  
p. 137



**FRENESI**  
Studiolucaguadagnino  
p. 139



**IO**  
Claesson Koivisto Rune  
p. 142

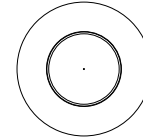

**LUNAIRE**  
Ferréol Babin  
p. 145

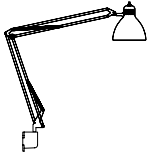

**NASKA**  
Historical Archive  
p. 148

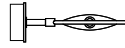

**NOBI**  
Metis Lighting  
p. 151



**PALLINA**  
FontanaArte Design Lab  
p. 153



**PAROLA**  
Gae Aulenti e Piero Castiglioni  
p. 155

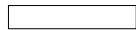

**RIGA**  
Paolo Zani  
p. 157

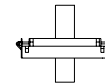

**SCINTILLA**  
Livio e Piero Castiglioni  
p. 159



**SILLABA**  
Piero Castiglioni  
p. 161



**SOLE**  
Bernardino Amato  
p. 163



**TROPICO**  
Gabriele e Oscar Buratti  
p. 165

## LAMPADE A PLAFONE / CEILING LAMPS

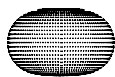

**BIANCA**  
Matti Klenell  
p. 168

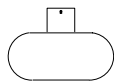

**FONTANELLA**  
Federico Peri  
p. 170



**LUNAIRE**  
Ferréol Babin  
p. 172



**PALLINA**  
FontanaArte Design Lab  
p. 174

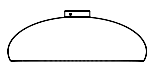

**PANGEN**  
Historical Archive  
p. 176



**SILLABA**  
Piero Castiglioni  
p. 178



**SOLE**  
Bernardino Amato  
p. 180



**TROPICO**  
Gabriele e Oscar Buratti  
p. 183

# LAMPADE A SOSPENSIONE / SUSPENSION LAMPS



**0024**  
Gio Ponti  
p. 186

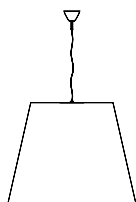

**AMAX**  
Charles Williams  
p. 189

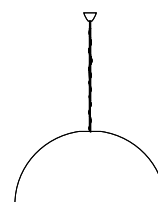

**AVICO**  
Charles Williams  
p. 193



**BIANCA**  
Matti Klenell  
p. 195

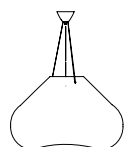

**BOLLA**  
Studio Harry-Paul  
p. 198

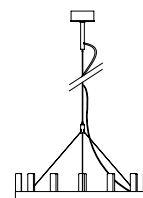

**CHANDELIER**  
David Chipperfield  
p. 200



**EQUATORE**  
Gabriele e Oscar Buratti  
p. 203



**FLÛTE**  
Franco Raggi  
p. 205

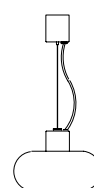

**FONTANELLA**  
Federico Peri  
p. 209



**GLOBO DI LUCE**  
Roberto Menghi  
p. 211

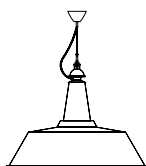

**HUNA**  
Historical Archive  
p. 214

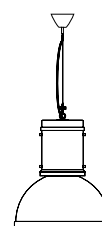

**LAMPARA**  
Historical Archive  
p. 216

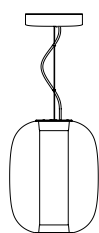

**MERIDIANO**  
Gabriele e Oscar Buratti  
p. 219



**OORT SISTEMA**  
Jacopo Roda  
p. 221



**PALLINA**  
FontanaArte Design Lab  
p. 226

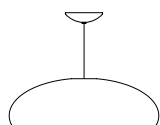

**PANGEN**  
Historical Archive  
p. 228

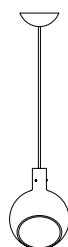

**PAROLA**  
Gae Aulenti e Piero Castiglioni  
p. 230

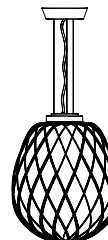

**PINECONE**  
Paola Navone  
p. 232

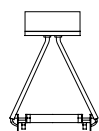

**SCINTILLA**  
Livio e Piero Castiglioni  
p. 235

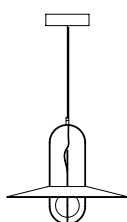

**SETAREH**  
Francesco Librizzi  
p. 237

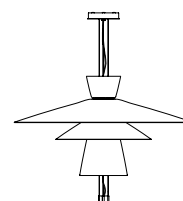

**THALEA**  
Paola Rizzatto &  
Francesco Librizzi  
p. 239

# ARREDO E VASI / FURNITURE & VASES



**CARTOCCIO**  
Pietro Chiesa  
p. 244



**CARTOCCIO Q**  
Pietro Chiesa  
p. 247



**FONTANA**  
Pietro Chiesa  
p. 249



**FONTANA**  
FontanaArte Design Lab  
p. 251

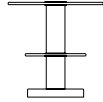

**TAVOLINO 1932**  
Gio Ponti  
p. 253



**TAVOLO CON RUOTE**  
Gae Aulenti  
p. 256



**TESO**  
Renzo Piano  
p. 260

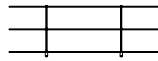

**TESO**  
Renzo Piano  
p. 263

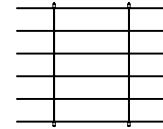

**TESO**  
Renzo Piano  
p. 266

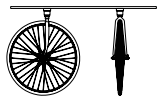

**TOUR**  
Gae Aulenti  
p. 268

# LAMPADE DA TAVOLO / TABLE LAMPS

3247TA	p. 13	PALLINA	p. 63
ASHANGHAI	p. 15	PAROLA	p. 65
BIANCA	p. 17	PINECONE	p. 68
BILIA MINI	p. 19	PIRELLINA	p. 71
BILIA	p. 20	RE	p. 73
BIS / TRIS	p. 22	REGINA	p. 74
BLOM	p. 25	SETAREH	p. 77
BLOM X PARLEY	p. 27	THOR	p. 79
CAMEO	p. 29	TROPICO	p. 81
CHESHIRE	p. 31	UOVO	p. 84
DARUMA	p. 33	UOVO PORTABLE	p. 87
EQUATORE	p. 36	UOVO INDOOR / OUTDOOR	p. 88
FALENA	p. 39	VOLÉE	p. 89
FONTANA	p. 41	DEMI VOLÉE	p. 89
FONTANELLA	p. 44		
GIOVA	p. 46		
LOOP	p. 49		
MANO	p. 51		
MERIDIANO	p. 54		
METAFORA	p. 56		
NASKA	p. 59		





# 3247TA

Historical Archive, 1954





Famiglia di lampade, che comprende la versione da terra e da tavolo, rieditata dall'archivio storico di FontanaArte. Dalle proporzioni ben calibrate e dal design semplice e raffinato, queste lampade creano atmosfere dai toni soffici e armoniosi.

Lampada da tavolo a luce diffusa dimmerabile a pulsante. Montatura in metallo nichelato spazzolato. Diffusore in vetro soffiato satinato bianco. Cavo di alimentazione, dimmer e spina neri. Spina europea due poli.

Family of lamps, which includes the floor and table version, re-edited by the FontanaArte historical archive. With well-balanced proportions and a simple and refined design, these lamps create atmospheres with soft and harmonious tones.

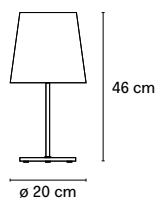
Table lamp with diffused light and dimmable by switch button. Frame made of brushed nickel-plated metal. Opaline blown glass diffuser. Black power cable, dimmer and plug. European two-pole plug.



Codice Code	Materiale Material	Colore Colour	Sorgente luminosa Light source	Dimmer Dimmer	Prezzo no IVA Price VAT excluded
F324700150KBNE	Vetro, Metallo Glass, Metal	 Nichel, Bianco Nickel, White	1x max 57W E27		410,00 €





VETRO SOFFIATO  
BLOWN GLASS

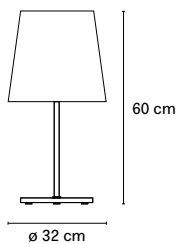

CE Classe A ENEC IP20



Codice Code	Materiale Material	Colore Colour	Sorgente luminosa Light source	Dimmer Dimmer	Prezzo no IVA Price VAT excluded
F324710150KBNE	Vetro, Metallo Glass, Metal	 Nichel, Bianco Nickel, White	1x max 100W E27		574,00 €



VETRO SOFFIATO  
BLOWN GLASS



CE Classe A ENEC IP20



# ASHANGHAI

Max Ingrand, 1955



Questa elegantissima lampada da tavolo è firmata Max Ingrand e il suo disegno risale al 1955, periodo in cui il maestro francese ricopriva in FontanaArte il ruolo di direttore artistico. Giunti in ottone cromato tengono assieme cinque tubi in vetro borosilicato trasparente che, in un gioco di intersezioni, sorreggono la lampada.

Lampada da tavolo a luce diffusa e dimmerabile tramite pulsante. Montatura in ottone cromato. Diffusore principale in vetro soffiato incamiciato bianco acidato. Chiusura diffusore superiore in vetro float in lastra sabbata sui 2 lati. Base realizzata con tubi in vetro borosilicato trasparente. Giunti di fissaggio in ottone cromato. Cavo di alimentazione, dimmer e spina trasparenti. Spina europea a due poli.

This extremely elegant table lamp was designed by Max Ingrand in 1955, during the period when this French maestro was artistic director at FontanaArte. Chromed brass joints hold together five tubes made of transparent borosilicate glass that form a series of intersections supporting the lamp.

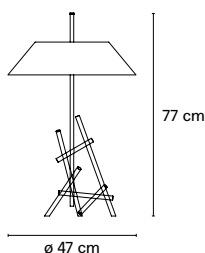
Table lamp with diffused light and dimmable by switch button. Frame in chrome-plated brass. Main diffuser in white acid-etched cased blown glass. Top of diffuser in float glass sheet sandblasted on both sides. Base made from transparent borosilicate glass. Fixing points in chrome-plated brass. Transparent power cable, dimmer and plug. European two-pole plug.



Codice Code	Materiale Material	Colore Colour	Sorgente luminosa Light source	Dimmer Dimmer	Prezzo no IVA Price VAT excluded
F418805150CBNE	Vetro, Metallo Glass, Metal	 Cromo, Bianco Chrome, White	3x max 30W E14		2.336,00 €





# BIANCA

Matti Klenell, 2015

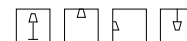

Bianca è una famiglia di lampade la cui decorazione sulla superficie del diffusore è caratterizzata da una serie ordinata di solchi poco profondi e delicati incisi nel vetro bianco, che creano un effetto che ricorda piccole impronte sulla neve fresca. Soffiati a bocca e immersi in acido per ottenere il caratteristico "effetto seta" tipico della vetreria pregiata, i diffusori Bianca sono disponibili in tre diametri diversi per completare tutte le tipologie di lampade appartenenti alla famiglia.

Lampada da tavolo a luce diffusa. Diffusore in vetro in vetro incamiciato di colore bianco latte, soffiato e satinato. Base in metallo bianco. Cavo di alimentazione e spina trasparente. Spina europea a due poli.

Bianca is a family of luminaires with the decoration on the diffuser surface features an orderly series of shallow delicate grooves etched into the white glass, yielding an effect resembling small footprints on fresh snow. Mouth blown and dipped in acid to obtain the distinctive 'silk effect' typical of fine glassware, Bianca diffusers are available in three different diameters to complete all types of luminaires belonging to the family.

Table lamp with diffused light. Glass diffuser made of milky white cased glass, blown and satinfinished. White metal base. Transparent plug and power cord. European two-pole plug.

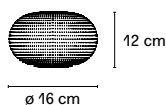

Codice Code	Materiale Material	Colore Colour	Sorgente luminosa Light source	Dimmer Dimmer	Prezzo no IVA Price VAT excluded
F430800150BINE	Vetro, Metallo Glass, Metal	○ Bianco White	1x max 30W G9	⊗	238,00 €

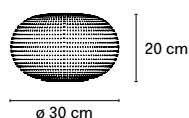

Codice Code	Materiale Material	Colore Colour	Sorgente luminosa Light source	Dimmer Dimmer	Prezzo no IVA Price VAT excluded
F430805150BINE	Vetro, Metallo Glass, Metal	○ Bianco White	1x max 46W E27	⊙	381,00 €

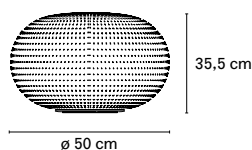

Codice Code	Materiale Material	Colore Colour	Sorgente luminosa Light source	Dimmer Dimmer	Prezzo no IVA Price VAT excluded
F430810150BINE	Vetro, Metallo Glass, Metal	○ Bianco White	1x max 116W E27	⊙	598,00 €



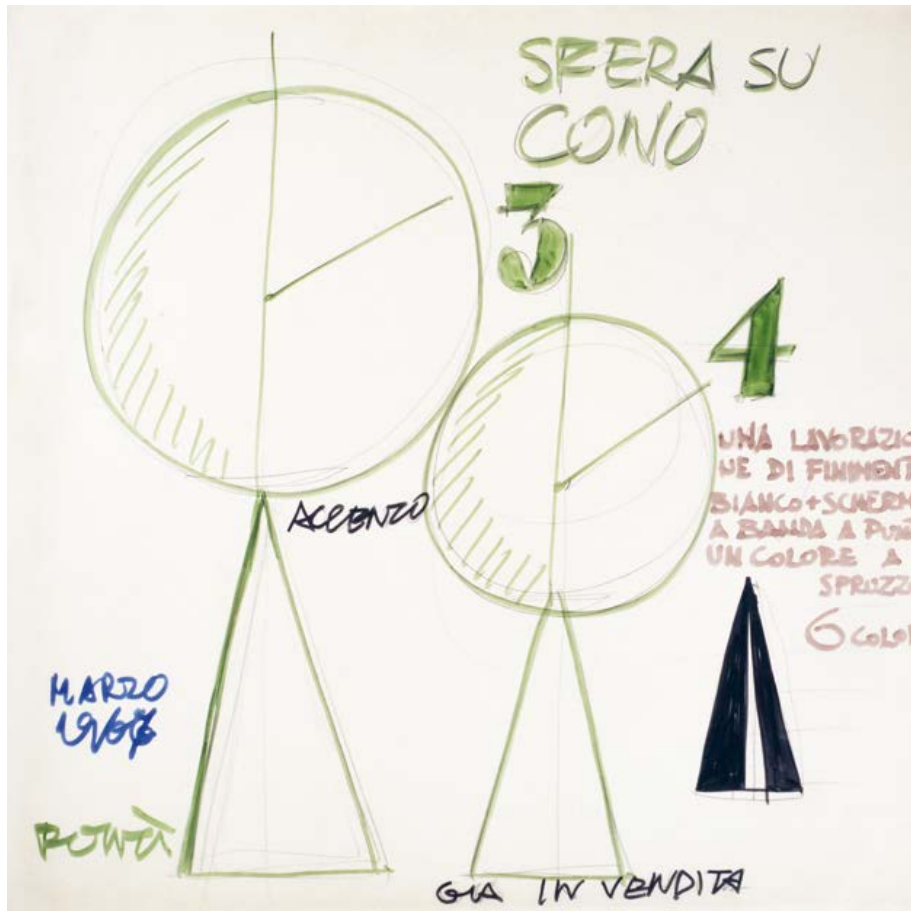







# BILIA

Gio Ponti, 1932

Niente più che una sfera poggiata, in apparente impossibile equilibrio, su un cono che fa da base. Una delle tante magie compositive di Gio Ponti, progettata nel 1932. La contrapposizione di due forme geometriche elementari da origine a un oggetto originale e dalle proporzioni perfette.

Lampada da tavolo a luce diffusa. Montatura in metallo. Diffusore in vetro soffiato bianco satinato. Cavo di alimentazione e spina trasparenti. Spina europea due poli.

Nothing more than a sphere, set in an apparently impossible feat of balance, upon a cone that serves as the base. One of Gio Ponti's many compositional magic tricks, designed in 1932. The counterbalancing of two elementary geometric forms results in an original, perfectly proportioned object.

Table lamp with diffused light. Frame made in metal. Diffuser made of white blown glass with satin-finish. Transparent power cable and plug. European two-pole plug.

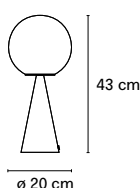

## BILIA

Codice Code	Materiale Material	Colore Colour	Sorgente luminosa Light source	Dimmer Dimmer	Prezzo no IVA Price VAT excluded
F247405150KBNE	Vetro, Metallo Glass, Metal	Nichel, Bianco Nickel, White	1x max 46W E14		484,00 €
F247405150TBNE	Vetro, Metallo Glass, Metal	Ottone, Bianco Brass, White	1x max 46W E14		533,00 €
F247405550NENE	Vetro, Metallo Galvanizzato Glass, Gavanized Metal	Nero lucido Glossy black	1x max 46W E14		574,00 €
F247405550RSNE	Vetro, Metallo Galvanizzato Glass, Gavanized Metal	Rame lucido Glossy copper	1x max 46W E14		574,00 €

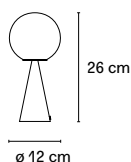

## BILIA MINI

Codice Code	Materiale Material	Colore Colour	Sorgente luminosa Light source	Dimmer Dimmer	Prezzo no IVA Price VAT excluded
F247400150BINE	Vetro, Metallo Glass, Metal	Bianco White	1x max 6W G9		262,00 €
F247400150BLNE	Vetro, Metallo Glass, Metal	Blu Blue	1x max 6W G9		262,00 €
F247400150GINE	Vetro, Metallo Glass, Metal	Giallo Yellow	1x max 6W G9		262,00 €
F247400150KBNE	Vetro, Metallo Glass, Metal	Nichel, Bianco Nickel, White	1x max 6W G9		262,00 €
F247400150NENE	Vetro, Metallo Glass, Metal	Nero Black	1x max 6W G9		262,00 €
F247400150RONE	Vetro, Metallo Glass, Metal	Rosso Red	1x max 6W G9		262,00 €
F247400150VENE	Vetro, Metallo Glass, Metal	Verde Green	1x max 6W G9		262,00 €
F247400150TBNE	Vetro, Metallo Glass, Metal	Ottone, Bianco Brass, White	1x max 6W G9		320,00 €
F247400550NENE	Vetro, Metallo Galvanizzato Glass, Gavanized Metal	Nero lucido Glossy black	1x max 6W G9		320,00 €
F247400550RSNE	Vetro, Metallo Galvanizzato Glass, Gavanized Metal	Rame lucido Glossy copper	1x max 6W G9		320,00 €







# BIS / TRIS

*Historical Archive, 1954*





Progettate nel 1954, le lampade da tavolo Bis e Tris mantengono intatta la loro forma classica e allo stesso tempo contemporanea. Pensate per un raffinato ambiente domestico, trovano la propria perfetta collocazione anche su un tavolo da lavoro o su una elegante consolle.

Lampada da tavolo a luce diretta non dimmerabile. Diffusore inferiore in vetro bianco sabbato. BIS, montatura in ottone lucido. Coppa in vetro opale nero, sabbato e verniciata nera internamente. TRIS, montatura in metallo cromato. Coppa in vetro, sabbato e verniciata bianca internamente. Cavo di alimentazione, interruttore e spina neri. Spina europea due poli.

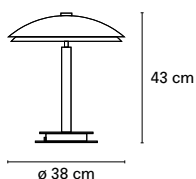
Designed in 1954, the Bis and Tris table lamps maintain their classic yet contemporary shape intact. Designed for a refined home environment, they also find their perfect location on a work table or on an elegant console.

Table lamp with direct light not dimmable. Lower diffuser in white sandblasted glass. BIS, polished brass frame. Bowl in black opaline glass, sandblasted and black interior finish. TRIS, chromed metal frame. Glass bowl, sandblasted and white interior finish. Black power cable, plug and switch. European two-pole plug.



Codice Code	Materiale Material	Colore Colour	Sorgente luminosa Light source	Dimmer Dimmer	Prezzo no IVA Price VAT excluded
F228005150TNNE	Vetro, Metallo Glass, Metal	 Ottone, Nero Brass, Black	4x max 30W E14		951,00 €
F228005150CBNE	Vetro, Metallo Glass, Metal	 Cromo, Bianco Chrome, White	4x max 30W E14		992,00 €



CE EAC Classe II  
IP20



# BLOM

Andreas Engesvik, 2013

Il nome deriva dalla forma della lampada che, dotata di pale simili a petali, ricorda appunto un fiore. La quantità di luce è regolabile grazie ai due petali che avvolgono dolcemente il diffusore e che ruotando sulla base, consentono di schermare il flusso luminoso, personalizzandolo a seconda delle esigenze.

Lampada da tavolo a luce diffusa regolabile tramite la rotazione dei petali sulla base. Montatura in alluminio verniciato, petali in policarbonato. Diffusore in polietilene opalino bianco latte. Cavo di alimentazione, interruttore e spina trasparenti. Spina europea due poli.

The name derives from the shape of the lamp which, with petal-like blades, is reminiscent of a flower. The amount of light is adjustable thanks to the two petals that gently wrap around the diffuser and which, by rotating on the base, allow the luminous flux to be shielded, customising it according to requirements.

Table lamp with diffused light adjustable by moving the petals. Frame made of painted aluminium with polycarbonate petals. Diffuser made of milk-white and opaline polyethylene. Transparent power cable, plug and switch. European two-pole plug.

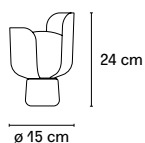

Codice Code	Materiale Material	Colore Colour	Sorgente luminosa Light source	Dimmer Dimmer	Prezzo no IVA Price VAT excluded
F425305350BINE	Polimero, Alluminio Polymer, Aluminum	○ Bianco White	1x max 11W E14	⊗	156,00 €
F425305350BLNE	Polimero, Alluminio Polymer, Aluminum	● Blu Blue	1x max 11W E14	⊗	156,00 €
F425305350GSNE	Polimero, Alluminio Polymer, Aluminum	● Grigio Scuro Dark Gray	1x max 11W E14	⊗	156,00 €
F425305350GINE	Polimero, Alluminio Polymer, Aluminum	● Giallo Yellow	1x max 11W E14	⊗	156,00 €
F425305350VINE	Polimero, Alluminio Polymer, Aluminum	● Viola Violet	1x max 11W E14	⊗	156,00 €
F425305350VENE	Polimero, Alluminio Polymer, Aluminum	● Verde Green	1x max 11W E14	⊗	156,00 €
F425305350RSNE	Polimero, Alluminio Polymer, Aluminum	● Rosa Pink	1x max 11W E14	⊗	156,00 €



CE ENE Classo II  
IP20



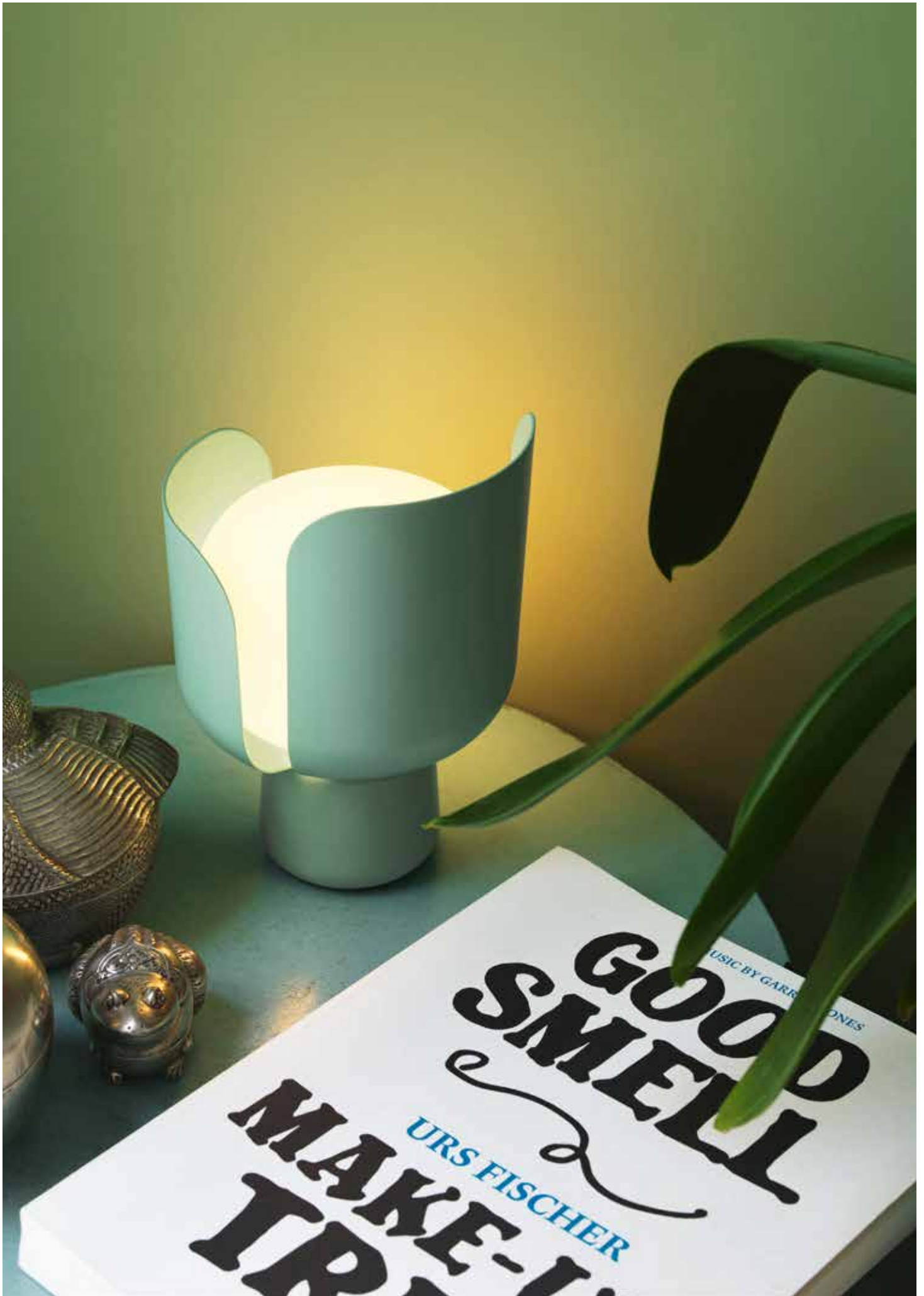

# BLOM for PARLEY

Andreas Engesvik, 2024





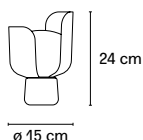

La lampada Blom si rinnova con una versione speciale realizzata in collaborazione insieme a Parley, utilizzando esclusivamente materiali riciclati. Disponibile in tre diverse colorazioni ispirate agli elementi naturali – sabbia, sole e oceano – questa edizione eco-friendly unisce design e sostenibilità. In questa speciale edizione, Blom non solo illumina gli spazi con stile, ma rispecchia anche un impegno verso un futuro più sostenibile.

Lampada da tavolo a luce diffusa regolabile tramite la rotazione dei petali sulla base. Montatura in alluminio verniciato, petali in policarbonato riciclato. Diffusore in polietilene opalino bianco latte. Cavo di alimentazione, interruttore e spina trasparenti. Spina europea due poli.

The Blom lamp gets a makeover with a special version produced in collaboration with Parley, using exclusively recycled materials. Available in three different colours inspired by natural elements - sand, sun and ocean - this eco-friendly edition combines design and sustainability. In this special edition, Blom not only illuminates spaces with style, but also reflects a commitment to a more sustainable future.

Table lamp providing diffused light that can be adjusted by rotating the petals on the base. Painted aluminium frame, recycled polycarbonate petals. Milk-white opal polyethylene diffuser. Transparent power cable, switch and plug. Two-pole European plug.



Codice Code	Materiale Material	Colore Colour	Sorgente luminosa Light source	Dimmer Dimmer	Prezzo no IVA Price VAT excluded
F425305350TPNE	Plastica riciclata, alluminio Recycled plastic, Aluminum	 Turchese RAL6034 Turquoise	1x max 11W E14		180,00 €
F425305350ACNE	Plastica riciclata, alluminio Recycled plastic, Aluminum	 Avorio chiaro RAL1015 Light Ivory	1x max 11W E14		180,00 €
F425305350RBNE	Plastica riciclata, alluminio Recycled plastic, Aluminum	 Rosso beige RAL3012 Salmon	1x max 11W E14		180,00 €





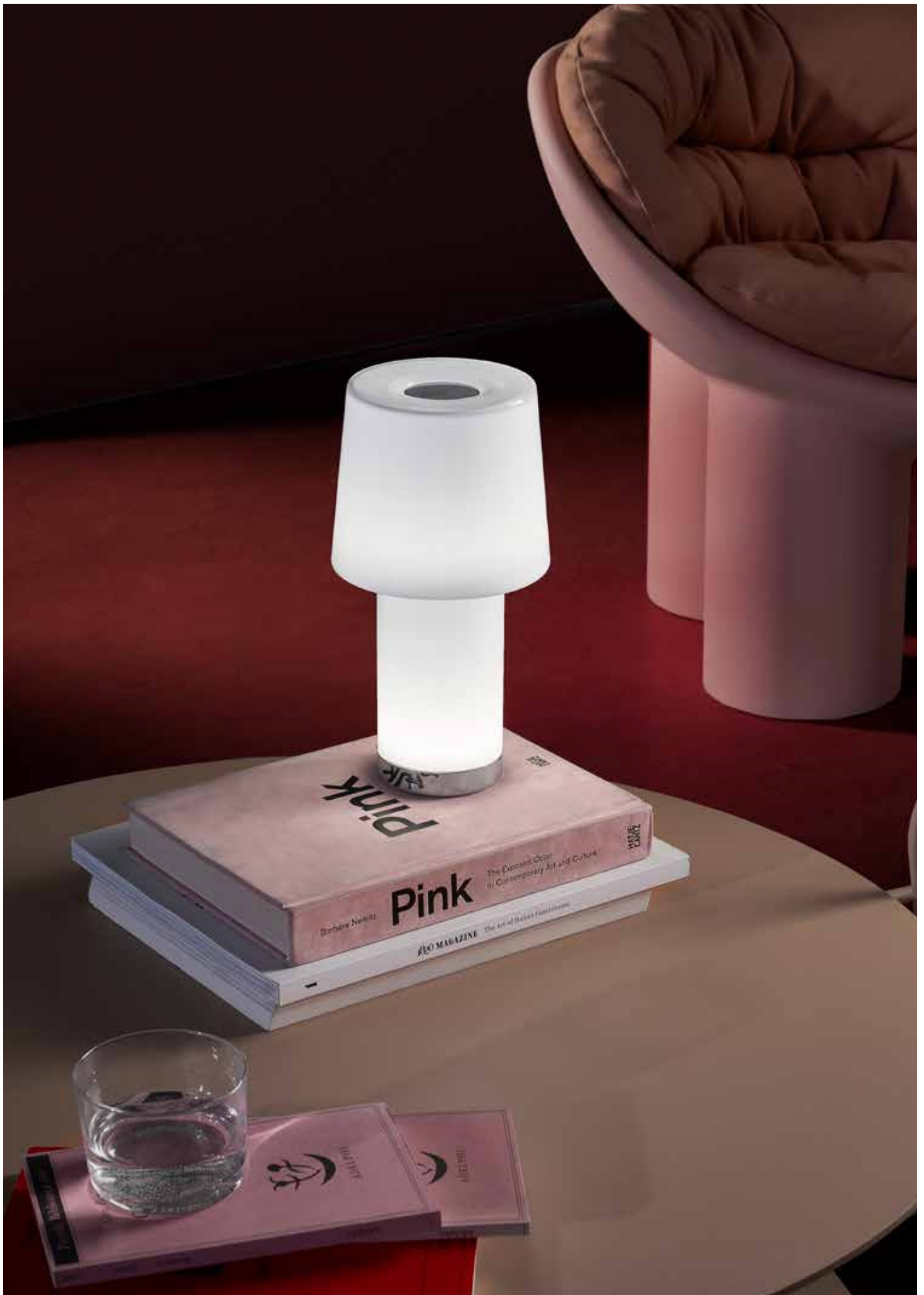

# CAMEO

*Claesson Koivisto Rune, 2023*

Così come quando si parla di “cameo” in un film o opera teatrale, si intende la breve e discreta apparizione di un personaggio famoso, allo stesso modo CAMEO è una lampada di carattere e personalità, essenziale e fondamentale nella sua funzione pur senza essere la protagonista dell’ambiente.

Lampada da tavolo ricaricabile, in vetro soffiato. Disponibile in due versioni: in vetro soffiato bianco lucido abbinato a una montatura in metallo cromato e in vetro soffiato satinato abbinato a una montatura in metallo verniciata in oro satinato. Il cerchio metallico decorativo, posizionato sul diffusore, è realizzato nello stesso materiale e finitura della base e riporta il logo FontanaArte serigrafato. Un pulsante touch trasparente permette l’accensione, lo spegnimento e la regolazione dell’intensità della luce. La lampada è alimentata da una batteria della durata di 8 ore e ricaricabile mediante cavo con presa USB incluso nella confezione. Alimentatore su spina non incluso nella confezione. Uso interno/esterno.

Just as when we speak of a ‘cameo’ in a film or play, we mean the brief and discreet appearance of a famous character; in the same way CAMEO is a lamp with character and personality, essential and fundamental in its function without being the star of the room.

Rechargeable table lamp, made of blown glass. Available in two versions: glossy white blown glass paired with a chrome metal frame, and satin-finished blown glass paired with a satin gold painted metal frame. The decorative metal ring, positioned on the diffuser, is made of the same material and finish as the base and features the serigraphed FontanaArte logo. A transparent touch button allows switching on and off and adjusting the light intensity. The lamp is powered by an 8-hour battery and rechargeable via a cable with USB plug included in the package. Plug-in power supply not included in the package. Indoor/outdoor use.

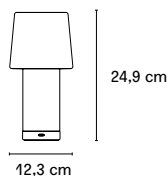

Codice Code	Materiale Material	Colore Colour	Sorgente luminosa Light source	Dimmer Dimmer	Prezzo no IVA Price VAT excluded
F448005550CRBW	Vetro, Metallo Galvanizzato Glass, Galvanized Metal	● Bianco lucido, Cromo Glossy white, Chrome	LED 2x0,7W (2700K, CRI>80, 220Lm)	✓ Touch Touch	328,00 €
F448005160OOBW	Vetro, Metallo Verniciato Glass, Painted Metal	● Bianco satinato, Oro Satin white, Gold	LED 2x0,7W (2700K, CRI>80, 220Lm)	✓ Touch Touch	328,00 €







Riflette l'impronta nordica dello studio nella semplicità dell'estetica e della funzionalità. La calotta è di policarbonato opalino per favorire l'emissione diffusa; colorato per diffondere la luce verso il basso nella versione da tavolo e da terra oppure opalina nella versione sospesa.

Lampada da tavolo a luce diretta non dimmerabile. Diffusore inferiore opalino. Paralume in policarbonato, stelo e base in metallo. Cavo, interruttore e spina trasparenti. Spina europea due poli.

It reflects the firm's Nordic imprint in the simplicity of aesthetics and functionality. The dome is made of opal polycarbonate to encourage diffuse emission; coloured to diffuse the light downwards in the table and floor versions or opal in the suspended version.

Table lamp providing direct non-dimmable light. Opal lower diffuser. Polycarbonate shade, metal stem and base. Transparent cable, switch and plug. Two-pole European plug.

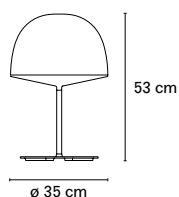

Codice Code	Materiale Material	Colore Colour	Sorgente luminosa Light source	Dimmer Dimmer	Prezzo no IVA Price VAT excluded
F425105350BINE	Polimero, Metallo Polymer, Metal	○ Bianco White	3x max 23W E27	⊗	426,00 €
F425105350NENE	Polimero, Metallo Polymer, Metal	● Nero Black	3x max 23W E27	⊗	426,00 €



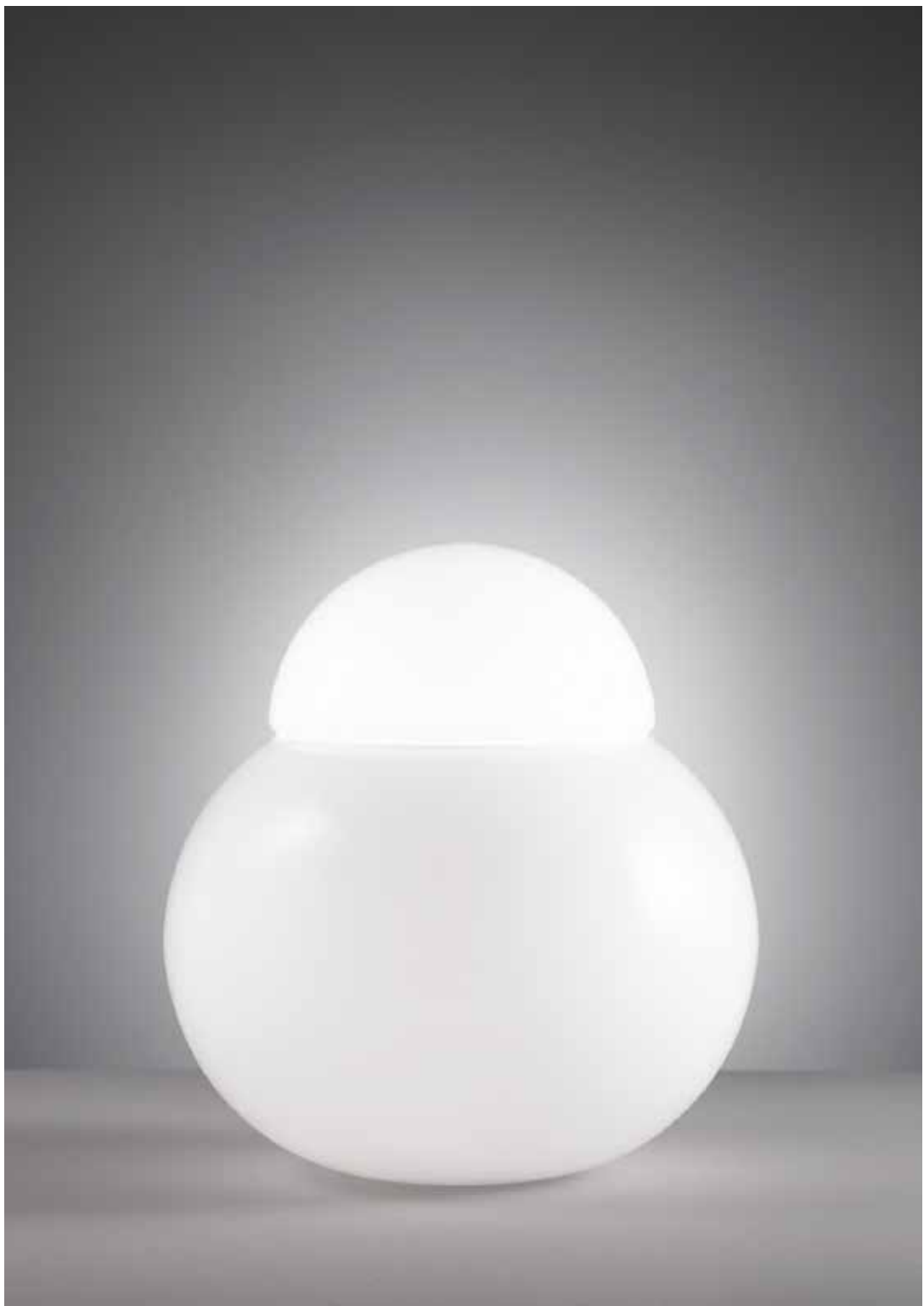



# DARUMA

Sergio Asti, 1968

Daruma è nata così. Due calotte di vetro soffiato bianco lucido che si sovrappongono, dove il rigore dei volumi candidi le conferisce, da spenta, la bellezza elegante di un vaso ma una volta accesa, la anima di luminosità e colorazioni differenti, più intensa nella parte superiore e più soffusa in quella inferiore; un effetto dovuto alla scelta di sistemare la sorgente luminosa nella calotta della lampada. In questo modo il doppio spessore del vetro rifrange diverse intensità, creando effetti luminosi morbidi e accoglienti.

Lampada da tavolo a luce diffusa non dimmerabile. Diffusori in vetro soffiato bianco lucido. Cavo di alimentazione, interruttore e spina neri. Spina europea due poli.

Daruma was born like this. Two glossy white blown glass caps overlapping each other, where the rigour of the white volumes gives it, when switched off, the elegant beauty of a vase, but once switched on, animates it with different luminosity and colours, more intense in the upper part and softer in the lower part; an effect due to the choice of placing the light source in the lamp cap. In this way, the double thickness of the glass refracts different intensities, creating soft and welcoming lighting effects.

Table lamp providing diffused, non-dimmable light. Glossy white blown glass diffusers. Black power cable, switch and plug. Two-pin European plug. Light source not included.

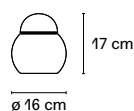

Codice Code	Materiale Material	Colore Colour	Sorgente luminosa Light source	Dimmer Dimmer	Prezzo no IVA Price VAT excluded
F502800100BINE	Vetro Glass	○ Bianco White	1x max 20W E27	⊗	266,00 €

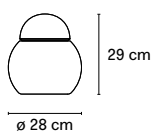

Codice Code	Materiale Material	Colore Colour	Sorgente luminosa Light source	Dimmer Dimmer	Prezzo no IVA Price VAT excluded
F502805100BINE	Vetro Glass	○ Bianco White	1x max 46W E27	⊗	410,00 €

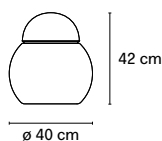

Codice Code	Materiale Material	Colore Colour	Sorgente luminosa Light source	Dimmer Dimmer	Prezzo no IVA Price VAT excluded
F502810100BINE	Vetro Glass	○ Bianco White	1x max 100W E27	⊗	705,00 €











# EQUATORE

Gabriele e Oscar Buratti, 2017



Reinterpretazione in chiave contemporanea delle classiche lampade con paralume in vetro. Se nelle tradizionali abat-jour il diffusore alloggia al suo interno la sorgente luminosa, in questa famiglia di lampade il diffusore è paradossalmente e suggestivamente vuoto e l'effetto luminoso è prodotto da due dischi luminosi all'interno di una fascia metallica centrale, visibile sul paralume e che richiama la linea dell'equatore.

Lampada da tavolo a luce diffusa dimmerabile prodotta da led inseriti all'interno di due dischi in policarbonato sovrapposti. Il disco inferiore produce un'emissione luminosa verso il basso, quello superiore illumina la calotta di vetro colorato. Montatura in metallo. Diffusore in vetro. Cavo di alimentazione, dimmer e spina neri. Alimentatore su spina con plug intercambiabili (uk - usa - europa).

A contemporary reinterpretation of the classic lamp with glass shade. While in traditional abat-jours the diffuser houses the light source inside, in this family of lamps the diffuser is paradoxically and suggestively empty and the luminous effect is produced by two luminous discs within a central metal band, visible on the lampshade and recalling the line of the equator.

Table lamp with dimmable diffused light produced by LEDs inserted inside two superimposed polycarbonate discs. The lower disc produces a downward light emission, the upper one illuminates the coloured glass canopy. Metal frame. Glass diffuser. Black power cable, dimmer and plug. Power supply on plug with interchangeable plugs (uk - usa - europe).

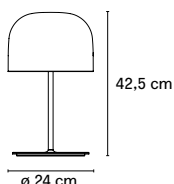

Codice Code	Materiale Material	Colore Colour	Sorgente luminosa Light source	Dimmer Dimmer	Prezzo no IVA Price VAT excluded
F438900550CRWL	Vetro, Metallo Galvanizzato Glass, Galvanized Metal	Cromo Chrome	LED 25W (2700K, CRI>90, 2900Lm)		1.164,00 €
F438900550NEWL	Vetro, Metallo Galvanizzato Glass, Galvanized Metal	Nero lucido Glossy black	LED 25W (2700K, CRI>90, 2900Lm)		1.164,00 €
F438900150OOWL	Vetro, Metallo Glass, Metal	Oro opaco Matt gold	LED 25W (2700K, CRI>90, 2900Lm)		1.025,00 €
F438900550RSWL	Vetro, Metallo Galvanizzato Glass, Galvanized Metal	Rame lucido Glossy copper	LED 25W (2700K, CRI>90, 2900Lm)		1.164,00 €



Su richiesta tecnologia  
Dali o Casambi  
Dali or Casambi  
technology on request

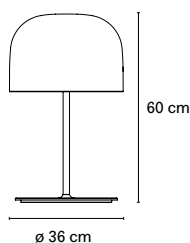

Codice Code	Materiale Material	Colore Colour	Sorgente luminosa Light source	Dimmer incluso Dimmer included	Prezzo no IVA Price VAT excluded
F438905550CRWL	Vetro, Metallo Galvanizzato Glass, Galvanized Metal	Cromo Chrome	LED 40W (2700K, CRI>90, 4500Lm)		1.680,00 €
F438905550NEWL	Vetro, Metallo Galvanizzato Glass, Galvanized Metal	Nero lucido Glossy black	LED 40W (2700K, CRI>90, 4500Lm)		1.680,00 €
F438905150OOWL	Vetro, Metallo Glass, Metal	Oro opaco Matt gold	LED 40W (2700K, CRI>90, 4500Lm)		1.525,00 €
F438905550RSWL	Vetro, Metallo Galvanizzato Glass, Galvanized Metal	Rame lucido Glossy copper	LED 40W (2700K, CRI>90, 4500Lm)		1.680,00 €



Su richiesta tecnologia  
Dali o Casambi  
Dali or Casambi  
technology on request



# FALENA

Alvaro Siza, 1994



Leggerezza ed eleganza in questa famiglia di lampade disegnata da Alvaro Siza e disponibili nella versione da tavolo e parete. Corpo e alette diffusori orientabili per una gestione totale della luce.

Lampada da tavolo a luce direzionabile a doppia intensità non dimmerabile. Montatura in metallo cromato con base in vetro float molato con corpo orientabile a 360°. Alette diffusori, orientabili, in alluminio anodizzato. Schermo di protezione lampadina in vetro sabbato. Il collegamento elettrico fra lo stelo e il corpo avviene tramite jack. Cavo di alimentazione, dimmer e spina neri. Alimentatore su spina europea a due poli.

Lightness and elegance for this family of lamps designed by Alvaro Siza and available table and wall versions. Adjustable body and diffuser wings for complete management of light.

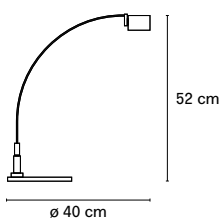
Table lamp directional light and double light intensity not dimmable. Frame made of chromed metal with 360° adjustable body. Cut float glass base. Pivoting diffuser fins made of anodized aluminium. Protection screen of the bulb made of sandblasted glass. Electrical connection between base and body through jack. Black power cable, switch and plug. European two-pole plug power supply.



Codice Code	Materiale Material	Colore Colour	Sorgente luminosa Light source	Dimmer Dimmer	Prezzo no IVA Price VAT excluded
F301705150CRNE	Vetro, Metallo Glass, Metal	 Cromo Chrome	1x max 50W GY6.35		525,00 €



CE ENEC Classe I  
IP20









# FONTANA 1853

Max Ingrand, 1954

Il primo simbolo di oggetto timeless del design, tutt'oggi best seller ed icona intramontabile, Fontana rappresenta l'abat-jour per eccellenza. La peculiarità di Fontana è l'accensione multipla: sia la base, sia il paralume, contengono una o più fonti luminose. L'accensione differenziata permette di incontrare più esigenze d'illuminazione: dal tenue bagliore della luce di riposo, alla luce intensa da lettura fino ad una luce emozionale e d'ambiente, ottenuta per emissione indiretta.

Lampada da tavolo non dimmerabile. Montatura in metallo verniciato. Diffusore e base in vetro soffiato satinato. Cavo di alimentazione, interruttore e spina neri. Spina europea due poli.

The first timeless design object symbol, still a best seller and timeless icon, Fontana represents the abat-jour par excellence. The peculiarity of Fontana is its multiple lighting: both the base and the shade contain one or more light sources. The differentiated switching enables several lighting needs to be met: from the soft glow of the resting light, to the intense reading light up to an emotional and ambient light, obtained by indirect emission.

Non-dimmable table lamp. Painted metal fitting. Satin-blown glass diffuser and base. Black power cable, switch and plug. Two-pin European plug.

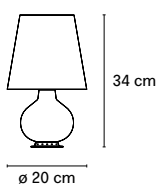

Codice Code	Materiale Material	Colore Colour	Sorgente luminosa Light source	Dimmer Dimmer	Prezzo no IVA Price VAT excluded
F185300100BINE	Vetro Glass	○ Bianco White	1x max 59W E27 + 2x max 19W G9	⊗	488,00 €



Doppia accensione  
Double light controls

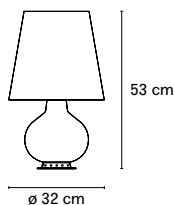

Codice Code	Materiale Material	Colore Colour	Sorgente luminosa Light source	Dimmer Dimmer	Prezzo no IVA Price VAT excluded
F185305100BINE	Vetro Glass	○ Bianco White	1x max 100W E27 + 2x max 30W E14	⊗	734,00 €



Doppia accensione  
Double light controls

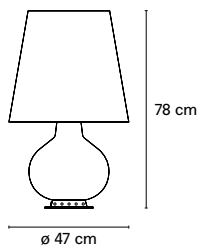

Codice Code	Materiale Material	Colore Colour	Sorgente luminosa Light source	Dimmer Dimmer	Prezzo no IVA Price VAT excluded
F185310100BINE	Vetro Glass	○ Bianco White	1x max 100W E27 + 4x max 46W E27 + 3x max 30W E14	⊗	1.352,00 €



Tripla accensione  
Triple light controls







# FONTANELLA

Federico Peri, 2020

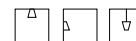

Due materiali: metallo e vetro, come nella storica tradizione di FontanaArte. Il metallo funge da base e contiene la sorgente luminosa mentre il vetro, vero protagonista del progetto, viene sapientemente lavorato da abili artigiani in un processo di fusione fra una porzione di vetro trasparente ed una satinata dalla quale la luce si diffonde. Fontanella è formata dall'unione di due vetri: il tubo interno viene filettato, sabbiato ed infine giuntato con il vetro soffiato a forma di bolla.

Lampada da tavolo a luce diffusa dimmerabile. Montatura in metallo galvanizzato. Diffusore in vetro soffiato in borisilicato. Cavo di alimentazione, dimmer e spina trasparenti. Spina europea due poli.

Two materials: metal and glass, in the historical tradition of FontanaArte. The metal serves as a base and contains the light source, while the glass, the true protagonist of the project, is skilfully worked by skilled artisans in a process of fusion between a portion of transparent glass and a satin-finished one from which the light diffuses. Fontanella is formed by joining two pieces of glass: the inner tube is threaded, sandblasted and finally joined with the blown glass in the shape of a bubble.

Table lamp with dimmable diffused light. Galvanized metal frame. Borisilicate blown glass diffuser. Transparent power cable, dimmer and plug. Two-pin European plug.

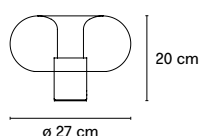

Codice Code	Materiale Material	Colore Colour	Sorgente luminosa Light source	Dimmer Dimmer	Prezzo no IVA Price VAT excluded
F442305550NENE	Vetro, Metallo Galvanizzato Glass, Galvanized Metal	● Nero lucido Glossy black	1x max 28W E14	☑	443,00 €
F442305550OTNE	Vetro, Metallo Galvanizzato Glass, Galvanized Metal	● Ottone spazzolato Glossy Brass	1x max 28W E14	☑	443,00 €

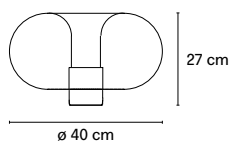

Codice Code	Materiale Material	Colore Colour	Sorgente luminosa Light source	Dimmer Dimmer	Prezzo no IVA Price VAT excluded
F442310550NENE	Vetro, Metallo Galvanizzato Glass, Galvanized Metal	● Nero lucido Glossy black	1x max 77W E27	☑	656,00 €
F442310550OTNE	Vetro, Metallo Galvanizzato Glass, Galvanized Metal	● Ottone spazzolato Glossy Brass	1x max 77W E27	☑	656,00 €







# GIOVA

Gae Aulenti, 1964





Ibrido tra un vaso e una lampada, Giova segna l'esordio di Gae Aulenti nel campo dell'illuminazione d'autore. Disponibile in due dimensioni, è una vera e propria scultura luminosa. Su una base in metallo è posizionato un globo trasparente che include la sfera interna, che alloggia la sorgente luminosa.

Lampada da tavolo a luce diffusa non dimmerabile. Montatura in metallo. Sfera centrale in vetro soffiato trasparente. Sfera interna in vetro soffiato bianco lucido. Semisfera superiore in vetro soffiato pulegoso trasparente colorato. Cavo di alimentazione, interruttore e spina neri. Spina europea due poli.

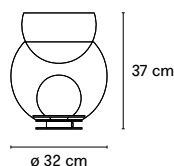



A hybrid between a vase and a lamp, Giova marks Gae Aulenti's debut in the field of designer lighting. Available in two sizes, it is a true light sculpture. A transparent globe is positioned on a metal base, which includes the internal sphere housing the light source.

Table lamp providing diffused, non-dimmable light. Metal fitting. Transparent blown glass central sphere. Glossy white blown glass inner sphere. Transparent coloured blown glass upper hemisphere. Black power cable, switch and plug. Two-pin European plug.

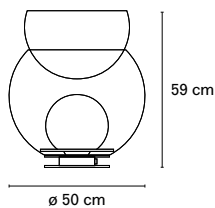

Codice Code	Materiale Material	Colore Colour	Sorgente luminosa Light source	Dimmer Dimmer	Prezzo no IVA Price VAT excluded
F268405150CRNE	Vetro, Metallo Glass, Metal	 Cromo, Rosa Chrome, Pink	1x max 46W E27		984,00 €
F268405575OONE	Vetro, Metallo Galvanizzato Glass, Galvanized Metal	 Oro, Grigio Gold, Gray	11x max 46W E27		1.131,00 €



Codice Code	Materiale Material	Colore Colour	Sorgente luminosa Light source	Dimmer Dimmer	Prezzo no IVA Price VAT excluded
F268410150CRNE	Vetro, Metallo Glass, Metal	 Cromo, Rosa Chrome, Pink	1x max 100W E27		1.434,00 €
F268410575OONE	Vetro, Metallo Galvanizzato Glass, Galvanized Metal	 Oro, Grigio Gold, Gray	1x max 100W E27		1.582,00 €







# LOOP

*Voon Wong & Benson Saw, 2003*

Oggetto luminoso dal fascino unico. Grazie alla rotazione della parte superiore della struttura è possibile la totale regolazione dell'intensità luminosa. Loop si può appoggiare a piacimento su un tavolo oppure a terra.

Lampada da tavolo a luce regolabile mediante rotazione della parte superiore. Montatura in metallo lucidato. Cavo di alimentazione, interruttore e spina trasparenti. Spina europea due poli.

A luminous object with unique appeal. The upper part of the body rotates to allow complete management of the intensity of the light. Loop can be put on a table or on the floor.

Table lamp with adjustable light through rotation of the top part. Glossy metal frame. Transparent power cable, switch and plug. Spina europea due poli.

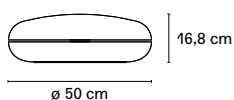

Codice Code	Materiale Material	Colore Colour	Sorgente luminosa Light source	Dimmer Dimmer	Prezzo no IVA Price VAT excluded
F542910200AXLE	Metallo Metal	Acciaio Steel	LED 28,6W (3000K, CRI>80, 3650Lm)	⊗	1.303,00 €



# S. A. LUIGI FONTANA & C.

SEDE CENTRALE: MILANO - VIA PRIVATA G. BUGATTI, 8 - TELEFONI 30-062 - 30-074 - 32-437  
SALA DI ESPOSIZIONE E VENDITA: VIA MONTENAPOLEONE, 21 - TELEFONO 75-089

*Fontana Arte*

CON LA DIREZIONE ARTISTICA DELL'ARCH. GIO PONTI E DI PIETRO CHIESA

*Sede centrale in Milano via privata Bugatti, 8 Telefoni 32-437-30-074-30-082  
Negozio in via del Montenapoleone N°21 - Milano - Telefono N°75089*



LAMPADE - RIVESTIMENTI - MOBILI - VETRATE  
TUTTE LE LAVORAZIONI NOBILI DEL VETRO E DEL CRISTALLO





# MANO

Pietro Chiesa, 1932

Una lampada ironica ed elegante progettata da Pietro Chiesa nel 1932, anno nel quale inizia il suo progetto di direzione artistica in FontanaArte, condivisa con Gio Ponti. Anticipatrice di ironia e di originalità per quei tempi, ancora oggi Mano è fra i pezzi più ricercati dagli appassionati di design di tutto il mondo.

Lampada da tavolo dimmerabile. Base in polvere di marmo e resina e stelo in metallo a sezione quadrata, verniciati entrambi nero opaco "soft". Mano in polvere di marmo e resina colore bianco. Diffusore in tessuto nero accoppiato internamente a PVC bianco. Cavo di alimentazione, interruttore e spina neri. Spina europea due poli.

An ironic and elegant lamp designed by Pietro Chiesa in 1932, the year in which he began his project of artistic direction in FontanaArte, shared with Gio Ponti. Pioneer of irony and originality for those times, Mano is still among the most sought after pieces by design enthusiasts all over the world.

Dimmable table lamp. Marble powder and resin base and square metal stem, both painted 'soft' matt black. White marble powder and resin hand. Black fabric diffuser internally laminated with white PVC. Black power cable, switch and plug. Two-pin European plug.

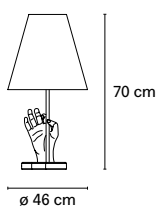

Codice Code	Materiale Material	Colore Colour	Sorgente luminosa Light source	Dimmer Dimmer	Prezzo no IVA Price VAT excluded
F420805400NENE	Metallo, Polvere di Marmo Metal, Marble dust	● Nero Black	1x max 57W E27	☑	533,00 €





# MERIDIANO

Gabriele e Oscar Buratti, 2020





Passando tra layer opalini, colorati e trasparenti, enfatizzata dalle curvature ricercate e dalla magia dei vetri soffiati, la luce è libera di creare effetti, disegni ed atmosfere sorprendenti ed affascinanti. In Meridiano, il tubo cilindrico verticale contiene e diffonde la luce nella capsula di vetro trasparente, che ne definisce la ricercata forma ovoidale.

Lampada da tavolo a luce diffusa dimmerabile. Montatura in metallo nichelato. Diffusore esterno in vetro soffiato. Diffusore interno in vetro pirex verniciato internamente. Cavo di alimentazione, dimmer e spina neri. Alimentatore su spina con plug intercambiabili (uk - usa - europa).

Passing through opal, coloured and transparent layers, emphasised by the refined curves and magic of blown glass, light is free to create surprising and fascinating effects, patterns and atmospheres. In Meridiano, the vertical cylindrical tube contains and diffuses light in the transparent glass capsule, which defines its refined ovoid shape.

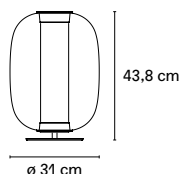
Table lamp providing diffused dimmable light. Nickel-plated metal fitting. Blown glass outer diffuser. Internally painted Pyrex glass diffuser. Black power cable, dimmer and plug. Power supply on plug with interchangeable plugs (uk - usa - europe).



Codice Code	Materiale Material	Colore Colour	Sorgente luminosa Light source	Dimmer Dimmer	Prezzo no IVA Price VAT excluded
F441705550NFWL	Vetro, Metallo Galvanizzato Glass, Galvanized Metal	 Nero, Fumè Black, Grey fumè	LED 25W (2700K, CRI>90, 2900Lm)		1.393,00 €



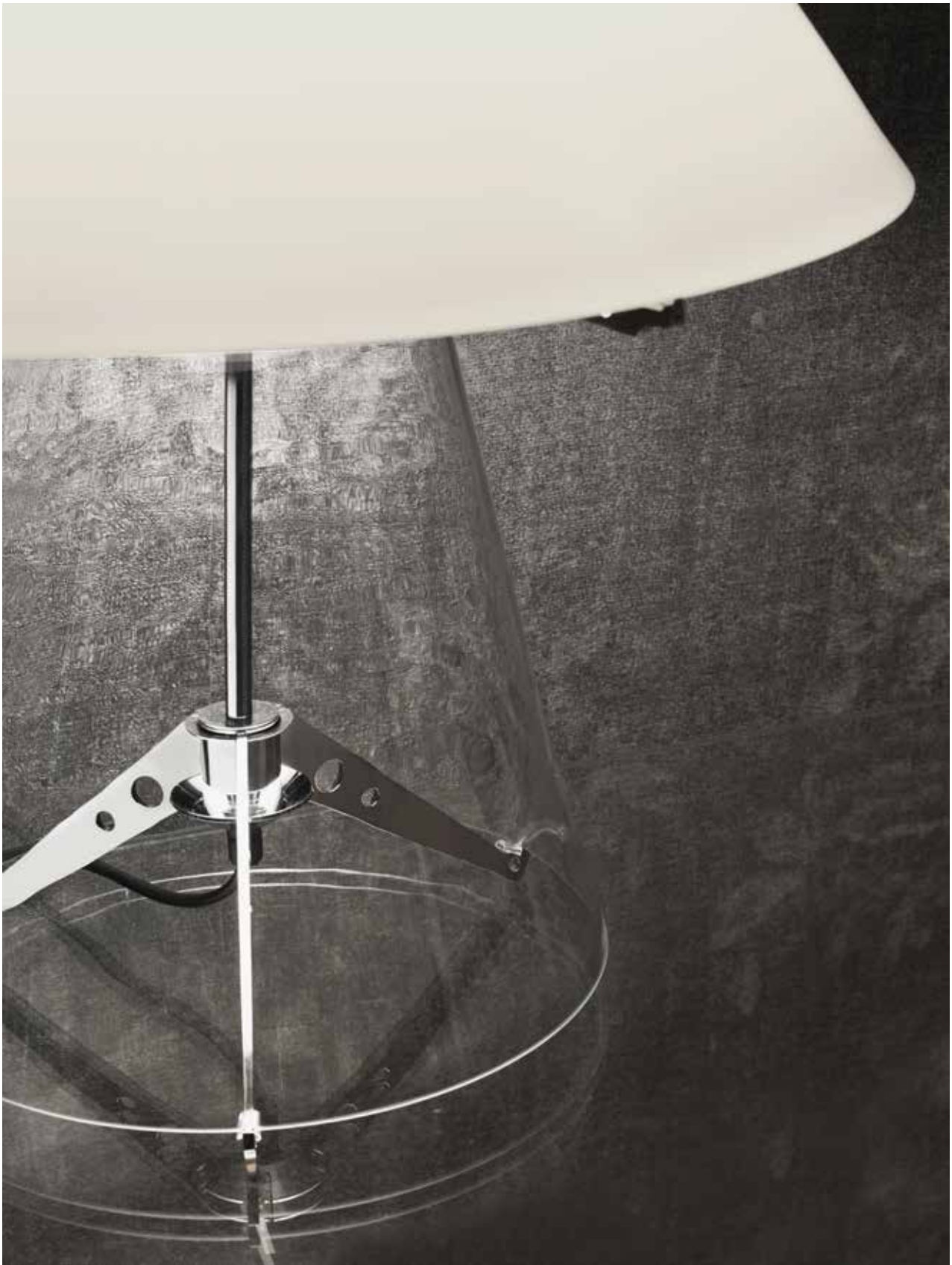





# METAFORA

Umberto Riva, 1980

Una lampada da tavolo preziosa, composta da un diffusore conico a strati di vetro opalino, sorretto da una base in vetro trasparente che cela la struttura in metallo, tutta a incastro. Un oggetto di natura fortemente decorativa, prodotto con tecniche produttive tradizionali come la soffiatura a bocca del vetro.

Lampada da tavolo a luce diffusa dimmerabile. Montatura in metallo cromato. Base in vetro soffiato trasparente. Diffusore in vetro soffiato lucido colorato in pasta. Cavo, dimmer e spina trasparenti. Spina europea due poli.

A precious table lamp, composed of a conical diffuser with layers of opaline glass, supported by a transparent glass base that conceals the metal structure, all interlocking. An object of a highly decorative nature, produced using traditional production techniques such as mouth-blowing glass.

Table lamp providing diffused dimmable light. Chrome metal fitting. Transparent blown glass base. Paste-dyed polished blown glass diffuser. Transparent cable, dimmer and plug. Two-pole European plug.

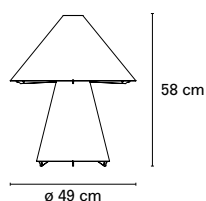

Codice Code	Materiale Material	Colore Colour	Sorgente luminosa Light source	Dimmer Dimmer	Prezzo no IVA Price VAT excluded
F265405150BTNE	Vetro, Metallo Glass, Metal	○ Bianco, Trasparente White, Transparent	1x max 116W E27	☑	885,00 €









# NASKA

*Historical Archive, 1933*

Naska è la lampada da scrivania per eccellenza, l'originale capostipite di tutte le lampade da tavolo con braccio bilanciato a molle. Un oggetto senza tempo, adatto sia per gli spazi domestici che per quelli dedicati al lavoro.

Lampada da tavolo non dimmerabile. Base e stelo in acciaio. Parabola in alluminio. Accensione tramite interruttore a rotazione posto sulla testa del diffusore. Cavo e spina neri. Spina europea due poli.

Naska is the desk lamp par excellence, the original progenitor of all table lamps with a spring-balanced arm. A timeless object, suitable for both home and work spaces.

Non-dimmable table lamp. Steel base and stem. Aluminium parabola. Switched on via rotary switch on the diffuser head. Black cable and plug. Two-pin European plug.



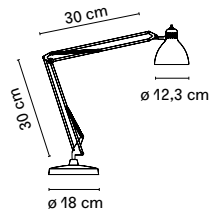

Codice Code	Materiale Material	Colore Colour	Sorgente luminosa Light source	Dimmer Dimmer	Prezzo no IVA Price VAT excluded
F810700200BINE	Metallo Verniciato Painted Metal	○ Bianco White	1x max 30W E27	⊗	398,00 €
F810700240CRNE	Metallo Galvanizzato Galvanized Metal	◐ Cromo Chrome	1x max 30W E27	⊗	475,00 €
F810700200NENE	Metallo Verniciato Painted Metal	● Nero Black	1x max 30W E27	⊗	398,00 €



CE ENEC Classe II IP20

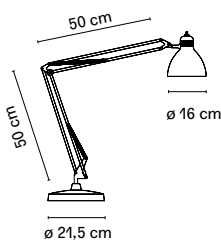

Codice Code	Materiale Material	Colore Colour	Sorgente luminosa Light source	Dimmer Dimmer	Prezzo no IVA Price VAT excluded
F810010200BINE	Metallo Verniciato Painted Metal	○ Bianco White	1x max 46W E27	⊗	447,00 €
F810010240CRNE	Metallo Galvanizzato Galvanized Metal	◐ Cromo Chrome	1x max 46W E27	⊗	516,00 €
F810010200NENE	Metallo Verniciato Painted Metal	● Nero Black	1x max 46W E27	⊗	447,00 €



CE ENEC Classe II IP20

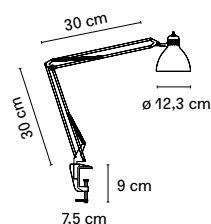

Codice Code	Materiale Material	Colore Colour	Sorgente luminosa Light source	Dimmer Dimmer	Prezzo no IVA Price VAT excluded
F810100200BINE	Metallo Verniciato Painted Metal	○ Bianco White	1x max 30W E27	⊗	352,00 €
F810100240CRNE	Metallo Galvanizzato Galvanized Metal	◐ Cromo Chrome	1x max 30W E27	⊗	406,00 €
F810100200NENE	Metallo Verniciato Painted Metal	● Nero Black	1x max 30W E27	⊗	352,00 €



CE ENEC Classe II IP20

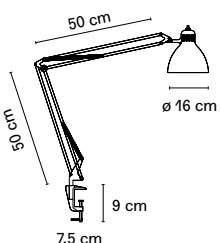

Codice Code	Materiale Material	Colore Colour	Sorgente luminosa Light source	Dimmer Dimmer	Prezzo no IVA Price VAT excluded
F810110200BINE	Metallo Verniciato Painted Metal	○ Bianco White	1x max 46W E27	⊗	361,00 €
F810010240CRNE	Metallo Galvanizzato Galvanized Metal	◐ Cromo Chrome	1x max 46W E27	⊗	443,00 €
F810110200NENE	Metallo Verniciato Painted Metal	● Nero Black	1x max 46W E27	⊗	361,00 €



CE ENEC Classe II IP20



# PALLINA

FontanaArte Design Lab, 2019



La perfezione del vetro e della sfera si uniscono nell'oggetto più essenziale della collezione, un vero e proprio must-have ideale per ogni angolo della casa. Pallina. Una, nessuna, centomila.

Lampada da tavolo a luce diffusa non dimmerabile. Montatura in metallo. Diffusore in vetro soffiato satinato opalino. Cavo, interruttore e spina trasparenti. Spina europea due poli.

The perfection of glass and sphere come together in the most essential object in the collection, a real must-have for every corner of the house. Pallina. One, none, a hundred thousand.

Table lamp providing diffused, non-dimmable light. Metal fitting. Satin-finish opal blown glass diffuser. Transparent cable, switch and plug. Two-pole European plug.

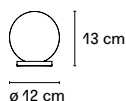

Codice Code	Materiale Material	Colore Colour	Sorgente luminosa Light source	Dimmer Dimmer	Prezzo no IVA Price VAT excluded
F443000150NENE	Vetro, Metallo Galvanizzato Glass, Galvanized Metal	● Nero lucido Glossy black	1x max 6W G9	⊗	172,00 €
F443000150NSNE	Vetro, Metallo Galvanizzato Glass, Galvanized Metal	● Nichel lucido Glossy nickel	1x max 6W G9	⊗	172,00 €
F443000150OTNE	Vetro, Metallo Galvanizzato Glass, Galvanized Metal	● Ottone satinato Satin brass	1x max 6W G9	⊗	172,00 €





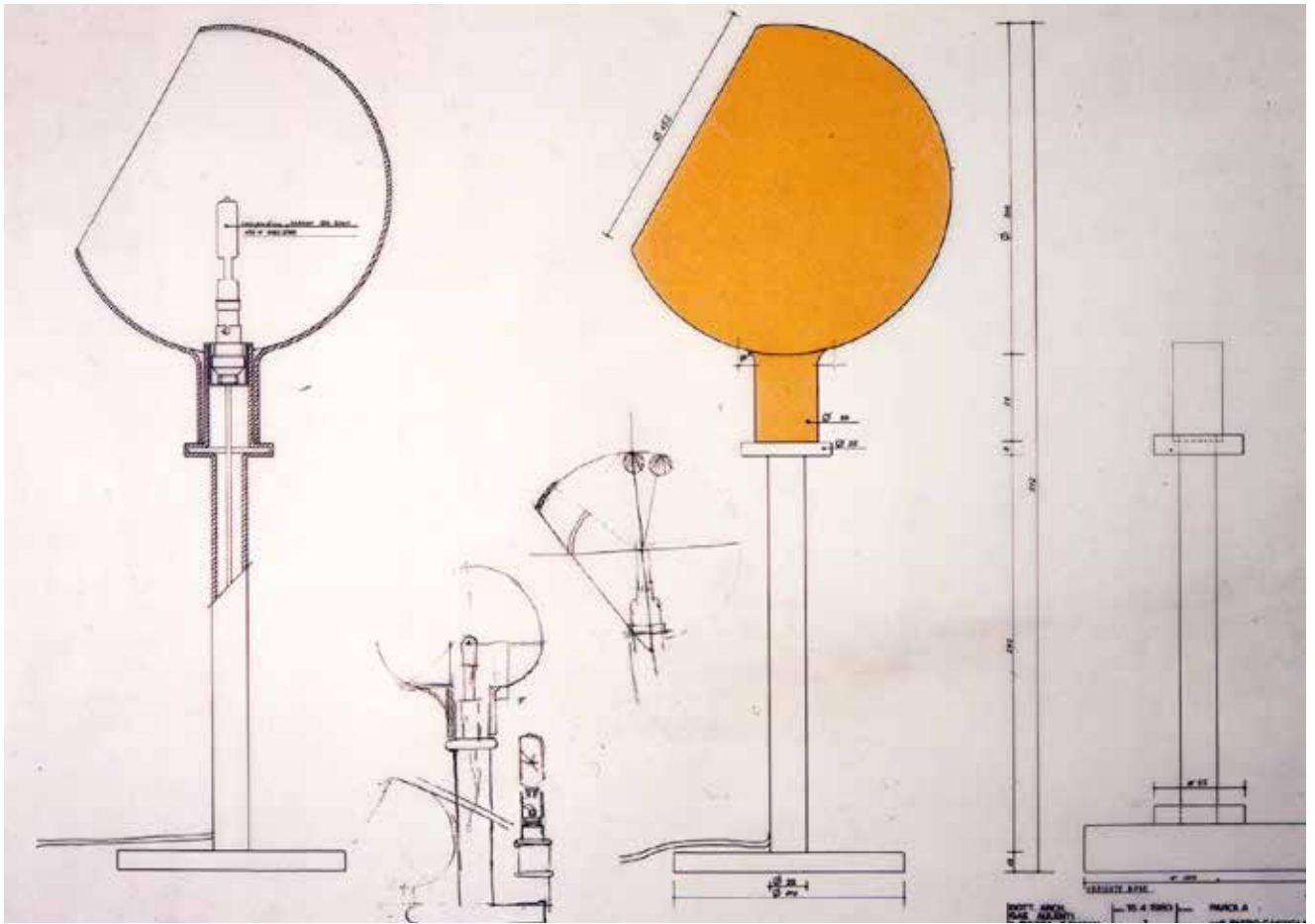





# PAROLA

*Gae Aulenti e Piero Castiglioni, 1980*

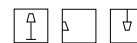

Nella lampada Parola, convivono in un solo oggetto tre diverse tipologie e lavorazioni del vetro: soffiato, borosilicato tornito e in lastra molato naturale. Rappresenta un modello esemplare di integrazione tecnica fra artigianato e industria.

Lampada da tavolo a luce diffusa dimmerabile. Montatura in vetro borosilicato. Diffusore in vetro soffiato lucido colorato in pasta. Base in vetro trasparente molato. Cavo di alimentazione in tessuto tigrato, dimmer e spina neri. Spina europea due poli.

In the Parola lamp, three different types and processes of glass coexist in a single object: blown, turned borosilicate and natural ground sheet. It represents an exemplary model of technical integration between craftsmanship and industry.

Table lamp providing diffused dimmable light. Borosilicate glass fitting. Paste-dyed polished blown glass diffuser. Bevelled transparent glass base. Striped fabric power cable, black dimmer and plug. Two-pole European plug.

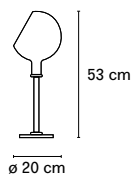

Codice Code	Materiale Material	Colore Colour	Sorgente luminosa Light source	Dimmer Dimmer	Prezzo no IVA Price VAT excluded
F265805100AMNE	Vetro Glass	● Ambra Amber	1x max 46W E14	✓	746,00 €
F265805100BINE	Vetro Glass	○ Bianco White	1x max 46W E14	✓	746,00 €









# PINECONE

Paola Navone, 2016

Pinecone è una lampada da sospensione e da appoggio con un diffusore realizzato tramite l'antica tecnica del vetro soffiato ingabbiato. Il maestro vetraio soffia la bolla vitrea in una gabbia metallica, che ne contiene parzialmente l'espansione, creando un effetto di tensione tra il vetro e la gabbia. Quest'ultima viene ulteriormente valorizzata da un trattamento galvanico che la rende lucida e brillante.

Lampada da tavolo a luce diffusa dimmerabile. Diffusore in vetro soffiato ingabbiato. Gabbia e base in metallo galvanizzato. Cavo di alimentazione, dimmer e spina trasparenti. Spina europea due poli.

Pinecone is a pendant and floor lamp with a diffuser made using the ancient technique of caged blown glass. The master glassmaker blows the glass bubble into a metal cage, which partially contains its expansion, creating a tension effect between the glass and the cage. The latter is further enhanced by a galvanic treatment that makes it shiny and brilliant.

Table lamp providing diffused dimmable light. Caged blown glass diffuser. Galvanised metal cage and base. Transparent power cable, dimmer and plug. Two-pole European plug.

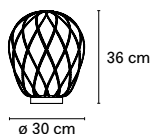

Codice Code	Materiale Material	Colore Colour	Sorgente luminosa Light source	Dimmer Dimmer	Prezzo no IVA Price VAT excluded
F436405550TCNE	Vetro, Metallo Galvanizzato Glass, Galvanized Metal	Trasparente, Cromo Transparent, Chrome	1x max 116W E27	☑	1.434,00 €
F436405550CBNE	Vetro, Metallo Galvanizzato Glass, Galvanized Metal	Bianco, Cromo White, Chrome	1x max 116W E27	☑	1.434,00 €
F436405575TCNE	Vetro, Metallo Galvanizzato Glass, Galvanized Metal	Trasparente, Oro Transparent, Gold	1x max 116W E27	☑	1.516,00 €
F436405575OBNE	Vetro, Metallo Galvanizzato Glass, Galvanized Metal	Bianco, Oro White, Gold	1x max 116W E27	☑	1.516,00 €

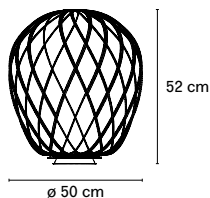

Codice Code	Materiale Material	Colore Colour	Sorgente luminosa Light source	Dimmer Dimmer	Prezzo no IVA Price VAT excluded
F434010550TCNE	Vetro, Metallo Galvanizzato Glass, Galvanized Metal	Trasparente, Cromo Transparent, Chrome	1x max 116W E27	☑	1.762,00 €
F434010550CBNE	Vetro, Metallo Galvanizzato Glass, Galvanized Metal	Bianco, Cromo White, Chrome	1x max 116W E27	☑	1.762,00 €
F434010575TCNE	Vetro, Metallo Galvanizzato Glass, Galvanized Metal	Trasparente, Oro Transparent, Gold	1x max 116W E27	☑	2.082,00 €
F434010575OBNE	Vetro, Metallo Galvanizzato Glass, Galvanized Metal	Bianco, Oro White, Gold	1x max 116W E27	☑	2.082,00 €







# PIRELLINA

Gio Ponti, 1967

Pirellone e Pirellina sono da più di 40 anni dei classici intramontabili dell'illuminazione. Una coppia di lastre di vetro curvate e trattenute in posizione da due elementi metallici, alla base e all'estremità superiore: una struttura semplice, ottenuta grazie all'utilizzo di due vetri curvi.



Lampada da tavolo a luce diffusa dimmerabile. Montatura in metallo nichelato. Diffusore in vetro curvato stampato. Cavo di alimentazione, dimmer e spina trasparenti. Spina europea due poli.

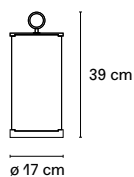

Pirellone and Pirellina have been timeless lighting classics for more than 40 years. A pair of curved glass panes held in place by two metal elements, at the base and at the top: a simple structure achieved through the use of two curved glass panes.

Table lamp providing diffused dimmable light. Nickel-plated metal fitting. Moulded curved glass diffuser. Transparent power cable, dimmer and plug. Two-pole European plug.



Codice Code	Materiale Material	Colore Colour	Sorgente luminosa Light source	Dimmer Dimmer	Prezzo no IVA Price VAT excluded
F278205150KBNE	Vetro, Metallo Glass, Metal	 Nichel, Bianco Nickel, White	4x max 20W E14		418,00 €



CE EAC Classe II  
IP20









# RE & REGINA

*Bobo Piccoli, 1968 Re-Edition*

Ispirate al gioco degli scacchi con le loro forme morbide e sinuose Re e Regina sono i personaggi chiave della scacchiera. I loro profili si stagliano netti nella luce bianca diffusa dal vetro opalescente. Verticale Re, avvitata intorno a un'ampia circonferenza orizzontale Regina. Possono essere collocati l'uno a fianco all'altro, oppure richiamarsi da punti diversi di un ambiente, o anche procedere indipendentemente, ognuna di queste lampade ha una sua personalità.

Lampade da tavolo o da terra a luce diffusa dimmerabile. Montatura in metallo verniciato. Diffusore in vetro soffiato satinato. Cavo di alimentazione, dimmer e spina neri. Alimentatore su spina con plug intercambiabili (europa - usa).

Inspired by the game of chess with their soft, sinuous shapes King and Queen are the key characters of the chessboard. Their profiles stand out sharply in the white light diffused by the opalescent glass. Vertical King, screwed around a wide horizontal Regina circumference. They can be placed side by side, or recall each other from different points in a room, or even proceed independently, each of these lamps has its own personality.

Table or floor lamps providing diffused dimmable light. Painted metal fitting. Satin-blown glass diffuser. Black power cable, dimmer and plug. Power supply on plug with interchangeable plugs (europa - usa).

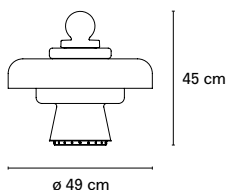

## REGINA

Codice Code	Materiale Material	Colore Colour	Sorgente luminosa Light source	Dimmer Dimmer	Prezzo no IVA Price VAT excluded
F448810100BIWL	Vetro Glass	○ Bianco White	LED 54W (2700K, CRI>85, 5500Lm)	☑	1.762,00 €

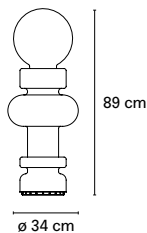

## RE

Codice Code	Materiale Material	Colore Colour	Sorgente luminosa Light source	Dimmer Dimmer	Prezzo no IVA Price VAT excluded
F448910100BIWL	Vetro Glass	○ Bianco White	LED 48W (2700K, CRI>85, 4800Lm)	☑	1.926,00 €





# SETAREH

Francesco Librizzi, 2017



La lampada è composta da una sfera magicamente sospesa all'interno di una struttura metallica sottile. Un gioco di masse e di traiettorie circolari genera un disegno bilanciato di dinamiche gravitazionali. La luce emanata dalla sfera si diffonde sullo spazio circostante e irraggia il telaio. I riflessi del metallo rendono visibile il campo luminoso, lo spazio influenzato dalla luce, la sua aura.

Lampada da tavolo a luce diffusa dimmerabile. Montatura in metallo galvanizzato. Base in marmo. Diffusore sferico in vetro soffiato satinato opalino e diffusore superiore scampanato verniciato internamente e satinato esternamente. Cavo di alimentazione, dimmer e spina neri. Alimentatore su spina con plug intercambiabili (uk - usa - europa).

The lamp consists of a sphere magically suspended within a slender metal structure. An interplay of masses and circular trajectories generates a balanced pattern of gravitational dynamics. The light emanating from the sphere spreads over the surrounding space and irradiates the frame. The reflections of the metal make the light field visible, the space influenced by the light, its aura.

Dimmable diffused light table lamp. Galvanized metal fitting. Marble base. Spherical diffuser in opaline satin-finish blown glass and upper bell-shaped diffuser painted internally and satin-finish externally. Black power cable, dimmer and plug. Power supply on plug with interchangeable plugs (uk - usa - europe).

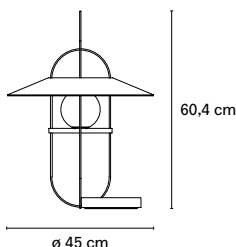

Codice Code	Materiale Material	Colore Colour	Sorgente luminosa Light source	Dimmer Dimmer	Prezzo no IVA Price VAT excluded
F438405500NBWL	Vetro, Metallo Galvanizzato, Marmo Glass, Galvanized Metal, Marble	● Nero lucido, Bianco Glossy black, White	LED 6W (2700K, CRI>80, 830Lm)	✓	1.025,00 €
F438405500OBWL	Vetro, Metallo Galvanizzato, Marmo Glass, Galvanized Metal, Marble	● Oro lucido, Bianco Glossy gold, White	LED 6W (2700K, CRI>80, 830Lm)	✓	1.025,00 €



Base in marmo bianco di Carrara per la versione oro e in grigio Carnico per la versione nero. Base made in white Carrara marble for the gold version and in gray Carnico marble for black version.







# THOR

Pagani Perversi Architects, 2000

Piccola lampada da tavolo dal design semplice e, allo stesso tempo, eccentrico. E' perfetta per valorizzare angoli della casa e complementi d'arredo.

Lampada da tavolo a luce diffusa non dimmerabile. Diffusore in vetro soffiato satinato opalino. Cavo, interruttore e spina trasparenti. Spina europea due poli.

Small table lamp with a simple and at the same time eccentric design. It is perfect for enhancing corners of the house and furnishing accessories.

Table lamp with diffused light not dimmable. Diffuser made of opaline blown glass with satin-finish. Transparent power cable, switch and plug. European two-pole plug.

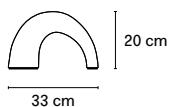

Codice Code	Materiale Material	Colore Colour	Sorgente luminosa Light source	Dimmer Dimmer	Prezzo no IVA Price VAT excluded
F329500100BINE	Vetro Glass	○ Bianco White	1x max 30W E14	⊗	320,00 €

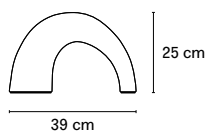

Codice Code	Materiale Material	Colore Colour	Sorgente luminosa Light source	Dimmer Dimmer	Prezzo no IVA Price VAT excluded
F329505100BINE	Vetro Glass	○ Bianco White	1x max 46W E27	⊗	414,00 €



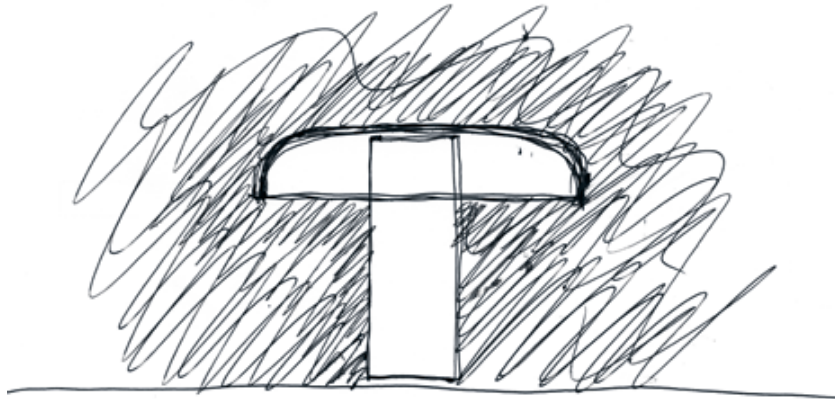
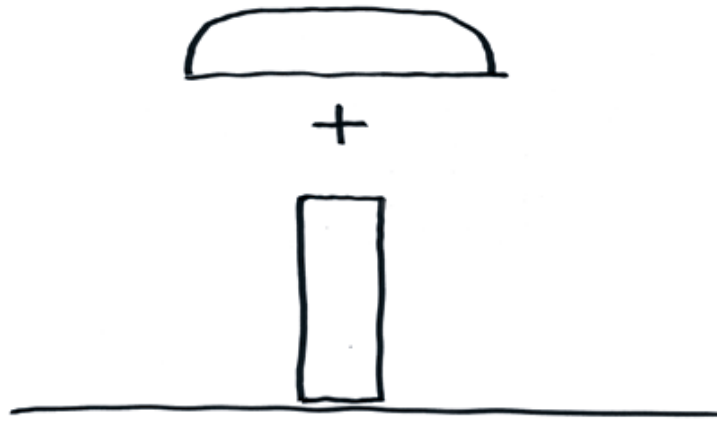



# TROPICO

Gabriele e Oscar Buratti, 2020



Passando tra layer opalini, enfatizzata dalle curvature ricercate e dalla magia dei vetri soffiati, la luce è libera di creare effetti, disegni ed atmosfere sorprendenti ed affascinanti. Tropicico è una calotta sferica in vetro opalino opaco, ribassata e fissata da una grande borchia in metallo galvanizzato.

Lampada da tavolo a luce diffusa dimmerabile. Montatura in marmo. Diffusore in vetro soffiato opalino acidato. Bottone centrale in metallo galvanizzato. Cavo di alimentazione, dimmer e spina neri. Alimentatore su spina con plug intercambiabile (uk - usa - europa).

Passing between opaline layers, emphasised by the refined curvatures and the magic of blown glass, light is free to create surprising and fascinating effects, patterns and atmospheres. Tropicico is a spherical cap in opaque opaline glass, lowered and fixed by a large galvanised metal stud.

Table lamp providing diffused dimmable light. Marble fitting. Acid-etched opaline blown glass diffuser. Galvanised metal central button. Black power cable, dimmer and plug. Power supply on plug with interchangeable plug (uk - usa - europe).

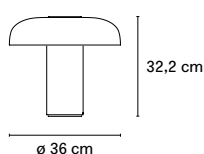

Codice Code	Materiale Material	Colore Colour	Sorgente luminosa Light source	Dimmer incluso Dimmer included	Prezzo no IVA Price VAT excluded
F442105585BIWL	Vetro, Metallo Galvanizzato, Marmo Glass, Galvanized Metal, Marble	Bianco, Oro lucido White, Glossy gold	LED 32W (3000K, CRI>80, 3700Lm)		967,00 €
F442105585GCWL	Vetro, Metallo Galvanizzato, Marmo Glass, Galvanized Metal, Marble	Grigio, Nero lucido Gray, Glossy black	LED 32W (3000K, CRI>80, 3700Lm)		967,00 €
F442105585NEWL	Vetro, Metallo Galvanizzato, Marmo Glass, Galvanized Metal, Marble	Nero, Nero lucido Black, Glossy black	LED 32W (3000K, CRI>80, 3700Lm)		967,00 €



Base in marmo bianco di Carrara con bottone oro, base in marmo grigio Bardiglio e nero Marquinia con bottone nero.  
White Carrara marble base with polished gold button, Bardiglio grey and Marquinia black marble base with polished black button.

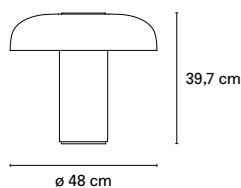

Codice Code	Materiale Material	Colore Colour	Sorgente luminosa Light source	Dimmer incluso Dimmer included	Prezzo no IVA Price VAT excluded
F442110585BIWL	Vetro, Metallo Galvanizzato, Marmo Glass, Galvanized Metal, Marble	Bianco, Oro lucido White, Glossy gold	LED 42W (3000K, CRI>80, 4780Lm)		1.475,00 €
F442110585GCWL	Vetro, Metallo Galvanizzato, Marmo Glass, Galvanized Metal, Marble	Grigio, Nero lucido Gray, Glossy black	LED 42W (3000K, CRI>80, 4780Lm)		1.475,00 €
F442110585NEWL	Vetro, Metallo Galvanizzato, Marmo Glass, Galvanized Metal, Marble	Nero, Nero lucido Black, Glossy black	LED 42W (3000K, CRI>80, 4780Lm)		1.475,00 €



Base in marmo bianco di Carrara con bottone oro, base in marmo grigio Bardiglio e nero Marquinia con bottone nero.  
White Carrara marble base with polished gold button, Bardiglio grey and Marquinia black marble base with polished black button.







# UOVO

Ben Swildens, 1972

Una forma naturale che da sempre è simbolo di perfezione, in cui convivono armonicamente simmetria e asimmetria. Come in natura, anche nella lampada Uovo il guscio è esempio assoluto di leggerezza: una forma elegante in vetro soffiato bianco satinato, che diffonde uniformemente una luce calda e avvolgente.

Lampada da tavolo a luce diffusa dimerabile. Diffusore in vetro soffiato satinato bianco. Base in metallo verniciato bianco. Cavo di alimentazione, dimmer e spina neri. Spina europea due poli.

A natural form and timeless symbol of perfection, in which symmetry and asymmetry harmoniously coexist. As in nature, the shell of the Uovo lamp is the embodiment of absolute lightness, an elegant form in white satin blown glass that gives off a warm, uniform light.

Table lamp with diffused and dimmable light. Diffuser made of white blown glass with satin-finish. Base made of white painted metal. Black power cable, plug and switch. European two-pole plug.

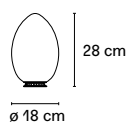

Codice Code	Materiale Material	Colore Colour	Sorgente luminosa Light source	Dimmer Dimmer	Prezzo no IVA Price VAT excluded
F264600100BINE	Vetro Glass	○ Bianco White	1x max 30W E27	☑	266,00 €

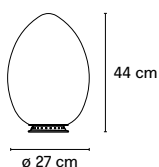

Codice Code	Materiale Material	Colore Colour	Sorgente luminosa Light source	Dimmer Dimmer	Prezzo no IVA Price VAT excluded
F264605100BINE	Vetro Glass	○ Bianco White	1x max 70W E27	☑	344,00 €

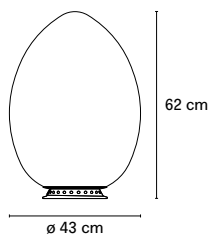

Codice Code	Materiale Material	Colore Colour	Sorgente luminosa Light source	Dimmer Dimmer	Prezzo no IVA Price VAT excluded
F264610100BINE	Vetro Glass	○ Bianco White	1x max 100W E27	☑	590,00 €





# UOVO PORTABLE

*Ben Swildens, 2023*

Lampada da tavolo portatile, in vetro soffiato. Fonte luminosa LED integrato e dimmerabile – Un pulsante touch trasparente permette l'accensione, lo spegnimento e la regolazione dell'intensità della luce. La lampada è alimentata da una batteria della durata di 8 ore e ricaricabile mediante cavo con presa USB incluso nella confezione. Alimentatore su spina non incluso nella confezione. Uso interno/esterno.

Portable table lamp, made of blown glass. Integrated and dimmable LED light source - A transparent touch button allows switching on, switching off and adjusting the light intensity. The lamp is powered by an 8-hour battery and rechargeable via a cable with USB plug included in the package. Plug-in power supply not included in the package. Indoor/outdoor use.

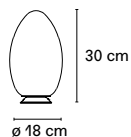

Codice Code	Materiale Material	Colore Colour	Sorgente luminosa Light source	Dimmer Dimmer	Prezzo no IVA Price VAT excluded
F264600150BIBW	Vetro, Metallo Glass, Metal	○ Bianco White	LED 2,2W (250Lm)	☑	324,00 €



durata 8 ore alla  
massima potenza  
8 hours duration at  
maximum power

# UOVO OUTDOOR

*Ben Swildens, 1972*

Lampada da tavolo o da terra da esterno a luce diffusa. Diffusore in polietilene bianco satinato opalino realizzato con stampaggio rotazionale. Montatura in acciaio inox. Cavo di alimentazione nero. Spina di tipo schuko.

Outdoor table or floor lamp providing diffused light. Diffuser in opaline satin white polyethylene made by rotational moulding. Stainless steel fitting. Black power cable. Schuko-type plug.

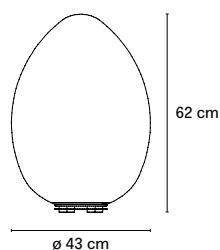

Codice Code	Materiale Material	Colore Colour	Sorgente luminosa Light source	Dimmer Dimmer	Prezzo no IVA Price VAT excluded
F264613370BINE	Polimero, Metallo Polymer, Metal	○ Bianco White	1x max 30W E27	⊗	676,00 €



CE ENEC Classe V IPX4







# VOLÈE

Odo Fioravanti, 2016

Volée è un apparecchio di illuminazione a Led di ultima generazione, nel quale la ricerca formale si coniuga con l'innovazione tecnologica. Caratterizzato da un disegno essenziale, si accende con un gesto quasi tennistico: un semplice movimento della mano sotto la testa attiva un dispositivo elettronico che accende e spegne la lampada senza che essa venga toccata.

Lampada da tavolo a luce diretta. Accensione e regolazione flusso luminoso tramite sensore touch posto sulla testa. Inoltre è possibile accendere e spegnere la lampada passando la mano sotto la testa dell'apparecchio. Montatura composta da una testa e aste strutturali in alluminio verniciato. Cavo di alimentazione e spina neri. Alimentatore su spina con plug intercambiabili (uk - usa - europa).

Volée is a Led luminaire of the latest generation, in which the formal research is combined with technological innovation. Featured by an essential design, Volée switches on with an almost tennis-style gesture: a simple wave of the hand under the head of this lamp activates an electronic device that switches the light on or off without any contact.

Table lamp with direct light. A touch sensor over the head allows the flow of light to be regulated to different levels of intensity. A simple wave of the hand under the head of this lamp activates an electronic device that switches the light on/off without any contact. Frame consist of a head and of structural rods made of painted aluminium. Black power cable and plug. Plug-in power supply with interchangeable plugs (uk - usa - europe).

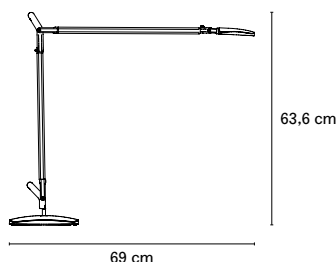

## VOLÈE

Codice Code	Materiale Material	Colore Colour	Sorgente luminosa Light source	Dimmer incluso Dimmer included	Prezzo no IVA Price VAT excluded
F429005350BIWL	Polimero, Metallo Polymer, Metal	○ Bianco White	LED 7,5W (2700K, CRI>90, 800Lm)	☑ Touch Touch	369,00 €
F429005350GIWL	Polimero, Metallo Polymer, Metal	● Giallo Yellow	LED 7,5W (2700K, CRI>90, 800Lm)	☑ Touch Touch	369,00 €
F429005350GSWL	Polimero, Metallo Polymer, Metal	● Grigio scuro Dark gray	LED 7,5W (2700K, CRI>90, 800Lm)	☑ Touch Touch	369,00 €

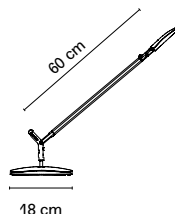

## DEMI VOLÈE

Codice Code	Materiale Material	Colore Colour	Sorgente luminosa Light source	Dimmer incluso Dimmer included	Prezzo no IVA Price VAT excluded
F429000350BIWL	Polimero, Metallo Polymer, Metal	○ Bianco White	LED 7,5W (2700K, CRI>90, 800Lm)	☑ Touch Touch	303,00 €
F429000350GIWL	Polimero, Metallo Polymer, Metal	● Giallo Yellow	LED 7,5W (2700K, CRI>90, 800Lm)	☑ Touch Touch	303,00 €
F429000350GSWL	Polimero, Metallo Polymer, Metal	● Grigio scuro Dark gray	LED 7,5W (2700K, CRI>90, 800Lm)	☑ Touch Touch	303,00 €



## LAMPADE DA TERRA / FLOOR LAMPS

3247	p. 93
BIANCA	p. 95
CHESHIRE	p. 97
EQUATORE	p. 99
FLÛTE	p. 101
LUMEN	p. 104
LUMINATOR	p. 106
MERIDIANO	p. 109
OORT	p. 111
PAROLA	p. 113
PAROLONA	p. 114
PIRELLONE	p. 116
PRIMA SIGNORA	p. 118
VERTIGO	p. 120
YUMI	p. 122







Famiglia di lampade, che comprende la versione da terra e da tavolo, rieditata dall'archivio storico di FontanaArte. Dalle proporzioni ben calibrate e dal design semplice e raffinato, queste lampade creano atmosfere dai toni soffici e armoniosi.

Lampada da terra a luce diffusa dimerabile. Montatura in metallo nichelato. Diffusore in vetro soffiato bianco. Cavo di alimentazione, dimmer e spina neri. Spina europea due poli.

Family of lamps, which includes the floor and table version, re-edited by the FontanaArte historical archive. With well-balanced proportions and a simple and refined design, these lamps create atmospheres with soft and harmonious tones.

Dimmable floor lamp providing diffused light Nickel-plated metal fitting. White blown glass diffuser. Black power cable, dimmer and plug. Two-pin European plug.

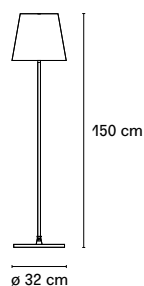

Codice Code	Materiale Material	Colore Colour	Sorgente luminosa Light source	Dimmer Dimmer	Prezzo no IVA Price VAT excluded
F324725150KBNE	Vetro, Metallo Glass, Metal	Nichel, Bianco Nickel, White	1x max 150W E27		762,00 €



VETRO SOFFIATO  
BLOWN GLASS



CE ENEC Classe J  
IP20

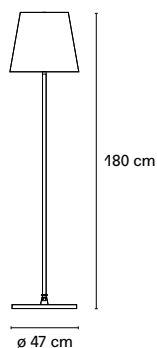

Codice Code	Materiale Material	Colore Colour	Sorgente luminosa Light source	Dimmer Dimmer	Prezzo no IVA Price VAT excluded
F324730150KBNE	Vetro, Metallo Glass, Metal	Nichel, Bianco Nickel, White	4x max 46W E27* + 1x max 100W E27**	* **	1.475,00 €



VETRO SOFFIATO  
BLOWN GLASS

Doppia accensione  
Double light controls

CE ENEC Classe J  
IP20





# BIANCA

Matti Klenell, 2015



Bianca è una famiglia di lampade la cui decorazione sulla superficie del diffusore è caratterizzata da una serie ordinata di solchi poco profondi e delicati incisi nel vetro bianco, che creano un effetto che ricorda piccole impronte sulla neve fresca. Soffiati a bocca e immersi in acido per ottenere il caratteristico "effetto seta" tipico della vetreria pregiata, i diffusori Bianca sono disponibili in tre diametri diversi per completare tutte le tipologie di lampade appartenenti alla famiglia.

Lampada da terra a luce diffusa e dimmerabile con interruttore scorrevole. Diffusore in vetro soffiato bianco latte con finitura satinata. Struttura in metallo verniciato. Cavo di alimentazione, dimmer e spina trasparenti. Spina europea a due poli.

Bianca is a family of luminaires with the decoration on the diffuser surface features an orderly series of shallow delicate grooves etched into the white glass, yielding an effect resembling small footprints on fresh snow. Mouth blown and dipped in acid to obtain the distinctive 'silk effect' typical of fine glassware, Bianca diffusers are available in three different diameters to complete all types of luminaires belonging to the family.

Floor lamp with diffused and dimmable light with sliding switch. Milk-white diffuser made of blown glass with satin-finish. Painted metal frame. Transparent power cable, dimmer and plug. European two-pole plug.

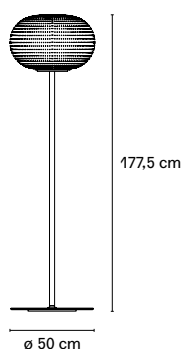

Codice Code	Materiale Material	Colore Colour	Sorgente luminosa Light source	Dimmer Dimmer	Prezzo no IVA Price VAT excluded
F430930150BINE	Vetro, Metallo Glass, Metal	○ Bianco White	1x max 116W E27	✓	902,00 €





# CHESHIRE

GamFratesi, 2013



Riflette l'impronta nordica dello studio nella semplicità dell'estetica e della funzionalità. La calotta è di policarbonato opalino per favorire l'emissione diffusa; colorato per diffondere la luce verso il basso nella versione da tavolo e da terra oppure opalina nella versione sospesa.

Lampada da terra a luce diretta non dimmerabile. Struttura in metallo verniciato. Diffusore superiore in policarbonato verniciato; diffusore inferiore in policarbonato opalino. Cavo di alimentazione, spina e interruttore trasparenti. Spina europea a due poli.

It reflects the firm's Nordic imprint in the simplicity of aesthetics and functionality. The dome is made of opal polycarbonate to encourage diffuse emission; coloured to diffuse the light downwards in the table and floor versions or opal in the suspended version.

Floor lamp with direct light not dimmable. Painted metal frame. Top diffuser made of painted polycarbonate; bottom diffuser made of opaline polycarbonate. Transparent power cable, plug and switch. European two-pole plug.

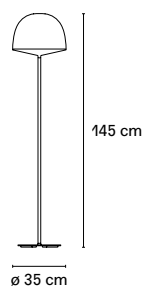

Codice Code	Materiale Material	Colore Colour	Sorgente luminosa Light source	Dimmer Dimmer	Prezzo no IVA Price VAT excluded
F425225350BINE	Polimero, Metallo Polymer, Metal	○ Bianco White	3x max 23W E27	⊗	516,00 €
F425225350NENE	Polimero, Metallo Polymer, Metal	● Nero Black	3x max 23W E27	⊗	516,00 €





# EQUATORE



*Gabriele e Oscar Buratti, 2017*

Reinterpretazione in chiave contemporanea delle classiche lampade con paralume in vetro. Se nelle tradizionali abat-jour il diffusore alloggia al suo interno la sorgente luminosa, in questa famiglia di lampade il diffusore è paradossalmente e suggestivamente vuoto e l'effetto luminoso è prodotto da due dischi luminosi all'interno di una fascia metallica centrale, visibile sul paralume e che richiama la linea dell'equatore.

Lampada da terra a luce diffusa e dimmerabile generata da led inseriti in due dischi di policarbonato sovrapposti. Il disco inferiore dirige la luce verso il basso, quello superiore illumina la calotta di vetro. Cornice opaca verniciata. Diffusore in vetro trasparente e colorato. Cavo di alimentazione, dimmer e spina neri. Alimentatore plug-in con spine intercambiabili (UK - USA - UE).

A contemporary reinterpretation of the classic lamp with glass shade. While in traditional abat-jours the diffuser houses the light source inside, in this family of lamps the diffuser is paradoxically and suggestively empty and the luminous effect is produced by two luminous discs within a central metal band, visible on the lampshade and recalling the line of the equator.

Floor lamp with diffused and dimmable light generated by led inserted into two overlapping polycarbonate discs. The bottom disc directs the light output downward, the upper one illuminates the glass cap. Painted metal frame. Diffuser made of transparent and coloured glass. Black power cable, dimmer and plug. Plug-in power supply with interchangeable plugs (UK - USA - UE).



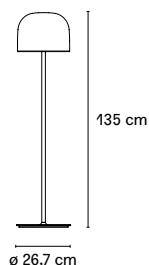







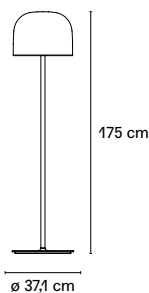

Codice Code	Materiale Material	Colore Colour	Sorgente luminosa Light source	Dimmer Dimmer	Prezzo no IVA Price VAT excluded
F439220550CRWL	Vetro, Metallo Galvanizzato Glass, Galvanized Metal	 Cromo Chrome	LED 25W (2700K, CRI>90, 2900Lm)		1.262,00 €
F439220550NEWL	Vetro, Metallo Galvanizzato Glass, Galvanized Metal	 Nero lucido Glossy black	LED 25W (2700K, CRI>90, 2900Lm)		1.262,00 €
F439220150OOWL	Vetro, Metallo Glass, Metal	 Oro opaco Matt gold	LED 25W (2700K, CRI>90, 2900Lm)		1.131,00 €
F439220550RSWL	Vetro, Metallo Galvanizzato Glass, Galvanized Metal	 Rame lucido Glossy copper	LED 25W (2700K, CRI>90, 2900Lm)		1.262,00 €



Possibilità di acquisto con tecnologia Dali o Casambi su richiesta  
Dali or Casambi technology on request



Codice Code	Materiale Material	Colore Colour	Sorgente luminosa Light source	Dimmer Dimmer	Prezzo no IVA Price VAT excluded
F439225550CRWL	Vetro, Metallo Galvanizzato Glass, Galvanized Metal	 Cromo Chrome	LED 40W (2700K, CRI>90, 4500Lm)		1.893,00 €
F439225550NEWL	Vetro, Metallo Galvanizzato Glass, Galvanized Metal	 Nero lucido Glossy black	LED 40W (2700K, CRI>90, 4500Lm)		1.893,00 €
F439225150OOWL	Vetro, Metallo Glass, Metal	 Oro opaco Matt gold	LED 40W (2700K, CRI>90, 4500Lm)		1.718,00 €
F439225550RSWL	Vetro, Metallo Galvanizzato Glass, Galvanized Metal	 Rame lucido Glossy copper	LED 40W (2700K, CRI>90, 4500Lm)		1.893,00 €



Possibilità di acquisto con tecnologia Dali o Casambi su richiesta  
Dali or Casambi technology on request

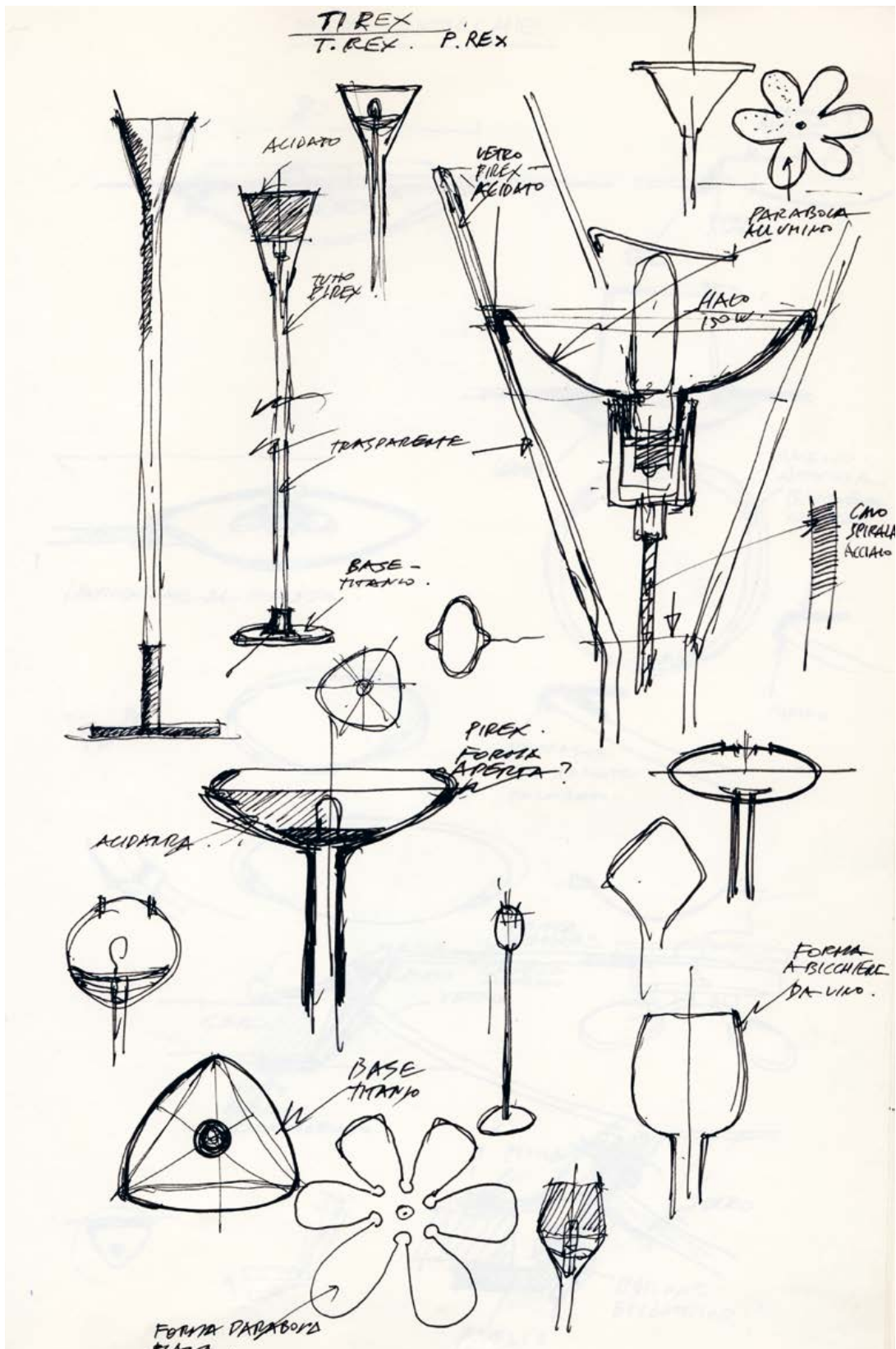



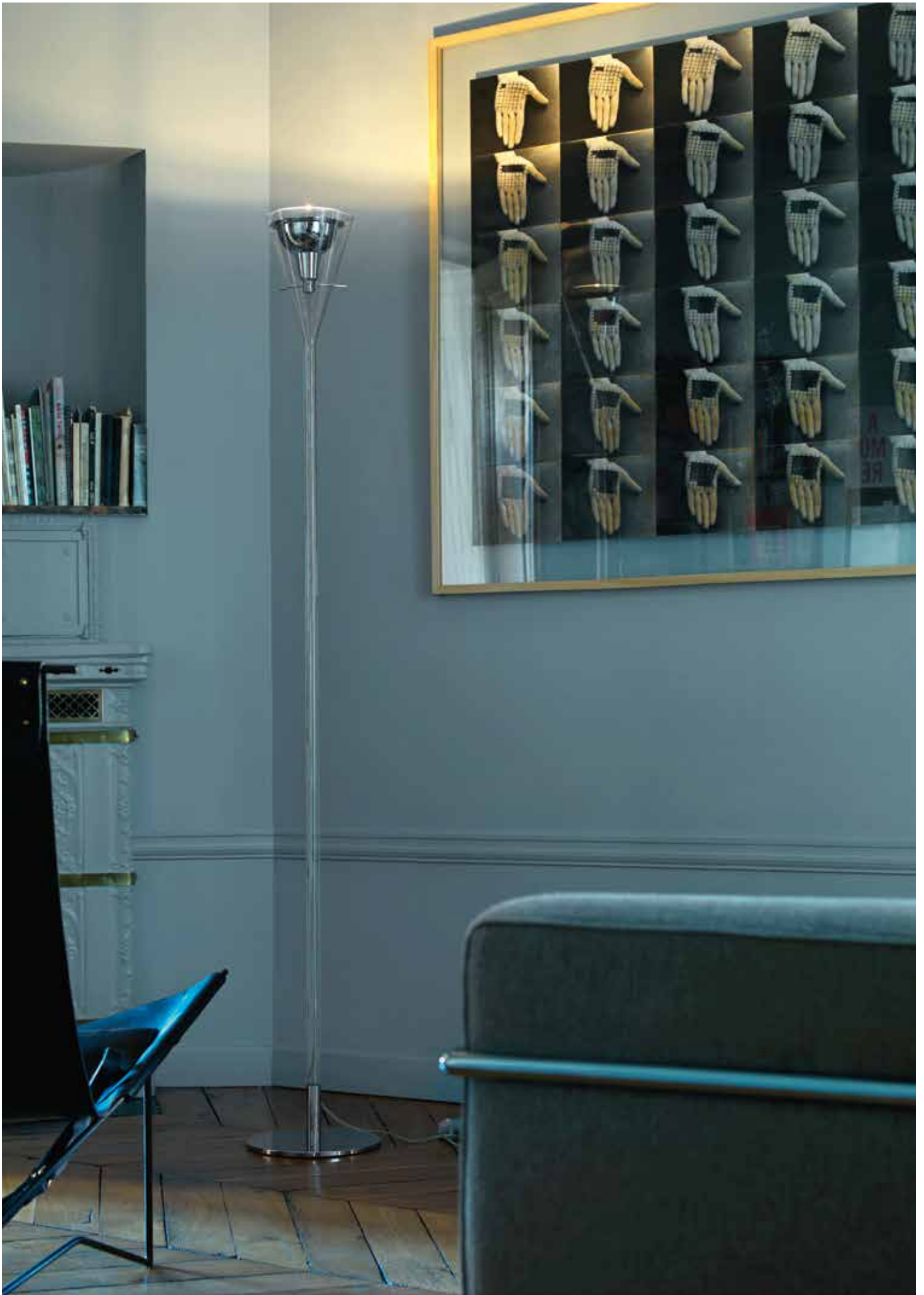

# FLÛTE

Franco Raggi, 1999



Un cono di vetro alloggia il riflettore in alluminio cromato, sorretto da tre aste sottili in metallo. Equilibrio e leggerezza per questa famiglia di lampade disponibili nella versione da terra e parete per una emissione di luce indiretta e a sospensione, per una emissione di luce puntuale e diretta.

Lampada da terra a luce indiretta dimmerabile a pavimento con cursore a scorrimento. Stelo in vetro borosilicato trasparente. Riflettore in alluminio cromato lucido. Base e supporto riflettore in metallo cromato. Cavo di alimentazione, dimmer e spina trasparenti. Spina di tipo shuko, adattatore non incluso.

A glass cone holds the chromed aluminum reflector, supported by three slender metal rods. Equilibrium and lightness for this family of lamps available in floor and wall versions, for indirect light emission, and in a hanging version, for direct focused light.

Floor lamp indirect and dimmable light with sliding switch. Transparent borosilicate glass stem. Reflector made of glossy chromed aluminium. Base and reflector support made of chromed metal. Transparent power cable, dimmer and plug. Schuko plug, adapter not included.

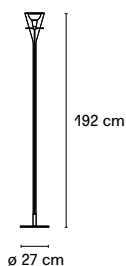

Codice Code	Materiale Material	Colore Colour	Sorgente luminosa Light source	Dimmer Dimmer	Prezzo no IVA Price VAT excluded
F330025150TCNE	Vetro, Metallo Glass, Metal	Trasparente, Cromo Transparent, Chrome	1x max 205W E27	☑	1.189,00 €

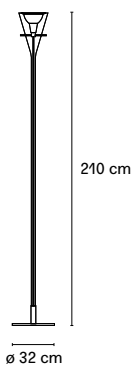

Codice Code	Materiale Material	Colore Colour	Sorgente luminosa Light source	Dimmer Dimmer	Prezzo no IVA Price VAT excluded
F330030150TCNE	Vetro, Metallo Glass, Metal	Trasparente, Cromo Transparent, Chrome	1x max 230W R7s/115	☑	2.295,00 €







# LUMEN

*Historical Archive, 1954*

Un cono di vetro alloggia il riflettore in alluminio sorretto da una crociera verniciati bianchi.

Lampada da terra a doppia accensione. Montatura in metallo verniciato. Diffusore in vetro soffiato satinato. Lampada dimmerabile parzialmente a pavimento con interruttore a scorrimento. Cavo di alimentazione, dimmer e spina neri. Spina europea due poli.

A glass cone houses the aluminium reflector supported by a white painted cross.

Floor lamp with dual switching. Painted metal frame. Diffuser made of blown glass with satin-finish. Partially dimmable light with sliding switch. Black power cable, dimmer and plug. European two-pole plug.

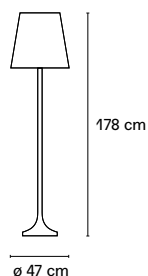

Codice Code	Materiale Material	Colore Colour	Sorgente luminosa Light source	Dimmer Dimmer	Prezzo no IVA Price VAT excluded
F248225150BINE	Vetro, Metallo Glass, Metal	○ Bianco White	4x max 30W E27* + 1x max 80W E27**	☑ * ☒ **	1.623,00 €



Doppia accensione  
Double light controls



# S. A. LUIGI FONTANA & C.

SEDE CENTRALE: MILANO - VIA PRIVATA G. BUGATTI, 8 - TELEFONI 30-062 - 30-074 - 32-437

SALA DI ESPOSIZIONE E VENDITA: VIA MONTENAPOLEONE, 21 - TELEFONO 75-089

*Fontana Arte*

CON LA DIREZIONE ARTISTICA DELL'ARCH. GIO PONTI E DI PIETRO CHIESA

*Sede centrale in Milano via privata Bugatti, 8 Telefoni 32-437-30-074-30-062*

*Negozio in via del Montenapoleone N. 21 - Milano - Telefono A 75089*

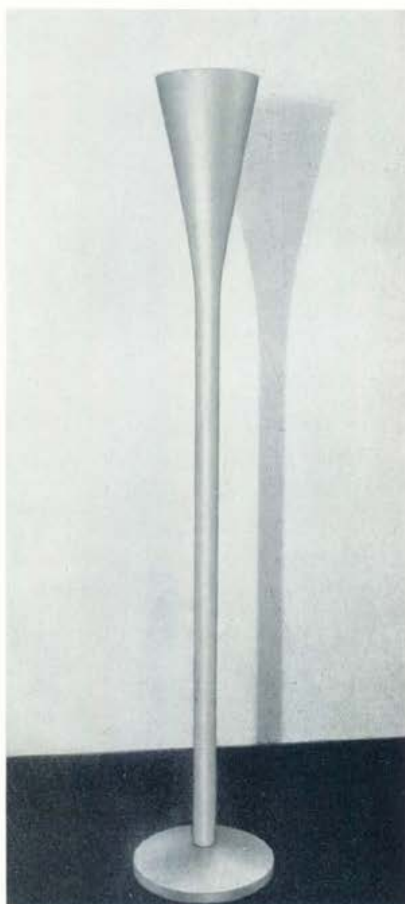

LAMPADRE - RIVESTIMENTI - MOBILI - VETRATE  
TUTTE LE LAVORAZIONI MOBILI DEL VETRO E DEL CRISTALLO



# LUMINATOR

Pietro Chiesa, 1933

Prima lampada da terra ad illuminazione indiretta, Luminator è composta da un sottile fusto metallico che si apre a cono e al cui interno si trova la sorgente luminosa. Unico elemento che poggia su una base circolare, è una lampada di un rigore e una purezza quasi astratte.

Lampada da terra a luce indiretta dimmerabile a pavimento a pulsante. Montatura in metallo verniciato. Cavo di alimentazione, dimmer e spina neri. Alimentatore su spina con plug intercambiabili (UK - USA - UE).

The first indirect light floor lamp, Luminator is composed of a thin metal shaft that opens into a cone, inside which is the light source. A single element resting on a circular base, it is a lamp of an almost abstract rigor and purity.

Floor lamp with indirect light and dimmable by switch button. Painted metal frame. Black power cable, dimmer and plug. Plug-in power supply with interchangeable plugs (UK - USA - UE).

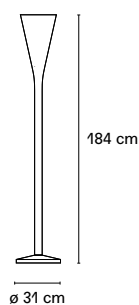

Codice Code	Materiale Material	Colore Colour	Sorgente luminosa Light source	Dimmer Dimmer	Prezzo no IVA Price VAT excluded
F005630200NSWL	Metallo Metal	● Nichel Nickel	LED 30W (3000K, CRI>80, 3000Lm)	✓	2.049,00 €
F005630210BIWL	Metallo Verniciato Painted Metal	○ Bianco White	LED 30W (3000K, CRI>80, 3000Lm)	✓	2.049,00 €

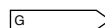

Su richiesta con  
tecnologia Casambi  
Casambi technology  
on request



# MERIDIANO

Gabriele e Oscar Buratti, 2020





Passando tra layer opalini, colorati e trasparenti, enfatizzata dalle curvature ricercate e dalla magia dei vetri soffiati, la luce è libera di creare effetti, disegni ed atmosfere sorprendenti ed affascinanti. In Meridiano, il tubo cilindrico verticale contiene e diffonde la luce nella capsula di vetro trasparente, che ne definisce la ricercata forma ovoidale.

Lampada da terra a luce diffusa dimmerabile. Stelo e base in metallo galvanizzato. Diffusore esterno in vetro soffiato. Diffusore interno in vetro pirex verniciato internamente. Cavo di alimentazione, dimmer e spina neri. Alimentatore su spina con plug intercambiabili (UK - USA - UE).

Passing through opal, coloured and transparent layers, emphasised by the refined curves and magic of blown glass, light is free to create surprising and fascinating effects, patterns and atmospheres. In Meridiano, the vertical cylindrical tube contains and diffuses light in the transparent glass capsule, which defines its refined ovoid shape.

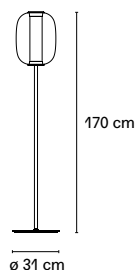
Floor lamp providing diffused dimmable light. Galvanised metal stem and base. Blown glass outer diffuser. Internally painted pyrex glass diffuser. Black power cable, dimmer and plug. Power supply on plug with interchangeable plugs (UK - USA - EU).



Codice Code	Materiale Material	Colore Colour	Sorgente luminosa Light source	Dimmer Dimmer	Prezzo no IVA Price VAT excluded
F44170550NFWL	Vetro, Metallo Galvanizzato Glass, Galvanized Metal	 Nero, Fumè Black, Grey fumè	LED 25W (2700K, CRI>90, 2900Lm) + LED 8W (2700K, 1180Lm)		1.803,00 €



Su richiesta con tecnologia Casambi  
Casambi technology on request





# OORT

Jacopo Roda, 2022



Come la nube di OORT è l'origine di milioni di nuclei di comete che con la loro scia illuminano il Firmamento, così il sistema di lampade componibile dalla quale prende il nome è l'origine di una serie infinita di soluzioni luminose.

La versione terra-cielo è proposta con un contrappeso a terra e un aggancio nickel nero a soffitto che ne garantiscono la perfetta stabilità. Cavo di alimentazione, dimmer e spina neri. Alimentatore su spina con plug intercambiabili (UK - USA - UE). La lampada mantiene memoria dell'ultima impostazione di dimmerazione.

Just as the OORT cloud is the origin of millions of comet nuclei that illuminate the Firmament with their wake, so the modular lamp system from which it takes its name is the origin of an endless series of lighting solutions.

The floor-to-ceiling version is offered with a ground counterweight and a black nickel ceiling hook that guarantee perfect stability. Black power cable, dimmer and plug. Power supply on plug with interchangeable plugs (UK - USA - EU). The lamp retains memory of the last dimming setting.

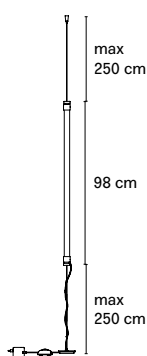

Codice Code	Materiale Material	Colore Colour	Sorgente luminosa Light source	Dimmer Dimmer	Prezzo no IVA Price VAT excluded
OORT00101	Vetro, Metallo Galvanizzato Glass, Galvanized Metal	● Nichel nero Nickel black	LED 18W (2700K, 1700Lm)	⊙	541,00 €



Su richiesta tecnologia  
Casambi e 3000K  
Casambi technology and  
3000K on request

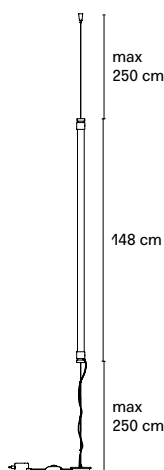

Codice Code	Materiale Material	Colore Colour	Sorgente luminosa Light source	Dimmer Dimmer	Prezzo no IVA Price VAT excluded
OORT00102	Vetro, Metallo Galvanizzato Glass, Galvanized Metal	● Nichel nero Nickel black	LED 28W (2700K, 2660Lm)	⊙	607,00 €



Su richiesta tecnologia  
Casambi e 3000K  
Casambi technology and  
3000K on request





# PAROLA

Gae Aulenti e Piero Castiglioni, 1980

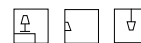

Nella lampada Parola, convivono in un solo oggetto tre diverse tipologie e lavorazioni del vetro: soffiato, borosilicato tornito e in lastra molato naturale. Rappresenta un modello esemplare di integrazione tecnica fra artigianato e industria.



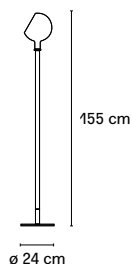

Lampada da terra a luce diffusa dimmerabile con interruttore a pavimento a scorrimento. Montatura in vetro borosilicato con attacco base in metallo cromato. Diffusore in vetro soffiato lucido colorato in pasta. Base in vetro trasparente molato. Cavo di alimentazione in tessuto tigrato, dimmer e spina neri. Spina di tipo shuko e adattatore non incluso.

In the Parola lamp, three different types and processes of glass coexist in a single object: blown, turned borosilicate and natural ground sheet. It represents an exemplary model of technical integration between craftsmanship and industry.

Floor lamp with diffused light dimmable with sliding switch. Borosilicate glass frame with base connection in chromed metal. Tinted paste blown glass diffuser, glossy. Transparent bevelled glass base. Braided fabric cable, black dimmer and plug. Schuko plug, and adapter not included.



## PAROLA



Codice Code	Materiale Material	Colore Colour	Sorgente luminosa Light source	Dimmer Dimmer	Prezzo no IVA Price VAT excluded
F265925100AMNE	Vetro Glass	 Ambra Amber	1x max 60W E14		861,00 €
F265925100BINE	Vetro Glass	 Bianco White	1x max 60W E14		861,00 €

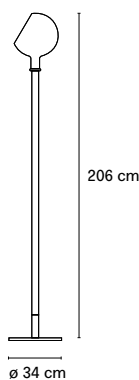

CE ENEC IP20



## PAROLONA

Codice Code	Materiale Material	Colore Colour	Sorgente luminosa Light source	Dimmer Dimmer	Prezzo no IVA Price VAT excluded
F275130150BINE	Vetro Glass	 Bianco White	1x max 60W E14		1.066,00 €



CE ENEC IP20







# PIRELLONE

Gio Ponti, 1967



Pirellone e Pirellina sono da più di 40 anni dei classici intramontabili dell'illuminazione. Una coppia di lastre di vetro curvate e trattenute in posizione da due elementi metallici, alla base e all'estremità superiore: una struttura semplice, ottenuta grazie all'utilizzo di un vetro particolarmente resistente agli urti.

Lampada da terra a luce diffusa/indiretta e parzialmente dimmerabile con interruttore a scorrimento. Il dimmer consente di accendere/spengere le sorgenti luminose all'interno del diffusore e dimmerare la lampadina superiore. Montatura in metallo nichelato. Diffusore in vetro pressato curvato. Cavo di alimentazione, dimmer e spina neri. Spina Shuko, adattatore non incluso.

Pirellone and Pirellina have been timeless lighting classics for more than 40 years. A pair of curved glass panes held in place by two metal elements at the base and top: a simple structure, achieved through the use of particularly impact-resistant glass.

Floor lamp with diffused/indirect and partially dimmable light with sliding switch. The dimmer allows to switch on/off the light sources inside the diffuser, and it provides dimming for the upper bulb. Frame made of nickel-plated metal. Diffuser made of curved pressed glass. Black power cable, dimmer and plug. Shuko plug, adapter not included.

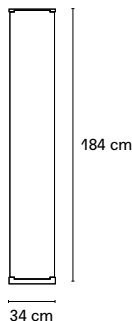

Codice Code	Materiale Material	Colore Colour	Sorgente luminosa Light source	Dimmer Dimmer	Prezzo no IVA Price VAT excluded
F275930150KBNE	Vetro, Metallo Glass, Metal	Nichel, Bianco Nickel, White	10x max 4W G9*  + 1x max 200W R75**	⊗ *  ⊙ **	2.295,00 €



Doppia accensione  
Double light controls





# PRIMA SIGNORA

*Daniela Puppa, 1992*



Un treppiede cromato la cui sommità inaspettatamente si infila all'interno di una preziosa sfera in vetro soffiato bianco. Linee essenziali, accostate in modo inedito, per un effetto d'insieme molto equilibrato.

Lampada da terra a luce diffusa dimmerabile a pavimento con interruttore a pavimento a scorrimento. Montatura in metallo cromato. Diffusore in vetro soffiato opalino. Cavo di alimentazione, dimmer e spina trasparenti. Spina europea due poli.

A magnificent globe in white blown glass crowns the chrome-plated tripod. The surprising arrangement of these understated lines produces a very well-balanced result.

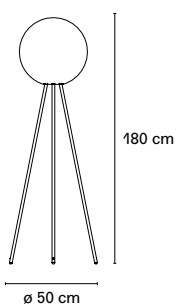
Floor lamp with diffused light dimmable with sliding switch. Chromed metal frame. Opaline blown glass diffuser. Transparent power cable, dimmer and plug. European two-pole plug.



Codice Code	Materiale Material	Colore Colour	Sorgente luminosa Light source	Dimmer Dimmer	Prezzo no IVA Price VAT excluded
F289130150CBNE	Vetro, Metallo Glass, Metal	 Cromo, Bianco Chrome, White	1x max 205W E27		1.107,00 €





# VERTIGO

Marco Acerbis, 2005



Il gioco di spigoli e facce che caratterizza questa lampada da terra a luce indiretta deriva dall'applicazione inedita di un sottile foglio di alluminio piegato. La struttura è montata su una base in acciaio e può essere ruotata fino a 320°.

Lampada da terra a luce indiretta dimmerabile a pavimento a pulsante. Montatura in metallo cromato. Cavo di alimentazione, dimmer e spina neri. Alimentatore su spina con plug intercambiabili (UK - USA - UE).

This indirect light floor lamp with its distinctive sharp corners and edges is the result of folding a fine sheet of aluminum. The structure is mounted on a steel base and can be rotated 320°.

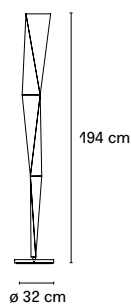
Floor lamp with indirect light and dimmable by switch button. Painted metal frame. Black power cable, dimmer and plug. Plug-in power supply with interchangeable plugs (UK - USA - UE).



Codice Code	Materiale Material	Colore Colour	Sorgente luminosa Light source	Dimmer Dimmer	Prezzo no IVA Price VAT excluded
F553130240CRWL	Metallo Metal	 Acciaio Steel	LED 30W (3000K, CRI>80, 3000Lm)		1.869,00 €

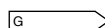

Su richiesta  
tecnologia Casambi  
Casambi technology  
on request







# YUMI

Shigeru Ban, 2011

Yumi in giapponese significa arco, una forma elementare oggi reinterpretata da Shigeru Ban per FontanaArte. Una sintesi assoluta destinata a diventare un nuovo classico universale. Yumi è delicatezza e forza insieme: un segno essenziale che incontra una struttura resistente e leggera.

Lampada da terra dimerabile a luce diretta. Montatura e base in metallo verniciato. Cavo di alimentazione, dimmer e spina neri. Alimentatore su spina con plug intercambiabili (UK - USA - UE).

Yumi means bow in Japanese. Today, this simple shape is re-interpreted by Shigeru Ban for FontanaArte. Its absolute harmony is destined to turn into a new universal classic. Yumi is both delicate and strong: an essential sign that meets a resistant and light structure.

Floor lamp with direct and dimmable light. Painted metal frame and base. Black power cable, dimmer and plug. Plug-in power supply with interchangeable plugs (UK - USA - UE).

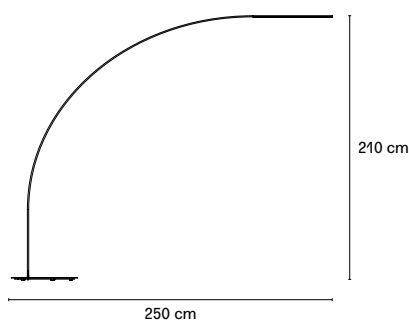

Codice Code	Materiale Material	Colore Colour	Sorgente luminosa Light source	Dimmer Dimmer	Prezzo no IVA Price VAT excluded
F414330200BIWL	Metallo Metal	○ Bianco White	LED 20W (2700K, CRI>90, 2000Lm)	✓	1.787,00 €
F414330200NEWL	Metallo Metal	● Nero Black	LED 20W (2700K, CRI>90, 2000Lm)	✓	1.787,00 €



Su richiesta  
tecnologia Casambi  
Casambi technology  
on request

## LAMPADE DA PARETE / WALL LAMPS

BIANCA	p. 126
BONNET	p. 128
BRUCO	p. 130
FALENA	p. 132
FLEX	p. 134
FONTANELLA	p. 137
FRENESI	p. 139
IO	p. 142
LUNAIRE	p. 145
NASKA	p. 148
NOBI	p. 151
PALLINA	p. 153
PAROLA	p. 155
RIGA	p. 157
SCINTILLA	p. 159
SILLABA	p. 161
SOLE	p. 163
TROPICO	p. 165



# BIANCA

Matti Klenell, 2015



Bianca è una famiglia di lampade la cui decorazione sulla superficie del diffusore è caratterizzata da una serie ordinata di solchi poco profondi e delicati incisi nel vetro bianco, che creano un effetto che ricorda piccole impronte sulla neve fresca. Soffiati a bocca e immersi in acido per ottenere il caratteristico "effetto seta" tipico della vetreria pregiata, i diffusori Bianca sono disponibili in tre diametri diversi per completare tutte le tipologie di lampade appartenenti alla famiglia.

Lampada da parete/plafone a luce diffusa dimmerabile. Diffusore in vetro incamiciato di colore bianco latte, soffiato a fermo e satinato. Montatura in metallo verniciato.

Bianca is a family of luminaires with the decoration on the diffuser surface features an orderly series of shallow delicate grooves etched into the white glass, yielding an effect resembling small footprints on fresh snow. Mouth blown and dipped in acid to obtain the distinctive 'silk effect' typical of fine glassware, Bianca diffusers are available in three different diameters to complete all types of luminaires belonging to the family.

Wall/ceiling lamp providing diffused dimmable light. Satin-blown, milk-white layered glass diffuser. Painted metal fitting.

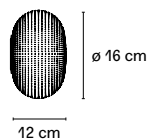

Codice Code	Materiale Material	Colore Colour	Sorgente luminosa Light source	Dimmerabile Dimmable	Prezzo no IVA Price VAT excluded
F432860150BINE	Vetro, Metallo Glass, Metal	○ Bianco White	1x max 30W G9	☑	242,00 €

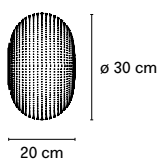

Codice Code	Materiale Material	Colore Colour	Sorgente luminosa Light source	Dimmerabile Dimmable	Prezzo no IVA Price VAT excluded
F432865150BINE	Vetro, Metallo Glass, Metal	○ Bianco White	1x max 46W E27	☑	328,00 €

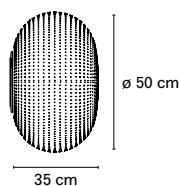

Codice Code	Materiale Material	Colore Colour	Sorgente luminosa Light source	Dimmerabile Dimmable	Prezzo no IVA Price VAT excluded
F432870150BINE	Vetro, Metallo Glass, Metal	○ Bianco White	1x max 116W E27	☑	598,00 €







# BONNET

Odo Fioravanti, 2014

Dalla forma elegante e sinuosa, Bonnet è un apparecchio di illuminazione a parete che reinterpreta il concetto di illuminazione indiretta. La parte superiore del corpo accoglie e nasconde una piccola ma potentissima sorgente a Led, il cui fascio luminoso si direziona prevalentemente verso la parete superiore ed il soffitto. Una lente recupera la luce parassita, normalmente persa, indirizzandola verso il basso; in questo modo la lampada, oltre ad illuminare sé stessa, produce un'emissione luminosa verso il basso.

Lampada a parete a luce indiretta dimmerabile. Montatura in alluminio pressofuso verniciato.

With its elegant sinuous shape, Bonnet is the new LED lamp that reworks the concept of indirect lighting. The top part conceals a small yet very powerful LED source whose ray of light is mainly directed upwards onto the wall and ceiling. The designer also wanted to play with the parasite light that is normally lost, recuperating it with a lens and directing it downwards. In this way, Bonnet not only lights itself up but also produces a downwards glow.

Wall lamp with indirect light dimmable. Frame made of painted die-cast aluminium.

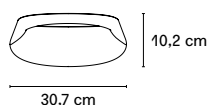

Codice Code	Materiale Material	Colore Colour	Sorgente luminosa Light source	Dimmerabile Dimmable	Prezzo no IVA Price VAT excluded
F443245200BILE	Metallo Metal	○ Bianco White	LED 18W (2700K, CRI>80, 2300Lm)	☑ Trailing edge Trailing edge	270,00 €





# BRUCO

*Vico Magistretti, 2003*

Disegnata per FontanaArte nel 2003 dal designer, architetto e urbanista Vico Magistretti, questa piccola lampada da parete è composta da due sfere in vetro soffiato. Per forma e dimensioni, è perfetta in qualsiasi spazio e contesto domestico.

Lampada da parete a luce diffusa dimmerabile. Montatura in metallo nichelato. Diffusori in vetro soffiato satinato bianco.

Designed for FontanaArte in 2003 by the designer, architect and urban planner Vico Magistretti, this small wall lamp is made up of two blown glass spheres. In shape and size, it is perfect in any space and domestic context.

Wall lamp with diffused and dimmable light. Nickel-plated metal frame. Diffuser made of white blown glass with satin-finish.

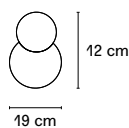

Codice Code	Materiale Material	Colore Colour	Sorgente luminosa Light source	Dimmerabile Dimmable	Prezzo no IVA Price VAT excluded
F353845100BINE	Vetro Glass	○ Bianco White	1x max 46W E14	✓	238,00 €





# FALENA

Alvaro Siza, 1994



Leggerezza ed eleganza in questa famiglia di lampade disegnata da Alvaro Siza e disponibili nella versione da tavolo e parete. Corpo e alette diffusori orientabili per una gestione totale della luce.

Lampada da parete con luce direzionabile non dimmerabile. Montatura in metallo cromato con corpo orientabile. Alette diffusori, orientabili, in alluminio anodizzato. Schermo di protezione lampadina in vetro sabbato. Il collegamento elettrico fra lo stelo e il supporto a parete avviene tramite jack. Cavo di alimentazione, interruttore e spina neri. Alimentatore su spina europea a due poli.

Lightness and elegance for this family of lamps designed by Alvaro Siza and available table and wall versions. Adjustable body and diffuser wings for complete management of light.

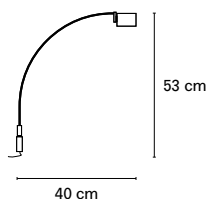
Wall lamp with directional light not dimmable. Frame made of chromed metal with adjustable body. Pivoting diffuser fins made of anodized aluminium. Protection screen of the bulb made of sandblasted glass. Electrical connection between base and body through jack. Black power cable, switch and plug. European two-pole plug power supply.



Codice Code	Materiale Material	Colore Colour	Sorgente luminosa Light source	Dimmerabile Dimmable	Prezzo no IVA Price VAT excluded
F301945150CRNE	Vetro, Metallo Glass, Metal	 Cromo Chrome	1x max 50W GY6.35		422,00 €



CE ENEC Classe I  
IP20







# FLEX

*Karim Rashid, 2015*

Flex è una lampada da parete dalla forma iconica e minimale. Crea carattere ed è rigorosa allo stesso tempo, irradia la luce verso l'alto e verso il basso come una sottile superficie galleggiante.

Lampada da parete a luce indiretta dimmerabile con doppia emissione luminosa. Corpo in alluminio pressofuso verniciato opaco. Flex può essere installata in senso orizzontale oppure verticale.

Flex is a wall lamp with an icon minimal shape. It manages to deliver character and formality at one and the same time, radiating light both upwards and downwards like a fine floating surface.

Wall lamp with indirect with double light intensity. Body made of painted die-cast aluminium. Flex can be installed horizontally or vertically.

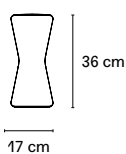

Codice Code	Materiale Material	Colore Colour	Sorgente luminosa Light source	Dimmerabile Dimmable	Prezzo no IVA Price VAT excluded
F449445200BILE	Vetro, Metallo Glass, Metall	○ Bianco White	LED 2x9W (2700K, CRI >80, 2x1280Lm)	✓ TRIAC TRIAC	283,00 €
F449445200NELE	Vetro, Metallo Glass, Metall	● Nero Black	LED 2x9W (2700K, CRI >80, 2x1280Lm)	✓ TRIAC TRIAC	283,00 €





# FONTANELLA

Federico Peri, 2020



Due materiali: metallo e vetro, come nella storica tradizione di FontanaArte. Il metallo funge da corpo mentre il vetro, vero protagonista del progetto, viene sapientemente lavorato da abili artigiani in un processo di fusione fra una porzione di vetro trasparente ed una satinata dalla quale la luce si diffonde. Fontanella è formata dall'unione di due vetri: il tubo interno viene filettato, sabbiato ed infine giuntato con il vetro soffiato a forma di bolla.

Lampada da parete e plafone a luce diffusa dimmerabile. Montatura in metallo galvanizzato. Diffusore in vetro soffiato in borisilicato.

Two materials: metal and glass, in the historical tradition of FontanaArte. The metal acts as the body while the glass, the true protagonist of the project, is skilfully worked by skilled craftsmen in a process of fusion between a portion of transparent glass and a satinised portion from which light diffuses. Fontanella is formed by joining two pieces of glass: the inner tube is threaded, sandblasted and finally joined with the blown glass in the shape of a bubble.

Wall an ceiling lamp with dimmable diffused light. Galvanized metal frame. Borosilicate blown glass diffuser.

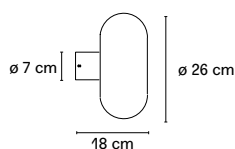

Codice Code	Materiale Material	Colore Colour	Sorgente luminosa Light source	Dimmerabile Dimmable	Prezzo no IVA Price VAT excluded
F447745550NENE	Vetro, Metallo Galvanizzato Glass, Galvanized Metal	● Nero lucido Glossy black	1x max 28W E14	☑	430,00 €
F447745550OTNE	Vetro, Metallo Galvanizzato Glass, Galvanized Metal	● Ottone lucido Glossy Brass	1x max 28W E14	☑	447,00 €



CE IP20

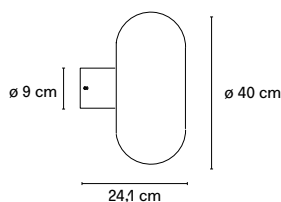

Codice Code	Materiale Material	Colore Colour	Sorgente luminosa Light source	Dimmerabile Dimmable	Prezzo no IVA Price VAT excluded
F447750550NENE	Vetro, Metallo Galvanizzato Glass, Galvanized Metal	● Nero lucido Glossy black	1x max 77W E27	☑	643,00 €
F447750550OTNE	Vetro, Metallo Galvanizzato Glass, Galvanized Metal	● Ottone lucido Glossy Brass	1x max 77W E27	☑	660,00 €



CE IP20

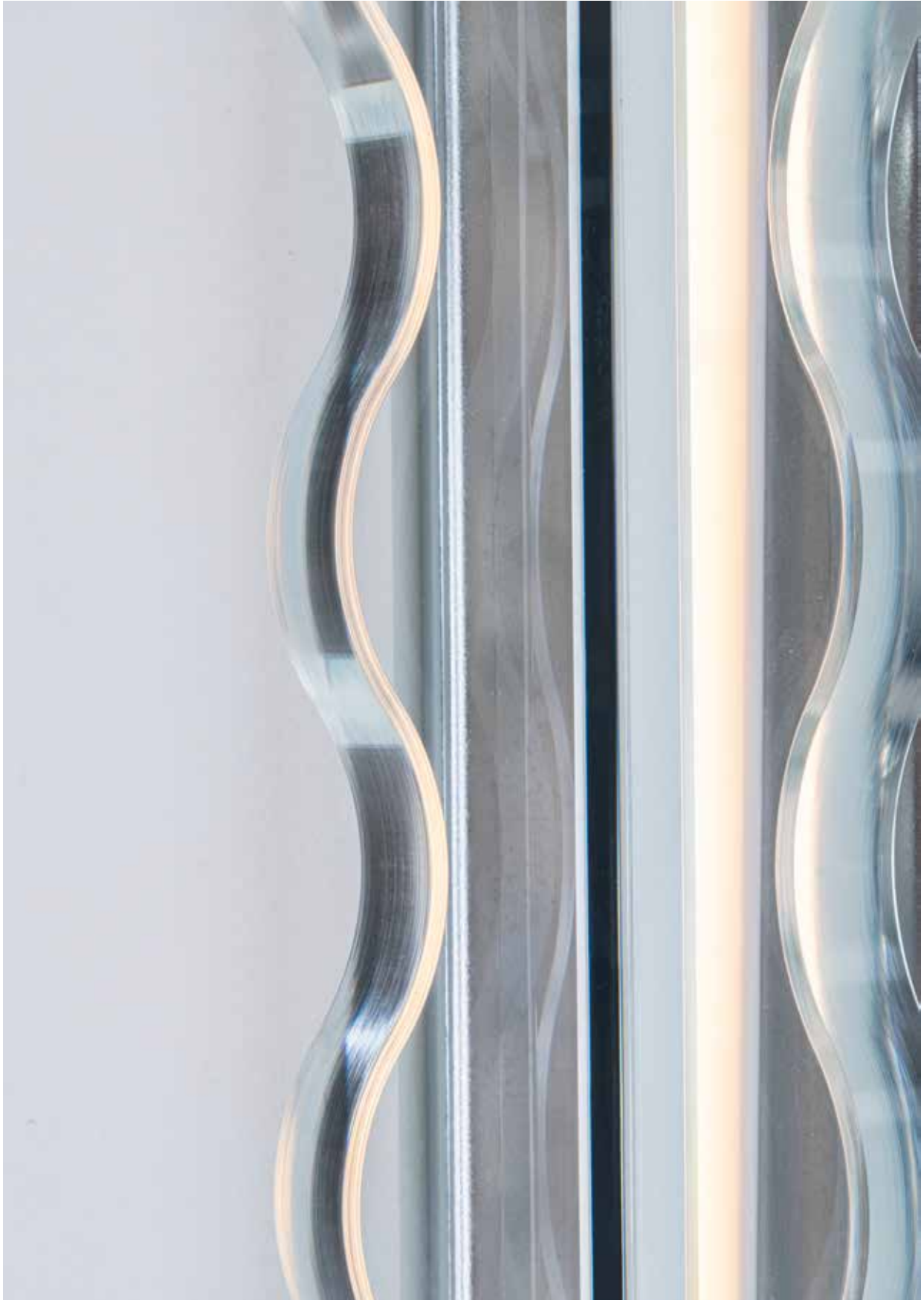





# FRENESI

StudioLucaGuadagnino, 2022

Nasce così Frenesi, che prende il nome dal protagonista del romanzo *Vineland* dello scrittore americano Thomas Pynchon, ispirato all'idea dell'onda, di un'increspatura sensuale, realizzata nel materiale più puro e sostenibile come il vetro, che emana una luce soffusa all'interno della struttura angolare.

Lampada da parete/plafone a luce diffusa dimmerabile. Diffusore in vetro in lastra tagliato, molato e lucidato. Spessore 2 cm in colore extra chiaro. Montatura in metallo cromato galvanizzato.

This is how Frenesi was born, named after the protagonist of the novel *Vineland* by the American writer Thomas Pynchon, inspired by the idea of the wave, a sensual ripple, made of the purest and most sustainable material such as glass, which emanates a soft light within the angular structure.

Dimmable diffused light wall/ceiling lamp. Cut, ground and polished plate glass diffuser. Thickness 2 cm in extra-clear colour. Galvanised chrome metal fitting.

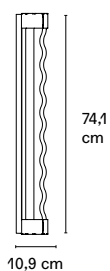

Codice Code	Materiale Material	Colore Colour	Sorgente luminosa Light source	Dimmerabile Dimmable	Prezzo no IVA Price VAT excluded
F446745550TCLE	Vetro, Metallo Glass, Metal	Trasparente, Cromo Transparent, Chrome	LED 2x7W (2700K, CRI>90, 1550Lm)	A taglio di fase Phase cut dimmer	1.721,00 €



CE IP40



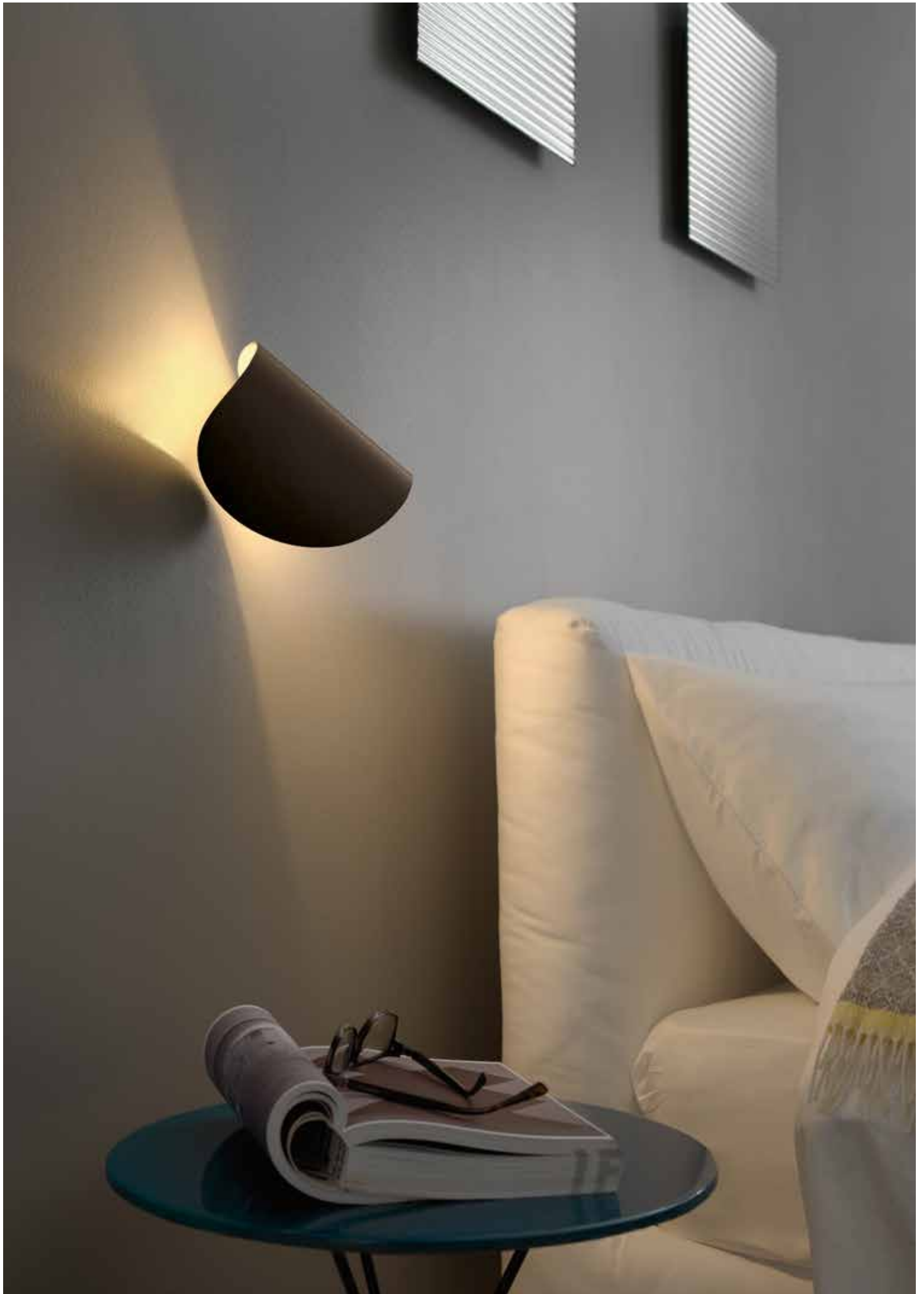

# IO

*Claesson Koivisto Rune, 2015*

Dalla forma di un piccolo disco lunare curvato, IO è una lampada da parete a doppia emissione luminosa Led. IO rimane quasi sospesa, molto vicina alla parete ma mai tanto da toccarla, posizionata ad una distanza tale per cui la luce la accarezza delicatamente con un intimo effetto radente.

Lampada da parete a luce direzionabile. Montatura in metallo verniciato. Grazie alla montatura dal doppio asse di rotazione, la lampada si muove sia sull'asse longitudinale sia lungo quello trasversale, consentendo una gestione totale della luce. Con un movimento Up/Down sul diffusore esterno è possibile inoltre aprire e chiudere il fascio luminoso.

In the shape of a small curved lunar disc, IO is a wall light with dual Led light emission. IO appears almost suspended, very close to the wall but never close enough to touch it; positioned at a distance that allows the light to gently caress the wall with an intimate skimming effect.

Wall lamp with directional light. Painted metal frame. Thanks to its dual-axis rotation frame, it has the distinguishing feature rotating on both longitudinal and transverse axes, for total light management. The Up/Down movement on the external diffuser widens and narrows the ray of light.

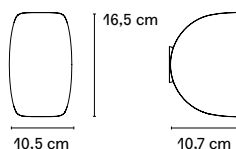

Codice Code	Materiale Material	Colore Colour	Sorgente luminosa Light source	Dimmerabile Dimmerable	Prezzo no IVA Price VAT excluded
F449045200BILE	Metallo Metal	 Bianco White	LED 2x4,5W (2700K, CRI>90, 2x350Lm)	 TRIAC TRIAC	238,00 €
F449045200BSLE	Metallo Metal	 Bronzo Bronze	LED 2x4,5W (2700K, CRI>90, 2x350Lm)	 TRIAC TRIAC	279,00 €
F449045200OOLE	Metallo Metal	 Oro Gold	LED 2x4,5W (2700K, CRI>90, 2x350Lm)	 TRIAC TRIAC	279,00 €
F449045200BLLE	Metallo Metal	 Blu Blue	LED 2x4,5W (2700K, CRI>90, 2x350Lm)	 TRIAC TRIAC	279,00 €
F449045200GSLE	Metallo Metal	 Grigio scuro Dark gray	LED 2x4,5W (2700K, CRI>90, 2x350Lm)	 TRIAC TRIAC	279,00 €
F449045200ROLE	Metallo Metal	 Rosso Red	LED 2x4,5W (2700K, CRI>90, 2x350Lm)	 TRIAC TRIAC	279,00 €









# LUNAIRE

Farrèol Babin, 2013

Lunaire è una lampada da parete che stupisce per il suo effetto luminoso che ricorda il fenomeno di luce prodotto dalle eclissi. Lunaire, grazie al generoso diametro del diffusore, è una lampada adatta all'illuminazione di grandi spazi, siano essi domestici o in ambito contract.

Lampada da parete a luce regolabile tramite il disco centrale posto sul riflettore. Corpo posteriore in polietilene, riflettore e disco centrale in metallo verniciato. Disponibile anche con d. 50 con disco di chiusura fisso.

Lunaire is a wall lamp that impresses with its lighting effect reminiscent of the luminous phenomenon produced by eclipses. Thanks to the generous diameter of the diffuser, Lunaire is a lamp suitable for illuminating large spaces, both domestic and contract.

Wall lamp with adjustable light by means of the central disc on the reflector. Polyethylene back body, painted metal reflector and central disc. Also available with d. 50 with fixed closing disc.

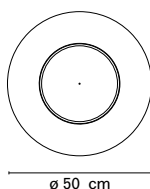

Codice Code	Materiale Material	Colore Colour	Sorgente luminosa Light source	Dimmerabile Dimmable	Prezzo no IVA Price VAT excluded
F424660350BILE	Polimero, Metallo Verniciato Polymer, Painted Metal	○ Bianco White	LED 10W (2700K, CRI 80, 1250Lm)	☑ TRIAC TRIAC	533,00 €

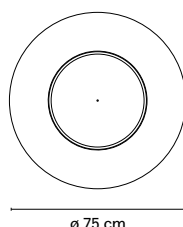

Codice Code	Materiale Material	Colore Colour	Sorgente luminosa Light source	Dimmerabile Dimmable	Prezzo no IVA Price VAT excluded
F424665350BILE	Polimero, Metallo Verniciato Polymer, Painted Metal	○ Bianco White	LED 28,6W (3000K, CRI>80, 3650Lm)	⊗	811,00 €
F424665350NELE	Polimero, Metallo Verniciato Polymer, Painted Metal	◐ Nero, Bianco Black, White	LED 28,6W (3000K, CRI>80, 3650Lm)	⊗	811,00 €
F424665360RNLE	Polimero, Metallo Verniciato Polymer, Painted Metal	◑ Rame, Nero Copper, Black	LED 28,6W (3000K, CRI>80, 3650Lm)	⊗	1.631,00 €
F424665360ONLE	Polimero, Metallo Verniciato Polymer, Painted Metal	◒ Oro, Nero Gold, Black	LED 28,6W (3000K, CRI>80, 3650Lm)	⊗	1.631,00 €





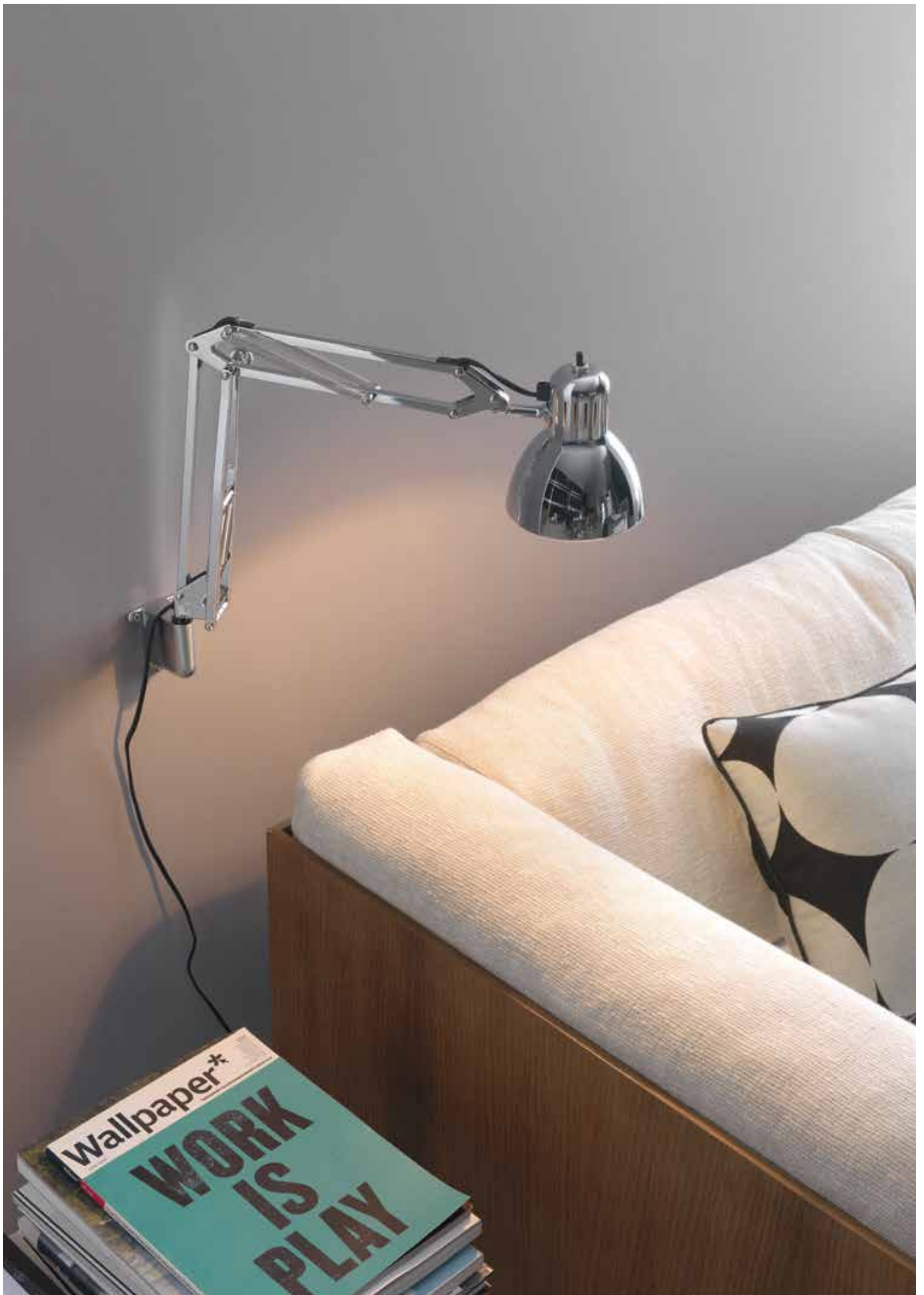



Naska è la lampada da scrivania per eccellenza, l'originale capostipite di tutte le lampade da tavolo con braccio bilanciato a molle. Un oggetto senza tempo, adatto sia per gli spazi domestici che per quelli dedicati al lavoro.

Lampada da parete a luce diretta non dimmerabile. Supporto parete e corpo orientabile in metallo verniciato. Accensione tramite interruttore touch posto sulla testa del diffusore. Cavo e spina neri. Alimentatore su spina con plug intercambiabili (UK, USA, EU).

Naska is the desk lamp par excellence, the original progenitor of all table lamps with a spring-balanced arm. A timeless object, suitable for both home and work spaces.

Wall lamp providing direct non-dimmable light. Wall bracket and swivelling body made of painted metal. Switched on via touch switch on the diffuser head. Black cable and plug. Power supply on plug with interchangeable plugs (UK, USA, EU).

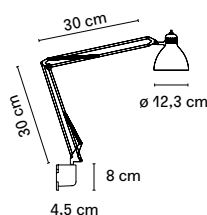

Codice Code	Materiale Material	Colore Colour	Sorgente luminosa Light source	Dimmerabile Dimmerable	Prezzo no IVA Price VAT excluded
F810340200BINE	Metallo Verniciato Painted Metal	○ Bianco White	1x max 46W E27	⊗	352,00 €
F810340240CRNE	Metallo Galvanizzato Galvanized Metal	◐ Cromo Chrome	1x max 46W E27	⊗	402,00 €
F810340200NENE	Metallo Verniciato Painted Metal	● Nero Black	1x max 46W E27	⊗	352,00 €



CE EAC Classe II IP20

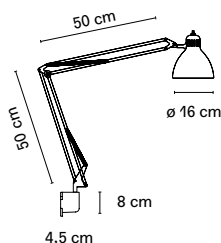

Codice Code	Materiale Material	Colore Colour	Sorgente luminosa Light source	Dimmerabile Dimmerable	Prezzo no IVA Price VAT excluded
F810350200BINE	Metallo Verniciato Painted Metal	○ Bianco White	1x max 46W E27	⊗	361,00 €
F810350240CRNE	Metallo Galvanizzato Galvanized Metal	◐ Cromo Chrome	1x max 46W E27	⊗	418,00 €
F810350200NENE	Metallo Verniciato Painted Metal	● Nero Black	1x max 46W E27	⊗	361,00 €



CE EAC Classe II IP20



# NOBI

*Metis Lighting, 1992*

Innovativo e contemporaneo, Nobi è una lampada che offre la massima funzionalità pur mantenendo una forte presenza estetica. Le sue lenti convesse adiacenti sono tenute in posizione da un sistema di piccole molle fissate alla struttura metallica con due perni, gli stessi su cui è montata anche la sorgente luminosa. Il diffusore può così ruotare su se stesso e orientare il flusso luminoso in diverse direzioni.

Lampada da parete a luce diffusa dimmerabile. Installando il riflettore in dotazione la lampada produce luce diretta/indiretta direzionabile. Montatura in metallo verniciato. Diffusore orientabile in vetro satinato e riflettore in alluminio anodizzato.

Innovative and contemporary, Nobi is a lamp that offers maximum functionality while maintaining a strong aesthetic presence. Its adjacent convex lenses are held in position by a system of small springs fixed to the metal structure with two pivots, the same ones on which the light source is also mounted. The diffuser can thus rotate on itself and direct the light flow in different directions.

Dimmable diffused light wall lamp. By installing the supplied reflector the lamp produces direct/indirect light that can be directed. Painted metal fitting. Adjustable satinised glass diffuser and anodised aluminium reflector.

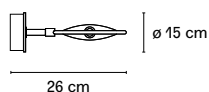

Codice Code	Materiale Material	Colore Colour	Sorgente luminosa Light source	Dimmerabile Dimmable	Prezzo no IVA Price VAT excluded
F302345150BINE	Vetro, Metallo Glass, Metall	○ Bianco White	1x max 120W R7s/80	☑	287,00 €

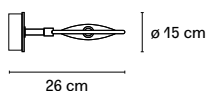

Codice Code	Materiale Material	Colore Colour	Sorgente luminosa Light source	Dimmerabile Dimmable	Prezzo no IVA Price VAT excluded
F302345150CRLE	Vetro, Metallo Glass, Metall	● Cromo Chrome	LED 14W (2700K, CRI>80, 1400Lm)	☑ 1-10V 1-10V	385,00 €
F302345150NSLE	Vetro, Metallo Glass, Metall	● Nichel satinato Satin nickel	LED 14W (2700K, CRI>80, 1400Lm)	☑ 1-10V 1-10V	385,00 €







# PALLINA

FontanaArte Design Lab, 2019

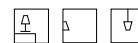

La perfezione del vetro e della sfera si uniscono nell'oggetto più essenziale della collezione, un vero e proprio must-have ideale per ogni angolo della casa. Pallina. Una, nessuna, centomila.

Lampada da parete/plafone a luce diffusa dimmerabile. Montatura in metallo galvanizzato. Diffusore in vetro soffiato satinato opalino.

The perfection of glass and sphere come together in the most essential object in the collection, a real must-have for every corner of the house. Pallina. One, none, a hundred thousand.

Dimmable wall/ceiling lamp providing diffused light. Galvanised metal fitting. Satin-finish opaline blown glass diffuser.

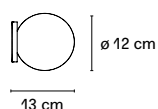

Codice Code	Materiale Material	Colore Colour	Sorgente luminosa Light source	Dimmerabile Dimmerable	Prezzo no IVA Price VAT excluded
F443060150NENE	Vetro, Metallo Galvanizzato Glass, Galvanized Metal	● Nero lucido Glossy black	1x max 6W G9	✓	225,00 €
F443060150NSNE	Vetro, Metallo Galvanizzato Glass, Galvanized Metal	● Nichel lucido Glossy nickel	1x max 6W G9	✓	225,00 €
F443060150OTNE	Vetro, Metallo Galvanizzato Glass, Galvanized Metal	● Ottone satinato Satin brass	1x max 6W G9	✓	225,00 €





# PAROLA

*Gae Aulenti e Piero Castiglioni, 1980*





La lampada Parola unisce artigianato e industria attraverso l'uso del vetro soffiato, combinando eleganza artigianale e precisione industriale in un design raffinato.

Lampada da parete a luce diffusa dimmerabile. Diffusore in vetro soffiato lucido colorato in pasta. Supporto parete in metallo nichelato.

The Parola lamp combines craftsmanship and industry through the use of blown glass, combining handcrafted elegance and industrial precision in a refined design.

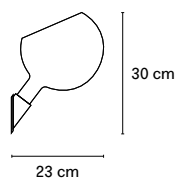
Wall lamp providing diffused dimmable light. Paste-dyed blown glass diffuser. Nickel-plated metal wall bracket.



Codice Code	Materiale Material	Colore Colour	Sorgente luminosa Light source	Dimmerabile Dimmerable	Prezzo no IVA Price VAT excluded
F268945150AMNE	Vetro Glass	 Ambra Amber	1x max 46W E14	<input checked="" type="checkbox"/>	598,00 €
F268945150BINE	Vetro Glass	 Bianco White	1x max 46W E14	<input checked="" type="checkbox"/>	598,00 €





# RIGA

Paolo Zani, 1995

Lampada da parete dal design lineare ed essenziale, con struttura in metallo e diffusori in vetro temperato sabbiato. Illuminazione verso il basso e verso l'alto.

Lampada da parete a luce diretta e indiretta dimmerabile. Montatura in acciaio. Diffusori in vetro sabbiato.

Wall lamp with linear essential design, comprising a structure in metal and diffusers in sandblasted tempered glass. Downlighting and uplighting.

Wall lamp providing direct and indirect dimmable light. Steel fitting. Sandblasted glass diffusers.

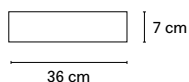

Codice Code	Materiale Material	Colore Colour	Sorgente luminosa Light source	Dimmerabile Dimmable	Prezzo no IVA Price VAT excluded
F521440250BILE	Vetro, Metallo Glass, Metall	○ Bianco White	LED 2x9W (3000K, CRI>80, 2x850Lm)	☑ A taglio di fase Phase cut dimmer	295,00 €
F521440260NSLE	Vetro, Metallo Glass, Metall	● Nichel satinato Satin nickel	LED 2x9W (3000K, CRI>80, 2x850Lm)	☑ A taglio di fase Phase cut dimmer	328,00 €



CE ENEC IP20

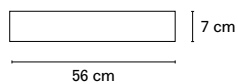

Codice Code	Materiale Material	Colore Colour	Sorgente luminosa Light source	Dimmerabile Dimmable	Prezzo no IVA Price VAT excluded
F539845250BILE	Vetro, Metallo Glass, Metall	○ Bianco White	LED 2x9W (3000K, CRI>80, 2x850Lm)	☑ A taglio di fase Phase cut dimmer	336,00 €
F539845260NSLE	Vetro, Metallo Glass, Metall	● Nichel satinato Satin nickel	LED 2x9W (3000K, CRI>80, 2x850Lm)	☑ A taglio di fase Phase cut dimmer	369,00 €



CE ENEC IP20

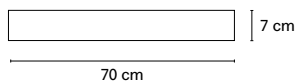

Codice Code	Materiale Material	Colore Colour	Sorgente luminosa Light source	Dimmerabile Dimmable	Prezzo no IVA Price VAT excluded
F521450250BILE	Vetro, Metallo Glass, Metall	○ Bianco White	LED 2x9,5W (3000K, CRI>80, 2x910Lm)	☑ A taglio di fase Phase cut dimmer	426,00 €
F521450260NSLE	Vetro, Metallo Glass, Metall	● Nichel satinato Satin nickel	LED 2x9,5W (3000K, CRI>80, 2x910Lm)	☑ A taglio di fase Phase cut dimmer	459,00 €



CE ENEC IP20





# SCINTILLA

Livio e Piero Castiglioni, 1972





Il sistema Scintilla ha rappresentato una novità assoluta, mettendo insieme il segno essenziale e versatile di una lampada decorativa e una capacità illuminante paragonabile a un sistema tecnico.

Lampada da parete a luce diffusa dimmerabile. Montatura in metallo. La lampada viene fornita con due differenti diffusori in vetro borosilicato trasparente e sabbato. E' possibile acquistare separatamente un riflettore in alluminio anodizzato che consente di produrre luce indiretta.

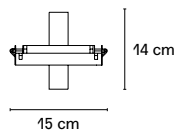
The absolutely novel Scintilla system combines the essential versatility of a decorative lamp and a lighting capacity comparable to a technical system.

Wall lamp with diffused and dimmable light. Metal frame. The lamp is supplied with two different diffusers: one in clear borosilicate glass and the other in sandblasted borosilicate glass. Available separately a reflector made of anodized aluminum that produces indirect light.







Codice Code	Materiale Material	Colore Colour	Sorgente luminosa Light source	Dimmerabile Dimmable	Prezzo no IVA Price VAT excluded
FP15045250CRNE	Vetro, Metallo Glass, Metall	 Cromo Chrome	1x max 120W R7s/80		246,00 €
FP15045250NSNE	Vetro, Metallo Glass, Metall	 Nichel satinato Satin nickel	1x max 120W R7s/115		246,00 €

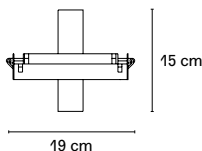

CE ENEC IP20



Codice Code	Materiale Material	Colore Colour	Sorgente luminosa Light source	Dimmerabile Dimmable	Prezzo no IVA Price VAT excluded
FP30050250CRNE	Vetro, Metallo Glass, Metall	 Cromo Chrome	1x max 230W R7s/115		287,00 €
FP30050250NSNE	Vetro, Metallo Glass, Metall	 Nichel satinato Satin nickel	1x max 230W R7s/115		287,00 €



CE ENEC IP20

Codice Code	Materiale Material	Colore Colour	Descrizione Description	Prezzo no IVA Price VAT excluded
RP15000M02AL00	Metallo Metall	 Alluminio Aluminum	Riflettore per FP15045250..NE, Reflector for FP15045250..NE	61,00 €
RP15000M02AL00	Metallo Metall	 Alluminio Aluminum	Riflettore per FP30050250..NE, Reflector for FP30050250..NE	61,00 €



# SILLABA

Piero Castiglioni, 1988

Pensata sia per l'installazione a parete che a soffitto, Sillaba unisce discrezione e purezza arredando qualsiasi interno con la sua presenza essenziale.

Lampada da parete/plafone a luce diffusa dimmerabile. Montatura in alluminio pressofuso. Diffusore in vetro borosilicato stampato sabbato esternamente. Alimentatore non incluso.

Designed for either wall or ceiling installation, Sillaba combines discretion and pureness, furnishing any room with its minimal presence.

Dimmable wall/ceiling lamp providing diffused light. Die-cast aluminium fitting. Externally sandblasted moulded borosilicate glass diffuser. Ballast not included.

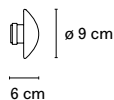

Codice Code	Materiale Material	Colore Colour	Sorgente luminosa Light source	Dimmerabile Dimmable	Prezzo no IVA Price VAT excluded
F277560150BINE	Vetro, Metallo Glass, Metal	○ Bianco White	1x max 20W G4	☑	107,00 €

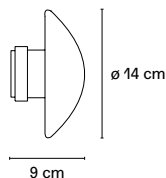

Codice Code	Materiale Material	Colore Colour	Sorgente luminosa Light source	Dimmerabile Dimmable	Prezzo no IVA Price VAT excluded
F277570150BILE	Vetro, Metallo Glass, Metal	○ Bianco White	1x max 60W G9	☑	176,00 €



Codice Code	Materiale Material	Colore Colour	Sorgente luminosa Light source	Dimmerabile Dimmable	Prezzo no IVA Price VAT excluded
F277570150BILE	Vetro, Metallo Glass, Metal	○ Bianco White	LED 1x8W (3000K, CRI>80, 650Lm)	☑ A taglio di fase Phase cut dimmer	295,00 €



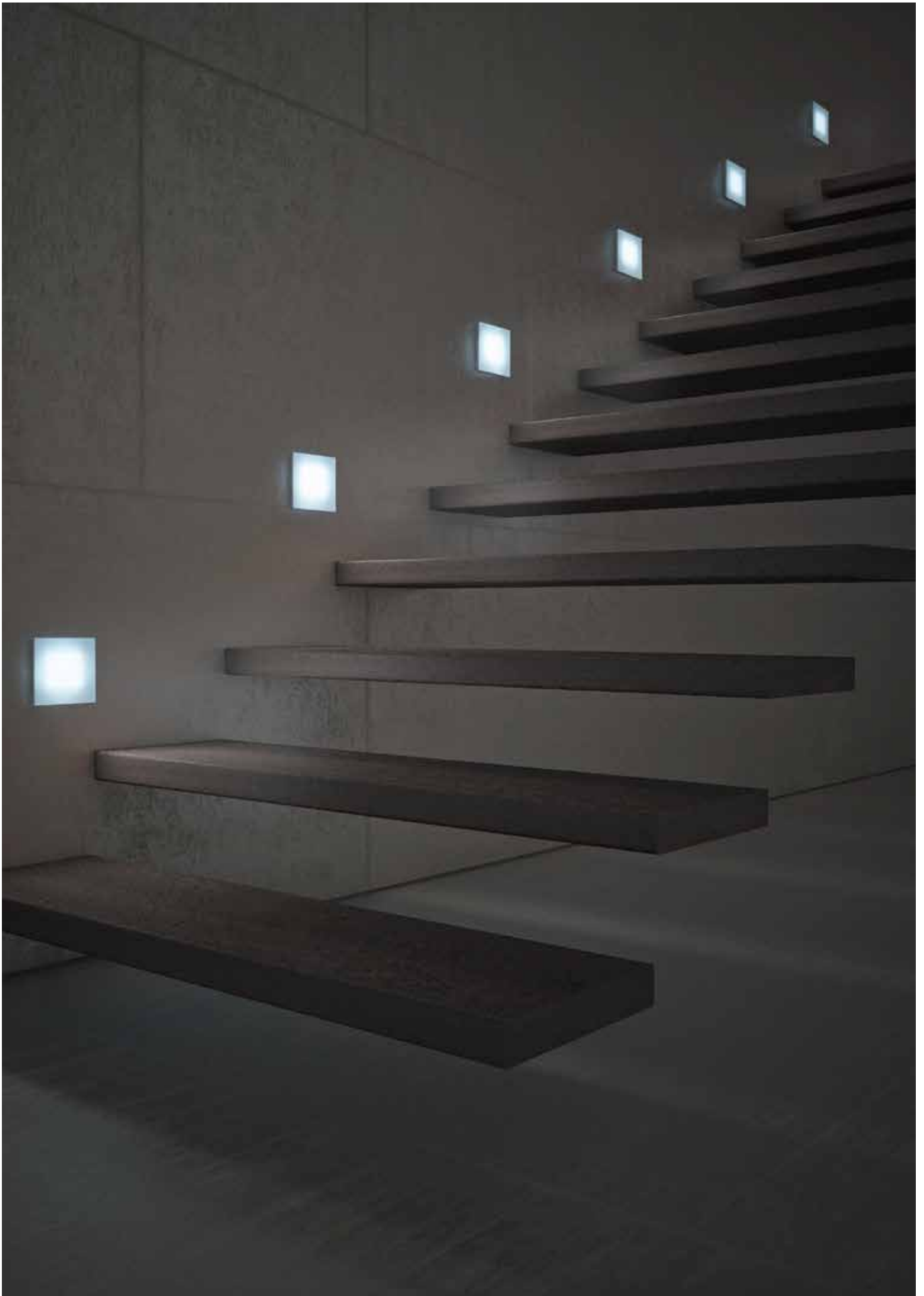

# SOLE

Bernardino Amato, 2011

Un progetto illuminotecnico e decorativo al tempo stesso. Un design essenziale con un "cuore" tecnologico grazie a una scheda Led evoluta, regolabile, a risparmio energetico e ad alta efficienza luminosa. Minuscolo e facile da installare a parete o a soffitto.

Lampada da parete/plafone a luce diffusa dimmerabile. Diffusore in vetro serigrafato.

A lighting project that is both technical and decorative. Essential design with a techno 'heart' thanks to a highly evolved Led board with adjustable, energy-saving, high luminous efficiency. Tiny and easy to install on walls or ceilings

Dimmable wall/ceiling lamp providing diffused light. Screen-printed glass diffuser.

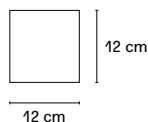

Codice Code	Materiale Material	Colore Colour	Sorgente luminosa Light source	Dimmerabile Dimmable	Prezzo no IVA Price VAT excluded
F414040150BILE	Vetro, Polimero Glass, Polymer	○ Bianco White	LED 49x9W (3000K, CRI>85, 800Lm)	☑ TRIAC TRIAC	307,00 €



Codice Code	Materiale Material	Colore Colour	Sorgente luminosa Light source	Dimmerabile Dimmable	Prezzo no IVA Price VAT excluded
F413940150BILE	Vetro, Polimero Glass, Polymer	○ Bianco White	LED 49x9W (3000K, CRI>85, 800Lm)	☑ TRIAC TRIAC	1.680,00 €



Confezione da 6 pz  
Pack of 6 pcs





# TROPICO

Gabriele e Oscar Buratti, 2020



Passando tra layer opalini, enfatizzata dalle curvature ricercate e dalla magia dei vetri soffiati, la luce è libera di creare effetti, disegni ed atmosfere sorprendenti ed affascinanti. Tropico è una calotta sferica in vetro opalino opaco, ribassata e fissata da una grande borchia in metallo a specchio.

Lampada da parete/plafone a luce diffusa dimmerabile a taglio fase. Diffusore in vetro soffiato opalino acidato. Bottone centrale in metallo galvanizzato.

Passing between opaline layers, emphasised by the refined curvatures and the magic of blown glass, light is free to create surprising and fascinating effects, patterns and atmospheres. Tropico is a spherical cap in opaque opal glass, lowered and fixed by a large mirror metal stud.

Dimmable wall/ceiling lamp providing diffused light. Acid-etched opal blown glass diffuser. Galvanised metal central button.

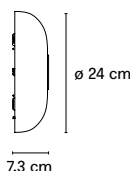

Codice Code	Materiale Material	Colore Colour	Sorgente luminosa Light source	Dimmerabile Dimmable	Prezzo no IVA Price VAT excluded
F442160550NELE	Vetro, Metallo Galvanizzato Glass, Galvanized Metall	● Nero lucido Glossy black	LED 20,5W (3000K, CRI>80, 2200Lm)	☑ A taglio di fase Phase cut dimmer	385,00 €
F442160550OOLE	Vetro, Metallo Galvanizzato Glass, Galvanized Metal	● Oro lucido Glossy gold	LED 20,5W (3000K, CRI>80, 2200Lm)	☑ A taglio di fase Phase cut dimmer	385,00 €

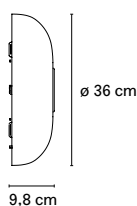

Codice Code	Materiale Material	Colore Colour	Sorgente luminosa Light source	Dimmerabile Dimmable	Prezzo no IVA Price VAT excluded
F442165550NELE	Vetro, Metallo Galvanizzato Glass, Galvanized Metall	● Nero lucido Glossy black	LED 30,5W (3000K, CRI>80, 3000Lm)	☑ A taglio di fase Phase cut dimmer	484,00 €
F442165550OOLE	Vetro, Metallo Galvanizzato Glass, Galvanized Metal	● Oro lucido Glossy gold	LED 30,5W (3000K, CRI>80, 3000Lm)	☑ A taglio di fase Phase cut dimmer	484,00 €

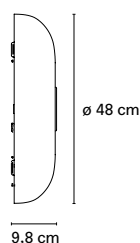

Codice Code	Materiale Material	Colore Colour	Sorgente luminosa Light source	Dimmerabile Dimmable	Prezzo no IVA Price VAT excluded
F442170550NELE	Vetro, Metallo Galvanizzato Glass, Galvanized Metall	● Nero lucido Glossy black	LED 42,5W (3000K, CRI>80, 4600Lm)	☑ A taglio di fase Phase cut dimmer	639,00 €
F442170550OOLE	Vetro, Metallo Galvanizzato Glass, Galvanized Metal	● Oro lucido Glossy gold	LED 42,5W (3000K, CRI>80, 4600Lm)	☑ A taglio di fase Phase cut dimmer	639,00 €



<b>KIT CASAMBI</b> R442100K05BI00	Casambi è un dispositivo intelligente, non è necessaria una connessione Internet ma è sufficiente attivare il Bluetooth del telefono o tablet o altri dispositivi di controllo e scaricare la App gratuita grazie alla quale le lampade potranno venire accese, spente e regolate di intensità a seconda dello scenario che si desidera nel proprio ambiente.	Casambi is an intelligent device, no Internet connection is required, simply activate the Bluetooth on your phone, tablet or other control device and download the free App to turn the lamps on and off and adjust their intensity according to the scenario you want to create in your environment.	128,00 €
--------------------------------------	---	---	----------

## LAMPADE A PLAFONE / CEILING LAMPS

BIANCA	p. 168
FONTANELLA	p. 170
LUNAIRE	p. 172
PALLINA	p. 174
PANGEN	p. 176
SILLABA	p. 178
SOLE	p. 180
TROPICO	p. 183

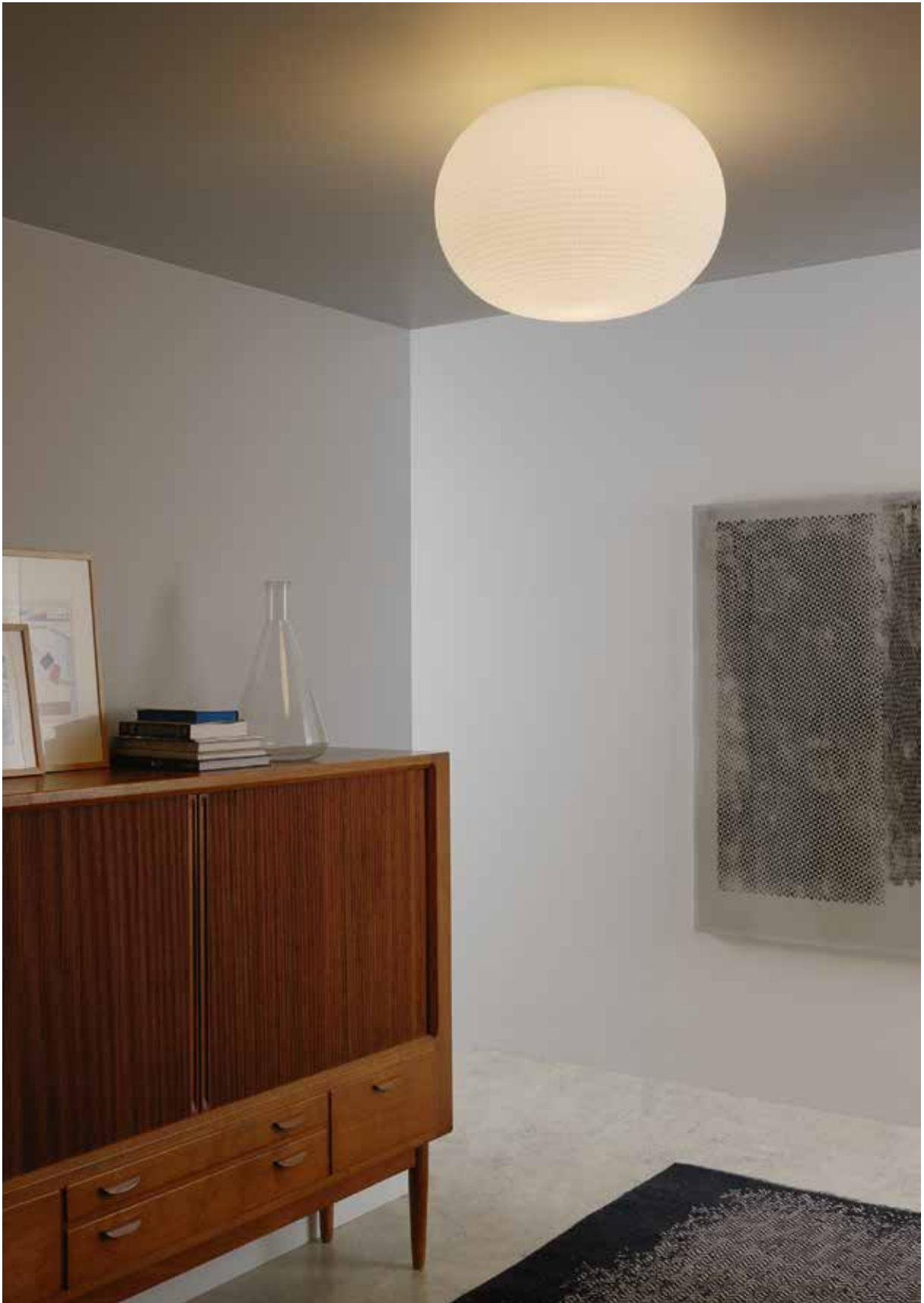

# BIANCA

Matti Klenell, 2015



Bianca è una famiglia di lampade la cui decorazione sulla superficie del diffusore è caratterizzata da una serie ordinata di solchi poco profondi e delicati incisi nel vetro bianco, che creano un effetto che ricorda piccole impronte sulla neve fresca. Soffiati a bocca e immersi in acido per ottenere il caratteristico "effetto seta" tipico della vetreria pregiata, i diffusori Bianca sono disponibili in tre diametri diversi per completare tutte le tipologie di lampade appartenenti alla famiglia.

Lampada da parete/plafone a luce diffusa dimmerabile. Diffusore in vetro incamiciato di colore bianco latte, soffiato a fermo e satinato. Montatura in metallo verniciato.

Bianca is a family of luminaires with the decoration on the diffuser surface features an orderly series of shallow delicate grooves etched into the white glass, yielding an effect resembling small footprints on fresh snow. Mouth blown and dipped in acid to obtain the distinctive 'silk effect' typical of fine glassware, Bianca diffusers are available in three different diameters to complete all types of luminaires belonging to the family.

Dimmable wall/ceiling lamp providing diffused light. Milk-white diffuser made of blown glass with satin-finish. Painted metal frame.

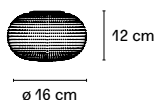

Codice Code	Materiale Material	Colore Colour	Sorgente luminosa Light source	Dimmerabile Dimmable	Prezzo no IVA Price VAT excluded
F432860150BINE	Vetro, Metallo Glass, Metal	○ Bianco White	1x max 30W G9	☑	242,00 €

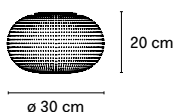

Codice Code	Materiale Material	Colore Colour	Sorgente luminosa Light source	Dimmerabile Dimmable	Prezzo no IVA Price VAT excluded
F432865150BINE	Vetro, Metallo Glass, Metal	○ Bianco White	1x max 46W E27	☑	328,00 €

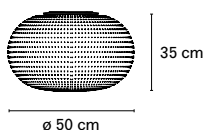

Codice Code	Materiale Material	Colore Colour	Sorgente luminosa Light source	Dimmerabile Dimmable	Prezzo no IVA Price VAT excluded
F432870150BINE	Vetro, Metallo Glass, Metal	○ Bianco White	1x max 116W E27	☑	598,00 €





# FONTANELLA

Federico Peri, 2020

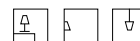

Due materiali: metallo e vetro, come nella storica tradizione di FontanaArte. Il metallo funge da corpo mentre il vetro, vero protagonista del progetto, viene sapientemente lavorato da abili artigiani in un processo di fusione fra una porzione di vetro trasparente ed una satinata dalla quale la luce si diffonde. Fontanella è formata dall'unione di due vetri: il tubo interno viene filettato, sabbiato ed infine giuntato con il vetro soffiato a forma di bolla.

Lampada da parete e plafone a luce diffusa dimmerabile. Montatura in metallo galvanizzato. Diffusore in vetro soffiato in borisilicato.

Due materiali: metallo e vetro, nella storica tradizione di FontanaArte. Il metallo funge da corpo mentre il vetro, vero protagonista del progetto, viene sapientemente lavorato da abili artigiani in un processo di fusione tra una porzione di vetro trasparente e una porzione satinata da cui si diffonde la luce. Fontanella si forma unendo due pezzi di vetro: il tubo interno viene infilato, sabbiato e infine unito al vetro soffiato a forma di bolla.

Wall an ceiling lamp with dimmable diffused light. Galvanized metal frame. Borosilicate blown glass diffuser.

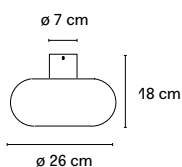

Codice Code	Materiale Material	Colore Colour	Sorgente luminosa Light source	Dimmerabile Dimmable	Prezzo no IVA Price VAT excluded
F447745550NENE	Vetro, Metallo Galvanizzato Glass, Galvanized Metal	● Nero lucido Glossy black	1x max 28W E14	☑	430,00 €
F447745550OTNE	Vetro, Metallo Galvanizzato Glass, Galvanized Metal	● Ottone satinato Satin Brass	1x max 28W E14	☑	447,00 €



CE IP20

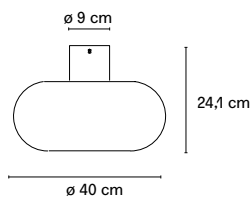

Codice Code	Materiale Material	Colore Colour	Sorgente luminosa Light source	Dimmerabile Dimmable	Prezzo no IVA Price VAT excluded
F447750550NENE	Vetro, Metallo Galvanizzato Glass, Galvanized Metal	● Nero lucido Glossy black	1x max 77W E27	☑	643,00 €
F447750550OTNE	Vetro, Metallo Galvanizzato Glass, Galvanized Metal	● Ottone satinato Satin Brass	1x max 77W E27	☑	660,00 €



CE IP20





# LUNAIRE

Farrèol Babin, 2013

Lunaire è una lampada da parete e plafone che stupisce per il suo effetto luminoso che ricorda il fenomeno di luce prodotto dalle eclissi. Lunaire, grazie al generoso diametro del diffusore, è una lampada adatta all'illuminazione di grandi spazi, siano essi domestici o in ambito contract.

Lampada da parete/plafone. Corpo posteriore in polietilene, riflettore e tappo fisso in metallo verniciato.

Lunaire is a wall and ceiling lamp that impresses with its lighting effect reminiscent of the luminous phenomenon produced by eclipses. Thanks to the generous diameter of the diffuser, Lunaire is a lamp suitable for illuminating large spaces, both domestic and contract.

Wall/ceiling lamp. Back body in polyethylene, reflector and fixed cap in painted metal.

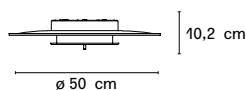

Codice Code	Materiale Material	Colore Colour	Sorgente luminosa Light source	Dimmerabile Dimmable	Prezzo no IVA Price VAT excluded
F424660350BILE	Polimero, Metallo Verniciato Polymer, Painted Metal	○ Bianco White	LED 10W (2700K, CRI 80, 1250Lm)	✓ TRIAC TRIAC	533,00 €





# PALLINA

FontanaArte Design Lab, 2019



La perfezione del vetro e della sfera si uniscono nell'oggetto più essenziale della collezione, un vero e proprio must-have ideale per ogni angolo della casa. Pallina. Una, nessuna, centomila.

Lampada da parete/plafone a luce diffusa dimmerabile. Montatura in metallo galvanizzato. Diffusore in vetro soffiato satinato opalino.

The perfection of glass and sphere come together in the most essential object in the collection, a real must-have for every corner of the house. Pallina. One, none, a hundred thousand.

Dimmable wall/ceiling lamp providing diffused light. Galvanised metal fitting. Satin-finish opaline blown glass diffuser.

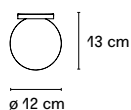

Codice Code	Materiale Material	Colore Colour	Sorgente luminosa Light source	Dimmerabile Dimmerable	Prezzo no IVA Price VAT excluded
F443060150NENE	Vetro, Metallo Galvanizzato Glass, Galvanized Metal	● Nero lucido Glossy black	1x max 6W G9	✓	225,00 €
F443060150NSNE	Vetro, Metallo Galvanizzato Glass, Galvanized Metal	● Nichel lucido Glossy nickel	1x max 6W G9	✓	225,00 €
F443060150OTNE	Vetro, Metallo Galvanizzato Glass, Galvanized Metal	● Ottone satinato Satin brass	1x max 6W G9	✓	225,00 €





# PANGEN

*Historical Archive, 1969*



Il paralume di Pangen è una cupola dalla forma fluida e minimale la cui finitura laccata, proposta in diversi colori, regala riflessi di luce sorprendenti. Disponibile in versione sospensione e plafone.

Lampada a plafone a luce diretta dimmerabile. Diffusore superiore in metallo verniciato. Diffusore inferiore in policarbonato opalino. Attacco a soffitto in metallo cromato.

Pangen's lampshade is a dome with a fluid and minimalist shape whose lacquered finish, available in different colours, gives surprising reflections of light. Available in suspension and ceiling versions.

Ceiling lamp providing direct dimmable light. upper diffuser of painted metal. Opal polycarbonate lower diffuser. Chrome metal ceiling fitting.

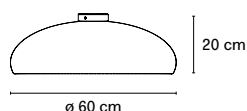

Codice Code	Materiale Material	Colore Colour	Sorgente luminosa Light source	Dimmerabile Dimmable	Prezzo no IVA Price VAT excluded
F419766350BINE	Polimero, Metallo Polymer, Metal	○ Bianco White	3x max 46W E27	✓	672,00 €
F419766350NENE	Polimero, Metallo Polymer, Metal	● Nero Black	3x max 46W E27	✓	672,00 €
F419766350RONE	Polimero, Metallo Polymer, Metal	● Rosso red	3x max 46W E27	✓	672,00 €



CE ENEC IP20



# SILLABA

Piero Castiglioni, 1988

Pensata sia per l'installazione a parete che a soffitto, Sillaba unisce discrezione e purezza arredando qualsiasi interno con la sua presenza essenziale.

Lampada da parete/plafone a luce diffusa dimmerabile. Montatura in materiale termoplastico. Diffusore in vetro borosilicato stampato sabbato esternamente. Alimentatore non incluso.

Designed for either wall or ceiling installation, Sillaba combines discretion and pureness, furnishing any room with its minimal presence.

Dimmable wall/ceiling lamp providing diffused light. Thermoplastic material fitting. Printed borosilicate glass diffuser externally sandblasted. Ballast not included.

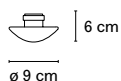

Codice Code	Materiale Material	Colore Colour	Sorgente luminosa Light source	Dimmerabile Dimmable	Prezzo no IVA Price VAT excluded
F277560150BINE	Vetro, Metallo Glass, Metal	○ Bianco White	1x max 20W G4	☑	107,00 €

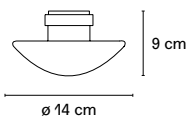

Codice Code	Materiale Material	Colore Colour	Sorgente luminosa Light source	Dimmerabile Dimmable	Prezzo no IVA Price VAT excluded
F277570150BILE	Vetro, Metallo Glass, Metal	○ Bianco White	1x max 60W G9	☑	176,00 €



Codice Code	Materiale Material	Colore Colour	Sorgente luminosa Light source	Dimmerabile Dimmable	Prezzo no IVA Price VAT excluded
F277570150BILE	Vetro, Metallo Glass, Metal	○ Bianco White	LED 1x8W (3000K, CRI>80, 650Lm)	☑ A taglio di fase Phase cut dimmer	295,00 €







# SOLE

Bernardino Amato, 2011

Un progetto illuminotecnico e decorativo al tempo stesso. Un design essenziale con un "cuore" tecnologico grazie a una scheda Led evoluta, regolabile, a risparmio energetico e ad alta efficienza luminosa. Minuscolo e facile da installare a parete o a soffitto.

Lampada da parete/plafone a luce diffusa dimmerabile. Montatura in Corian. Diffusore in vetro serigrafato.

A lighting project that is both technical and decorative. Essential design with a techno 'heart' thanks to a highly evolved Led board with adjustable, energy-saving, high luminous efficiency. Tiny and easy to install on walls or ceilings

Dimmable wall/ceiling lamp providing diffused light. Corian fitting. Screen-printed glass diffuser.

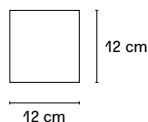

Codice Code	Materiale Material	Colore Colour	Sorgente luminosa Light source	Dimmerabile Dimmable	Prezzo no IVA Price VAT excluded
F414040150BILE	Vetro, Polimero Glass, Polymer	○ Bianco White	LED 49x9W (3000K, CRI>85, 800Lm)	☑ TRIAC TRIAC	307,00 €



Codice Code	Materiale Material	Colore Colour	Sorgente luminosa Light source	Dimmerabile Dimmable	Prezzo no IVA Price VAT excluded
F413940150BILE	Vetro, Polimero Glass, Polymer	○ Bianco White	LED 49x9W (3000K, CRI>85, 800Lm)	☑ TRIAC TRIAC	1.680,00 €



Confezione da 6 pz  
Pack of 6 pcs

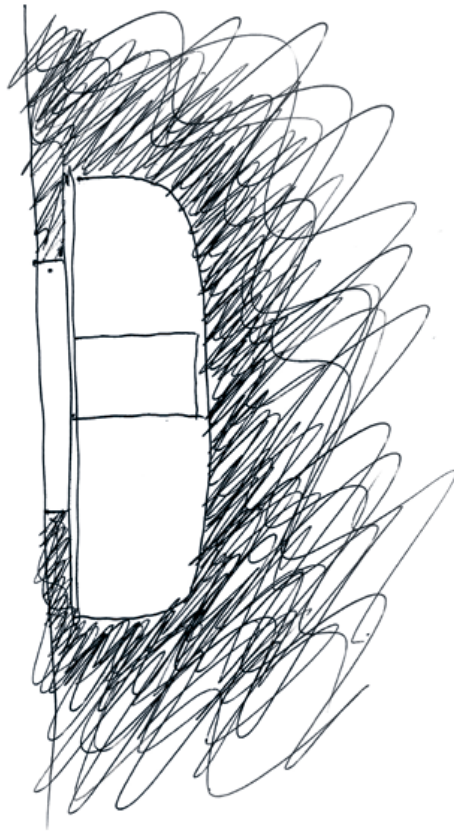



# TROPICO

Gabriele e Oscar Buratti, 2020



Passando tra layer opalini, enfatizzata dalle curvature ricercate e dalla magia dei vetri soffiati, la luce è libera di creare effetti, disegni ed atmosfere sorprendenti ed affascinanti. Tropico è una calotta sferica in vetro opalino opaco, ribassata e fissata da una grande borchia in metallo a specchio.

Lampada da parete/plafone a luce diffusa dimmerabile a taglio fase. Diffusore in vetro soffiato opalino acidato. Bottone centrale in metallo galvanizzato.

Passing between opaline layers, emphasised by the refined curvatures and the magic of blown glass, light is free to create surprising and fascinating effects, patterns and atmospheres. Tropico is a spherical cap in opaque opal glass, lowered and fixed by a large mirror metal stud.

Dimmable wall/ceiling lamp providing diffused light. Acid-etched opal blown glass diffuser. Galvanised metal central button.

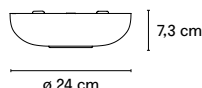

Codice Code	Materiale Material	Colore Colour	Sorgente luminosa Light source	Dimmerabile Dimmable	Prezzo no IVA Price VAT excluded
F442160550NELE	Vetro, Metallo Galvanizzato Glass, Galvanized Metall	● Nero lucido Glossy black	LED 20,5W (3000K, CRI>80, 2200Lm)	☑ A taglio di fase Phase cut dimmer	385,00 €
F442160550OOLE	Vetro, Metallo Galvanizzato Glass, Galvanized Metal	● Oro lucido Glossy gold	LED 20,5W (3000K, CRI>80, 2200Lm)	☑ A taglio di fase Phase cut dimmer	385,00 €

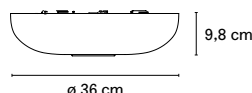

Codice Code	Materiale Material	Colore Colour	Sorgente luminosa Light source	Dimmerabile Dimmable	Prezzo no IVA Price VAT excluded
F442165550NELE	Vetro, Metallo Galvanizzato Glass, Galvanized Metall	● Nero lucido Glossy black	LED 30,5W (3000K, CRI>80, 3000Lm)	☑ A taglio di fase Phase cut dimmer	484,00 €
F442165550OOLE	Vetro, Metallo Galvanizzato Glass, Galvanized Metal	● Oro lucido Glossy gold	LED 30,5W (3000K, CRI>80, 3000Lm)	☑ A taglio di fase Phase cut dimmer	484,00 €

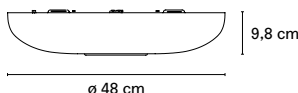

Codice Code	Materiale Material	Colore Colour	Sorgente luminosa Light source	Dimmerabile Dimmable	Prezzo no IVA Price VAT excluded
F442170550NELE	Vetro, Metallo Galvanizzato Glass, Galvanized Metall	● Nero lucido Glossy black	LED 42,5W (3000K, CRI>80, 4600Lm)	☑ A taglio di fase Phase cut dimmer	639,00 €
F442170550OOLE	Vetro, Metallo Galvanizzato Glass, Galvanized Metal	● Oro lucido Glossy gold	LED 42,5W (3000K, CRI>80, 4600Lm)	☑ A taglio di fase Phase cut dimmer	639,00 €



<b>KIT CASAMBI</b> R442100K05BI00	Casambi è un dispositivo intelligente, non è necessaria una connessione Internet ma è sufficiente attivare il Bluetooth del telefono o tablet o altri dispositivi di controllo e scaricare la App gratuita grazie alla quale le lampade potranno venire accese, spente e regolate di intensità a seconda dello scenario che si desidera nel proprio ambiente.	Casambi is an intelligent device, no Internet connection is required, simply activate the Bluetooth on your phone, tablet or other control device and download the free App to turn the lamps on and off and adjust their intensity according to the scenario you want to create in your environment.	128,00 €
--------------------------------------	---	---	----------

# LAMPADE A SOSPENSIONE / SUSPENSION LAMPS

0024	p. 186
AMAX	p. 189
AVICO	p. 193
BIANCA	p. 195
BOLLA	p. 198
CHANDELIER	p. 200
EQUATORE	p. 203
FLÛTE	p. 205
FONTANELLA	p. 209
GLOBO DI LUCE	p. 211
HUNA	p. 214
LAMPARA	p. 216
MERIDIANO	p. 218
OORT SISTEMA	p. 221
PALLINA	p. 226
PANGEN	p. 228
PAROLA	p. 230
PINECONE	p. 232
SCINTILLA	p. 235
SETAREH	p. 237
THALEA	p. 239



*Grande lampada in cristallo.*

alla XII Fiera di Milano

uno degli stand più importanti nel Palazzo delle Cinque Gallerie è quello allestito dalla Società Anonima

**LUIGI FONTANA & C.**

VIA PRIVATA G. BUCATTI, 8 (61) Via Tortona, 21) - Telefoni: 30462, 30474, 32437

**MILANO**







# 0024

Gio Ponti, 1933

Sequenza di dischi orizzontali in vetro temperato trasparente per un'autentica installazione luminosa. Un protagonismo deciso per arredare anche spazi di grandi dimensioni con un'eleganza intramontabile.

Lampada a sospensione a luce diffusa. Montatura e rosone in ottone cromato. Cavo di sospensione in acciaio. Dischi in vetro temperato trasparente. Diffusore centrale cilindrico in vetro termoresistente sabbiato. Cavo di alimentazione trasparente.

A sequence of horizontal discs in transparent tempered glass for an authentic light installation. A bold protagonism to furnish even large spaces with timeless elegance.

Suspension lamp providing diffused light. Chrome-plated brass fitting and rosette. Steel suspension cable. Transparent tempered glass discs. Cylindrical central diffuser of sand-blasted heat-resistant glass. Transparent power cable.

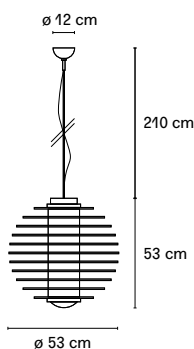

Codice Code	Materiale Material	Colore Colour	Sorgente luminosa Light source	Dimmerabile Dimmable	Prezzo no IVA Price VAT excluded
F002485150TRNE	Vetro, Metallo Glass, Metal	Trasparente Transparent	2x max 36W 2G11	⊗	2.090,00 €

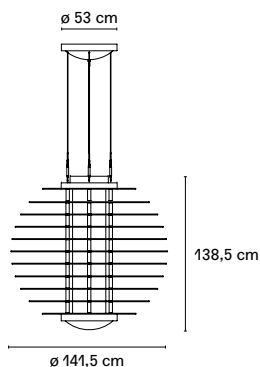

Codice Code	Materiale Material	Colore Colour	Sorgente luminosa Light source	Dimmerabile Dimmable	Prezzo no IVA Price VAT excluded
S0024.....	Vetro, Metallo Glass, Metal	Trasparente Transparent	4x max 54W G5	⊙ DALI DALI	SU RICHIESTA ON REQUEST







# AMAX

Charles William, 2003

Interpretazione extralarge del classico paralume FontanaArte, Amax è una famiglia di lampade da sospensione che prevede, nelle misure più grandi, un disco di chiusura inferiore che copre la vista delle sorgenti luminose.

Lampada a sospensione a luce diffusa dimmerabile. Montatura in metallo cromato. Diffusore in polietilene bianco. Cavo di sospensione in acciaio. Cavo di alimentazione in tessuto rosso. Rosone in materiale termoplastico cromato. E' possibile acquistare separatamente un disco di chiusura opzionale in policarbonato con tige telescopica e tappo di ancoraggio.

An extra-large interpretation of the classic FontanaArte lampshade, Amax is a family of pendant lamps that includes, in the largest sizes, a lower closing disc that covers the view of the light sources.

Suspension lamp providing diffused dimmable light. Chrome metal fitting. White polyethylene diffuser. Steel suspension cable. Red fabric power cable. Chrome-plated thermoplastic ceiling rose. An optional polycarbonate closing disc with telescopic tige and anchor cap can be purchased separately

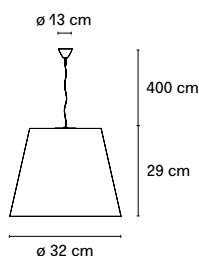

Codice Code	Materiale Material	Colore Colour	Sorgente luminosa Light source	Dimmerabile Dimmable	Prezzo no IVA Price VAT excluded
F544480350BINE	Polimero, Metallo Polymer, Metal	○ Bianco White	1x max 100W E27	☑	402,00 €

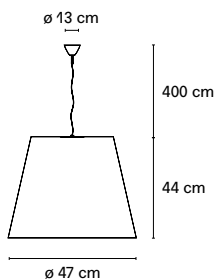

Codice Code	Materiale Material	Colore Colour	Sorgente luminosa Light source	Dimmerabile Dimmable	Prezzo no IVA Price VAT excluded
F544485350BINE	Polimero, Metallo Polymer, Metal	○ Bianco White	1x max 150W E27	☑	541,00 €



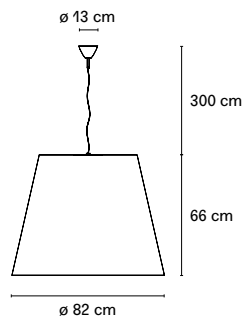

Codice Code	Materiale Material	Colore Colour	Sorgente luminosa Light source	Dimmerabile Dimmable	Prezzo no IVA Price VAT excluded
F544490350BINE	Polimero, Metallo Polymer, Metal	○ Bianco White	3x max 100W E27	☑	902,00 €

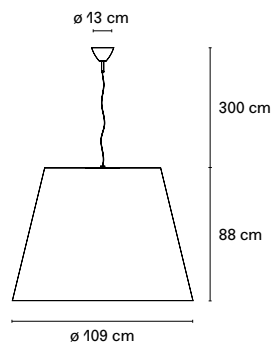

Codice Code	Materiale Material	Colore Colour	Sorgente luminosa Light source	Dimmerabile Dimmable	Prezzo no IVA Price VAT excluded
F544495350BINE	Polimero, Metallo Polymer, Metal	○ Bianco White	3x max 150W E27	☑	1.311,00 €

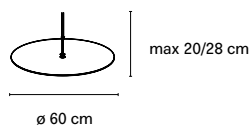

Codice Code	Materiale Material	Colore Colour	Descrizione Description	Prezzo no IVA Price VAT excluded
R556201K00CB00	Polimero, Metallo Polymer, Metall	◐ Cromo, Bianco Chrome, White	Disco di chiusura con tige telescopica per F544490350BINE Closing disk with telescopic stem for F544490350BINE	365,00 €

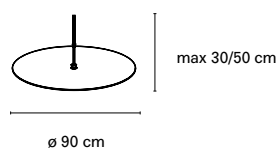

Codice Code	Materiale Material	Colore Colour	Descrizione Description	Prezzo no IVA Price VAT excluded
R556200K00CB00	Polimero, Metallo Polymer, Metall	◐ Cromo, Bianco Chrome, White	Disco di chiusura con tige telescopica per F544495350BINE Closing disk with telescopic stem for F544495350BINE	447,00 €



# AVICO

*Charles Williams, 2006*

Lampada a sospensione dal grande impatto scenico grazie ai due diametri disponibili (da 120 e 160 centimetri). Diffusore su richiesta anche argento e oro. E' possibile acquistare separatamente un disco di chiusura inferiore per coprire la vista delle sorgenti luminose.

Lampada a sospensione a luce diretta e diffusa dimmerabile. Montatura in metallo cromato. Diffusore in polietilene. E' possibile acquistare separatamente un disco di chiusura opzionale in policarbonato con tige telescopica e tappo di ancoraggio. Cavo di sospensione in acciaio. Cavo di alimentazione trasparente. Rosone in materiale termoplastico metallizzato.

Suspension lamp with great scenic impact thanks to the two available diameters (120 and 160 centimetres). Diffuser also available in silver and gold on request. A lower closing disc can be purchased separately to cover the view of the light sources.

Suspension lamp providing direct and diffused dimmable light. Chrome metal fitting. Polyethylene diffuser. An optional polycarbonate closing disc with telescopic tube and anchor cap can be purchased separately. Steel suspension cable. Transparent power cable. Rosette in metallised thermoplastic material.





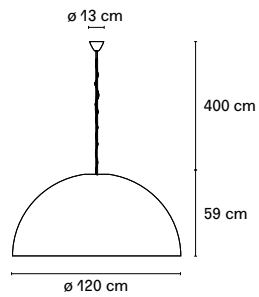

Codice Code	Materiale Material	Colore Colour	Sorgente luminosa Light source	Dimmerabile Dimmable	Prezzo no IVA Price VAT excluded
F556180350BINE	Polimero, Metallo Polymer, Metal	○ Bianco White	3x max 150W E27	☑	1.197,00 €
F556180375NENE	Polimero, Metallo Polymer, Metal	● Nero Black	3x max 150W E27	☑	2.172,00 €

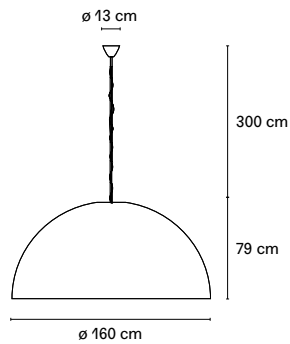

Codice Code	Materiale Material	Colore Colour	Sorgente luminosa Light source	Dimmerabile Dimmable	Prezzo no IVA Price VAT excluded
F556185350BINE	Polimero, Metallo Polymer, Metal	○ Bianco White	3x max 150W E27	☑	1.762,00 €
F556185375NENE	Polimero, Metallo Polymer, Metal	● Nero Black	3x max 150W E27	☑	3.033,00 €

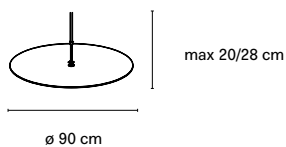

Codice Code	Materiale Material	Colore Colour	Descrizione Description	Prezzo no IVA Price VAT excluded
R556203K00CB00	Polimero, Metallo Polymer, Metall	◐ Cromo, Bianco Chrome, White	Disco di chiusura con tige telescopica per F556185350BINE e F556185375NENE Closing disk with telescopic stem for F556185350BINE and F556185375NENE	447,00 €

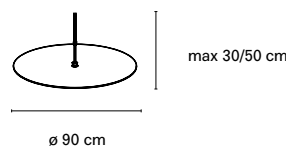

Codice Code	Materiale Material	Colore Colour	Descrizione Description	Prezzo no IVA Price VAT excluded
R556200K00CB00	Polimero, Metallo Polymer, Metall	◐ Cromo, Bianco Chrome, White	Disco di chiusura con tige telescopica per F556185350BINE e F556185375NENE Closing disk with telescopic stem for F556185350BINE and F556185375NENE	447,00 €





# BIANCA

Matti Klenell, 2015



Bianca è una famiglia di lampade la cui decorazione sulla superficie del diffusore è caratterizzata da una serie ordinata di solchi poco profondi e delicati incisi nel vetro bianco, che creano un effetto che ricorda piccole impronte sulla neve fresca. Soffiati a bocca e immersi in acido per ottenere il caratteristico "effetto seta" tipico della vetreria pregiata, i diffusori Bianca sono disponibili in tre diametri diversi per completare tutte le tipologie di lampade appartenenti alla famiglia.

Lampada a sospensione a luce diffusa dimmerabile. Diffusore in vetro incamiciato di colore bianco latte, soffiato a fermo e satinato. Cavo di alimentazione trasparente. Rosone in policarbonato verniciato.

Bianca is a family of luminaires with the decoration on the diffuser surface features an orderly series of shallow delicate grooves etched into the white glass, yielding an effect resembling small footprints on fresh snow. Mouth blown and dipped in acid to obtain the distinctive 'silk effect' typical of fine glassware, Bianca diffusers are available in three different diameters to complete all types of luminaires belonging to the family.

Suspension lamp providing diffused dimmable light. Satin-blown, milk-white layered glass diffuser. Transparent power cable. Painted polycarbonate ceiling rose.

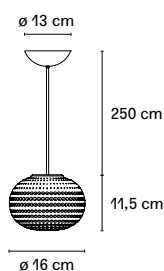

Codice Code	Materiale Material	Colore Colour	Sorgente luminosa Light source	Dimmerabile Dimmable	Prezzo no IVA Price VAT excluded
F430680150BINE	Vetro, Metallo Glass, Metal	○ Bianco White	1x max 30W G9	☑	275,00 €



CE IP20

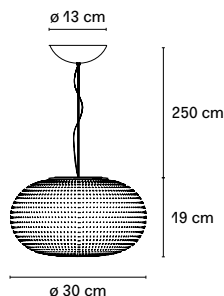

Codice Code	Materiale Material	Colore Colour	Sorgente luminosa Light source	Dimmerabile Dimmable	Prezzo no IVA Price VAT excluded
F430680150BINE	Vetro, Metallo Glass, Metal	○ Bianco White	1x max 46W E27	☑	426,00 €



CE  IP20

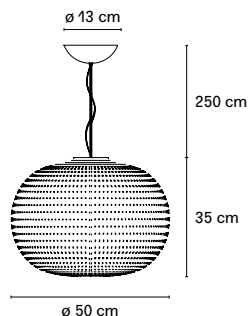

Codice Code	Materiale Material	Colore Colour	Sorgente luminosa Light source	Dimmerabile Dimmable	Prezzo no IVA Price VAT excluded
F430690150BINE	Vetro, Metallo Glass, Metal	○ Bianco White	1x max 116W E27	☑	631,00 €



CE IP20



# BOLLA

Studio Harry-Paul, 2003

Questa lampada a sospensione si chiama Bolla perché il suo diffusore in vetro soffiato trasparente ha un effetto iridescente che ricorda l'effetto delle bolle di sapone.

Lampada a sospensione a luce diffusa dimmerabile. Diffusore in vetro soffiato a fermo trasparente con effetto iridescente. Cavi di sospensione in acciaio. Cavo di alimentazione tessuto blu. Rosone in materiale termoplastico cromato.

This pendant lamp is called Bolla because its transparent blown glass diffuser has an iridescent effect reminiscent of soap bubbles.

Suspension lamp providing diffused dimmable light. Transparent still-blown glass diffuser with iridescent effect. Steel suspension cables. Blue fabric power cable. Chrome-plated thermoplastic material ceiling rose.

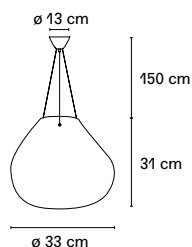

Codice Code	Materiale Material	Colore Colour	Sorgente luminosa Light source	Dimmerabile Dimmable	Prezzo no IVA Price VAT excluded
F354085100TRNE	Vetro Glass	Trasparente Transparent	1x max 77W E27	☑	607,00 €



CE ENEC IP20

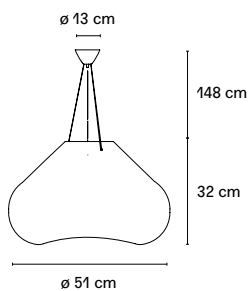

Codice Code	Materiale Material	Colore Colour	Sorgente luminosa Light source	Dimmerabile Dimmable	Prezzo no IVA Price VAT excluded
F354090100TRNE	Vetro Glass	Trasparente Transparent	1x max 77W E27	☑	730,00 €



CE ENEC IP20



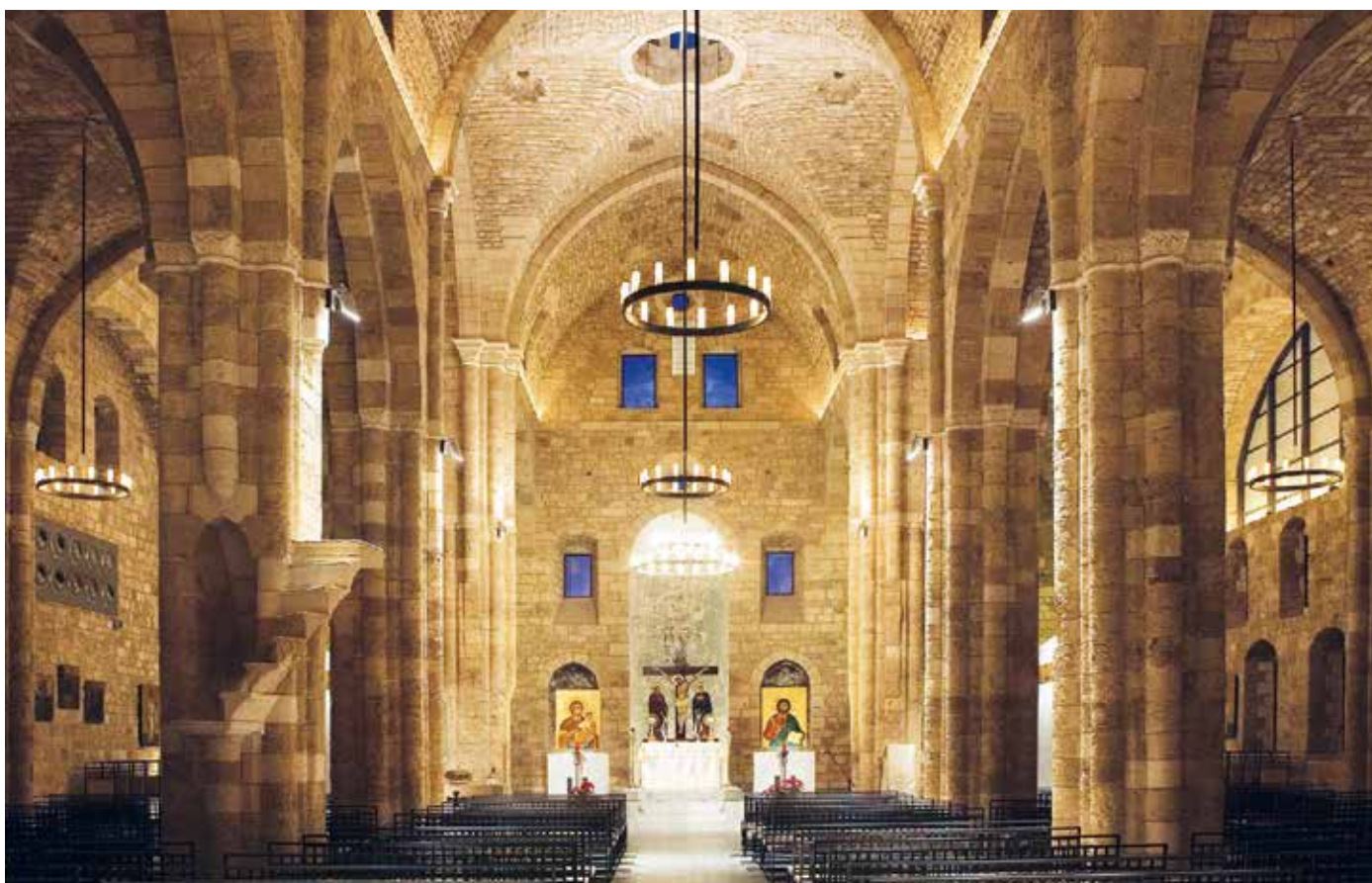



# CHANDELIER

*David Chipperfield, 2004*

Si ispira ai lampadari della corte di re Artù lo scenografico lampadario disegnato da David Chipperfield. Disponibile in due colori, nella versione singola o doppia con due cerchi concentrici, illumina con classe ed eleganza qualsiasi ambiente, anche quello più moderno e minimale.

Lampada a sospensione a luce indiretta dimmerabile. Montatura in metallo verniciato. Diffusori in vetro borosilicato sabbato. Cavi di sospensione in acciaio. Cavo di alimentazione trasparente. Rosone in metallo verniciato.

Inspired by the chandeliers of King Arthur's court, the spectacular chandelier designed by David Chipperfield. Available in two colours, in the single or double version with two concentric circles, it illuminates any environment with class and elegance, even the most modern and minimalist.

Suspension lamp with indirect and dimmable light. Painted metal frame. Sandblasted borosilicate glass diffusers. Steel suspension cable. Transparent power cable. Painted metal ceiling rose.



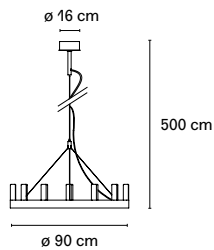

Codice Code	Materiale Material	Colore Colour	Sorgente luminosa Light source	Dimmerabile Dimmable	Prezzo no IVA Price VAT excluded
F549180250NBNE	Metallo Verniciato, Vetro Painted Metal, Glas	● Nero, Bianco Black, White	14x max 40W E14	☑	2.910,00 €
F549180260OBNE	Metallo Verniciato, Vetro Painted Metal, Glas	● Oro, Bianco Glod, White	14x max 40W E14	☑	3.074,00 €

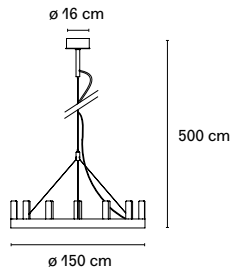

Codice Code	Materiale Material	Colore Colour	Sorgente luminosa Light source	Dimmerabile Dimmable	Prezzo no IVA Price VAT excluded
F549185250NBNE	Metallo Verniciato, Vetro Painted Metal, Glas	● Nero, Bianco Black, White	19x max 40W E14	☑	3.852,00 €
F549185260OBNE	Metallo Verniciato, Vetro Painted Metal, Glas	● Oro, Bianco Glod, White	19x max 40W E14	☑	3.975,00 €

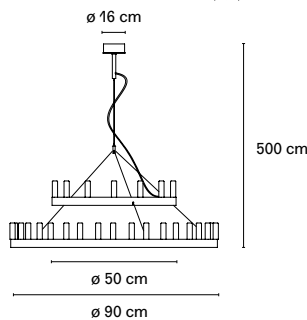

Codice Code	Materiale Material	Colore Colour	Sorgente luminosa Light source	Dimmerabile Dimmable	Prezzo no IVA Price VAT excluded
F549190250NBNE	Metallo Verniciato, Vetro Painted Metal, Glas	● Nero, Bianco Black, White	8x max 40W E14 + 14x max 40W E14	☑	4.672,00 €
F549190260OBNE	Metallo Verniciato, Vetro Painted Metal, Glas	● Oro, Bianco Glod, White	8x max 40W E14 + 14x max 40W E14	☑	4.959,00 €

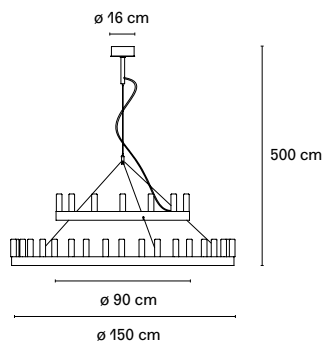

Codice Code	Materiale Material	Colore Colour	Sorgente luminosa Light source	Dimmerabile Dimmable	Prezzo no IVA Price VAT excluded
F549195250NBNE	Metallo Verniciato, Vetro Painted Metal, Glas	● Nero, Bianco Black, White	14x max 40W E14 + 19x max 40W E14	☑	6.230,00 €
F549190260OBNE	Metallo Verniciato, Vetro Painted Metal, Glas	● Oro, Bianco Glod, White	14x max 40W E14 + 19x max 40W E14	☑	6.639,00 €



# EQUATORE

*Gabriele e Oscar Buratti, 2017*



Reinterpretazione in chiave contemporanea delle classiche lampade con paralume in vetro. Se nelle tradizionali abat-jour il diffusore alloggia al suo interno la sorgente luminosa, in questa famiglia di lampade il diffusore è paradossalmente e suggestivamente vuoto e l'effetto luminoso è prodotto da due dischi luminosi all'interno di una fascia metallica centrale, visibile sul paralume e che richiama la linea dell'equatore.

Lampada a sospensione a luce diffusa dimmerabile prodotta da led inseriti all'interno di due dischi in policarbonato sovrapposti. Il disco inferiore produce un'emissione luminosa verso il basso, quello superiore illumina la calotta di vetro. Montatura in metallo. Diffusore in vetro trasparente colorato. Cavo di sospensione in acciaio. Cavo di alimentazione nero. Rosone in metallo verniciato bianco.

A contemporary reinterpretation of the classic lamp with glass shade. While in traditional abat-jours the diffuser houses the light source inside, in this family of lamps the diffuser is paradoxically and suggestively empty and the luminous effect is produced by two luminous discs within a central metal band, visible on the lampshade and recalling the line of the equator.

Suspension lamp with dimmable diffused light produced by LEDs inserted inside two overlapping polycarbonate discs. The lower disc produces a downward light emission, the upper disc illuminates the glass canopy. Metal frame. Transparent coloured glass diffuser. Steel suspension cable. Black power cable. White painted metal ceiling rose.



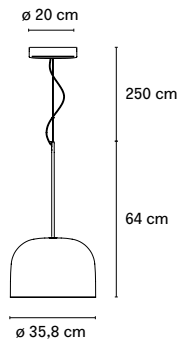

Codice Code	Materiale Material	Colore Colour	Sorgente luminosa Light source	Dimmer Dimmer	Prezzo no IVA Price VAT excluded
F439085550CRLE	Vetro, Metallo Galvanizzato Glass, Galvanized Metal	Cromo Chrome	LED 40W (2700K, CRI>90, 4500Lm)	1-10V 1-10V	1.525,00 €
F439085550NELE	Vetro, Metallo Galvanizzato Glass, Galvanized Metal	Nero lucido Glossy black	LLED 40W (2700K, CRI>90, 4500Lm)	1-10V 1-10V	1.525,00 €
F439085150OOLE	Vetro, Metallo Glass, Metal	Oro opaco Matt gold	LED 40W (2700K, CRI>90, 4500Lm)	1-10V 1-10V	1.393,00 €
F439085550RSLE	Vetro, Metallo Galvanizzato Glass, Galvanized Metal	Rame lucido Glossy copper	LED 40W (2700K, CRI>90, 4500Lm)	1-10V 1-10V	1.525,00 €



Su richiesta tecnologia  
Dali o Casambi  
Dali or Casambi  
technology on request

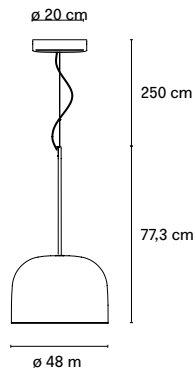

Codice Code	Materiale Material	Colore Colour	Sorgente luminosa Light source	Dimmer incluso Dimmer included	Prezzo no IVA Price VAT excluded
F439090550CRLE	Vetro, Metallo Galvanizzato Glass, Galvanized Metal	Cromo Chrome	LED 60W (2700K, CRI>90, 6600Lm)	1-10V 1-10V	2.828,00 €
F439090550NELE	Vetro, Metallo Galvanizzato Glass, Galvanized Metal	Nero lucido Glossy black	LED 60W (2700K, CRI>90, 6600Lm)	1-10V 1-10V	2.828,00 €
F439090150OOLE	Vetro, Metallo Glass, Metal	Oro opaco Matt gold	LED 60W (2700K, CRI>90, 6600Lm)	1-10V 1-10V	2.770,00 €
F439090550RSLE	Vetro, Metallo Galvanizzato Glass, Galvanized Metal	Rame lucido Glossy copper	LED 60W (2700K, CRI>90, 6600Lm)	1-10V 1-10V	2.828,00 €



Su richiesta tecnologia  
Dali o Casambi  
Dali or Casambi  
technology on request

#### KIT CASAMBI R442100K05BI00

Casambi è un dispositivo intelligente, non è necessaria una connessione Internet ma è sufficiente attivare il Bluetooth del telefono o tablet o altri dispositivi di controllo e scaricare la App gratuita grazie alla quale le lampade potranno venire accese, spente e regolate di intensità a seconda dello scenario che si desidera nel proprio ambiente.

Casambi is an intelligent device, no Internet connection is required, simply activate the Bluetooth on your phone, tablet or other control device and download the free App to turn the lamps on and off and adjust their intensity according to the scenario you want to create in your environment.

128,00 €







# FLÛTE

Franco Raggi, 1999



Un cono di vetro alloggia il riflettore in alluminio cromato, sorretto da tre aste sottili in metallo. Equilibrio e leggerezza per questa famiglia di lampade disponibili nella versione da terra e a parete per una emissione di luce indiretta e a sospensione, per una emissione di luce puntuale e diretta.

Lampada a sospensione a luce diretta dimmerabile. Diffusore in vetro borosilicato trasparente. Riflettore in alluminio cromato lucido. Supporto riflettore in metallo. Cavo di alimentazione trasparente. Rosone in materiale termoplastico cromato.

A glass cone holds the chromed aluminum reflector, supported by three slender metal rods. Equilibrium and lightness for this family of lamps available in floor and wall versions, for indirect light emission, and in a hanging version, for direct focused light.

Dimmable direct light pendant lamp. Transparent borosilicate glass diffuser. Aluminium reflector. Metal reflector support. Transparent power cable. Chrome-plated thermoplastic ceiling rose.

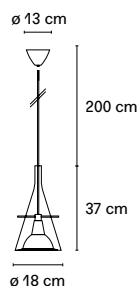

Codice Code	Materiale Material	Colore Colour	Sorgente luminosa Light source	Dimmerabile Dimmable	Prezzo no IVA Price VAT excluded
F333780150TCNE	Vetro, Metallo Glass, Metal	Trasparente, Cromo Transparent, Chrome	1x max 70W E27		467,00 €
F333780550NENE	Vetro, Metallo Galvanizzato Glass, Galvanized Metal	Trasparente, Nero lucido Transparent, Glossy black	1x max 70W E27		484,00 €
F333780550OTNE	Vetro, Metallo Galvanizzato Glass, Galvanized Metal	Trasparente, Ottone Transparent, Brass	1x max 70W E27		484,00 €



CE ENEC IP20

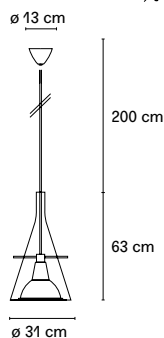

Codice Code	Materiale Material	Colore Colour	Sorgente luminosa Light source	Dimmer Dimmer	Prezzo no IVA Price VAT excluded
F333795150TCNE	Vetro, Metallo Glass, Metal	Trasparente, Cromo Transparent, Chrome	1x max 230W R7s/115		1.270,00 €



CE ENEC IP20



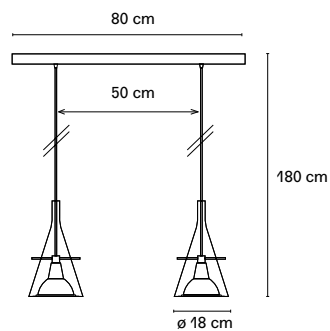

Codice Code	Materiale Material	Colore Colour	Sorgente luminosa Light source	Dimmer Dimmer	Prezzo no IVA Price VAT excluded
F333785150TCNE	Vetro, Metallo Glass, Metal	Trasparente, Cromo Transparent, Chrome	2x max 70W E27	☑	1.025,00 €

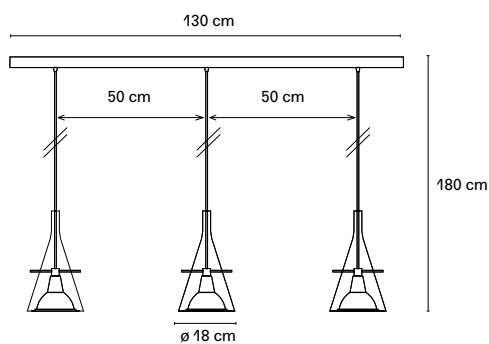

Codice Code	Materiale Material	Colore Colour	Sorgente luminosa Light source	Dimmer Dimmer	Prezzo no IVA Price VAT excluded
F333790150TCNE	Vetro, Metallo Glass, Metal	Trasparente, Cromo Transparent, Chrome	3x max 70W E27	☑	1.516,00 €





# FONTANELLA

Federico Peri, 2020



Due materiali: metallo e vetro, come nella storica tradizione di FontanaArte. Il metallo funge da corpo mentre il vetro, vero protagonista del progetto, viene sapientemente lavorato da abili artigiani in un processo di fusione fra una porzione di vetro trasparente ed una satinata dalla quale la luce si diffonde. Fontanella è formata dall'unione di due vetri: il tubo interno viene filettato, sabbiato ed infine giuntato con il vetro soffiato a forma di bolla.

Lampada sospensione a luce diffusa dimmerabile. Montatura in metallo galvanizzato. Diffusore in vetro soffiato in borisilicato. Cavo di sospensione in acciaio. Cavo di alimentazione trasparente. Rosone in metallo.

Two materials: metal and glass, in the historical tradition of FontanaArte. The metal acts as the body while the glass, the true protagonist of the project, is skilfully worked by skilled craftsmen in a process of fusion between a portion of transparent glass and a satinised portion from which light diffuses. Fontanella is formed by joining two pieces of glass: the inner tube is threaded, sandblasted and finally joined with the blown glass in the shape of a bubble.

Dimmable suspension lamp providing diffused light. Galvanised metal fitting. Borisilicate blown glass diffuser. Steel suspension cable. Transparent power cable. Metal ceiling rose.

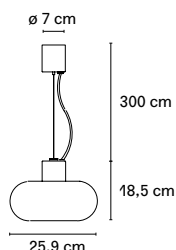

Codice Code	Materiale Material	Colore Colour	Sorgente luminosa Light source	Dimmerabile Dimmable	Prezzo no IVA Price VAT excluded
F447890550NENE	Vetro, Metallo Galvanizzato Glass, Galvanized Metal	● Nero lucido Glossy black	1x max 28W E14	☑	533,00 €
F447890550OTNE	Vetro, Metallo Galvanizzato Glass, Galvanized Metal	● Ottone satinato Satin Brass	1x max 28W E14	☑	549,00 €

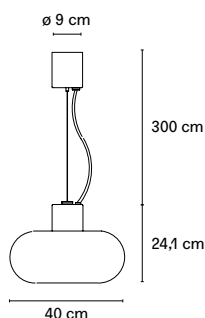

Codice Code	Materiale Material	Colore Colour	Sorgente luminosa Light source	Dimmerabile Dimmable	Prezzo no IVA Price VAT excluded
F447885550NENE	Vetro, Metallo Galvanizzato Glass, Galvanized Metal	● Nero lucido Glossy black	1x max 77W E27	☑	713,00 €
F447885550OTNE	Vetro, Metallo Galvanizzato Glass, Galvanized Metal	● Ottone satinato Satin Brass	1x max 77W E27	☑	730,00 €







# GLOBO DI LUCE

Roberto Menghi, 1968



Il vetro soffiato, nella finiture cromo e rame metallizzato, impreziosisce il paralume sferico di questa famiglia di lampade, disponibili nella versione da tavolo e, in tre diverse misure, nella versione a sospensione.

Lampada a sospensione a luce diretta dimmerabile. Diffusore in vetro soffiato metallizzato. Riflettore interno in alluminio brillantato. Cavo di sospensione in acciaio. Cavo di alimentazione trasparente. Rosone metallizzato.

Blown glass, in chrome and metallised copper finishes, embellishes the spherical shade of this family of lamps, available in a table version and, in three different sizes, in a pendant version.

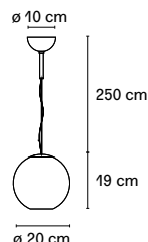
Dimmable direct light pendant lamp. Metallised blown glass diffuser. Polished aluminium internal reflector. Steel suspension cable. Transparent power cable. Metallised ceiling rose.





Codice Code	Materiale Material	Colore Colour	Sorgente luminosa Light source	Dimmerabile Dimmable	Prezzo no IVA Price VAT excluded
F364480150CRNE	Vetro, Metallo Glass, Metal	 Cromo Chrome	1x max 40W E14	<input checked="" type="checkbox"/>	443,00 €
F364480150RMNE	Vetro, Metallo Glass, Metal	 Rame Copper	1x max 40W E14	<input checked="" type="checkbox"/>	484,00 €

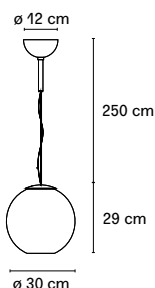

CE ENEC

IP20



Codice Code	Materiale Material	Colore Colour	Sorgente luminosa Light source	Dimmerabile Dimmable	Prezzo no IVA Price VAT excluded
F364485150CRNE	Vetro, Metallo Glass, Metal	 Cromo Chrome	1x max 60W G9	<input checked="" type="checkbox"/>	590,00 €
F364485150RMNE	Vetro, Metallo Glass, Metal	 Rame Copper	1x max 60W G9	<input checked="" type="checkbox"/>	672,00 €





CE ENEC

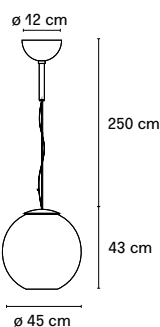

IP20



Codice Code	Materiale Material	Colore Colour	Sorgente luminosa Light source	Dimmerabile Dimmable	Prezzo no IVA Price VAT excluded
F364490150CRNE	Vetro, Metallo Glass, Metal	 Cromo Chrome	1x max 150W E27	<input checked="" type="checkbox"/>	893,00 €
F364490150RMNE	Vetro, Metallo Glass, Metal	 Rame Copper	1x max 150W E27	<input checked="" type="checkbox"/>	984,00 €



CE ENEC



IP20







# HUNA

*Historical Archive, 1965*

Da un progetto del 1965, una sospensione dalla forma senza tempo, questa lampada conferisce un'illuminazione diretta e intensa. Per un loft sofisticato dal sapore contemporaneo, per una cucina moderna e ricercata, per uno spazio conviviale domestico o pubblico.

Lampada a sospensione a luce diretta. Diffusore in metallo. Cavo di alimentazione trasparente. Cavo di sospensione in acciaio. Rosone in polimero verniciato.

From a 1965 design, a pendant with a timeless shape, this lamp provides direct and intense lighting. For a sophisticated loft with a contemporary flavour, for a modern and sophisticated kitchen, for a convivial domestic or public space.

Suspension lamp providing direct light. Metal diffuser. Transparent power cable. Steel suspension cable. Painted metal ceiling rose.

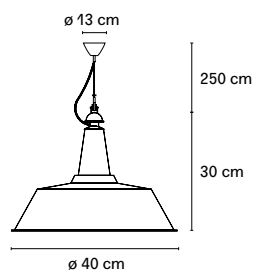

Codice Code	Materiale Material	Colore Colour	Sorgente luminosa Light source	Dimmerabile Dimmable	Prezzo no IVA Price VAT excluded
F505985200NENE	Metallo Verniciato Painted Metal	● Nero Black	1x max 116W E27	✓	262,00 €



CE ENEC IP20



# LAMPARA

*Historical Archive, 1965*

Rievoca le architetture industriali e per questo trova una perfetta collocazione sia in uno spazio domestico che in progetti di contract nell'ambito della ristorazione. Una forma sempre contemporanea per un oggetto di design senza tempo.

Lampada a sospensione a luce diretta dimmerabile. Montatura in metallo verniciato. Cavo di sospensione in acciaio. Cavo di alimentazione trasparente. Rosone in materiale termoplastico verniciato.

It is reminiscent of industrial architecture and therefore finds a perfect fit in both a domestic space and contract projects in the catering industry. An ever contemporary shape for a timeless design object.

Dimmable direct light pendant lamp. Painted metal fitting. Steel suspension cable. Transparent power cable. Painted thermoplastic ceiling rose.

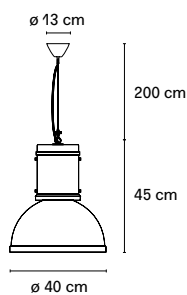

Codice Code	Materiale Material	Colore Colour	Sorgente luminosa Light source	Dimmerabile Dimmable	Prezzo no IVA Price VAT excluded
F500090200ALNE	Metallo Verniciato Painted Metal	● Alluminio Aluminum	1x max 116W E27	✓	369,00 €
F500090220BINE	Metallo Verniciato Painted Metal	○ Bianca White	1x max 116W E27	✓	488,00 €



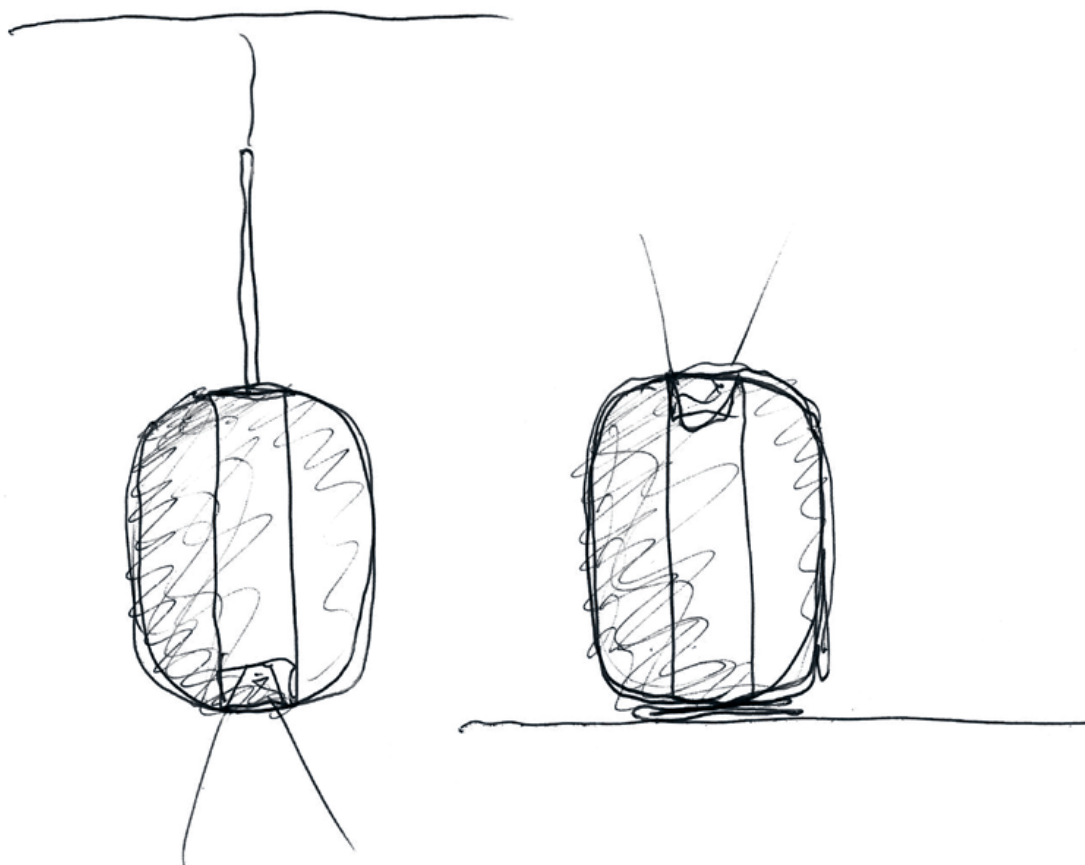



# MERIDIANO

Gabriele e Oscar Buratti, 2020



Passando tra layer opalini, colorati e trasparenti, enfatizzata dalle curvature ricercate e dalla magia dei vetri soffiati, la luce è libera di creare effetti, disegni ed atmosfere sorprendenti ed affascinanti. In Meridiano, il tubo cilindrico verticale contiene e diffonde la luce nella capsula di vetro trasparente, che ne definisce la ricercata forma ovoidale.

Lampada a sospensione a luce diffusa/diretta con doppia accensione dimmerabile parzialmente. La doppia accensione consente di illuminare separatamente la parte centrale (dimmerabile) e quella inferiore del diffusore (interruttore on-off). Montatura in metallo nichelato. Diffusore esterno in vetro soffiato. Diffusore interno in vetro pyrex verniciato internamente. Cavo di sospensione in acciaio. Cavo di alimentazione nero. Rosone in metallo verniciato.

Passing through opal, coloured and transparent layers, emphasised by the refined curves and magic of blown glass, light is free to create surprising and fascinating effects, patterns and atmospheres. In Meridiano, the vertical cylindrical tube contains and diffuses light in the transparent glass capsule, which defines its refined ovoid shape.

Ceiling light providing diffused/direct light with double switch and partially dimmable. The double switch allows the central (dimmable) and lower part of the diffuser (on-off switch) to be switched on separately. Nickel-plated metal frame. External diffuser in blown glass. Internal diffuser in internally painted Pyrex glass. Steel suspension cable. Black power cable. Painted metal ceiling rose.

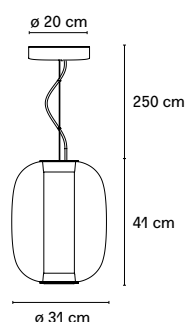

Codice Code	Materiale Material	Colore Colour	Sorgente luminosa Light source	Dimmer Dimmer	Prezzo no IVA Price VAT excluded
F44178550NFLE	Vetro, Metallo Galvanizzato Glass, Galvanized Metal	Nero, Fumè Black, Grey fumè	LED 25W* (2700K, CRI>90, 2900Lm) + LED 8W ** (2700K, 1180Lm)	<input checked="" type="checkbox"/> 1-10V* <input type="checkbox"/> **	1.500,00 €



CE IP20

Su richiesta tecnologia  
Dali o Casambi  
Dali or Casambi  
technology on request

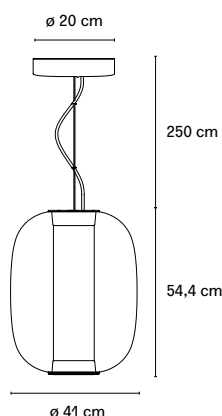

Codice Code	Materiale Material	Colore Colour	Sorgente luminosa Light source	Dimmer Dimmer	Prezzo no IVA Price VAT excluded
F441790550NFLE	Vetro, Metallo Galvanizzato Glass, Galvanized Metal	Nero, Fumè Black, Grey fumè	LED 35W* (2700K, CRI>90, 4000Lm) + LED 8W** (2700K, 1180Lm)	<input checked="" type="checkbox"/> 1-10V* <input type="checkbox"/> **	1.926,00 €



CE IP20

Su richiesta tecnologia  
Dali o Casambi  
Dali or Casambi  
technology on request









# OORT SISTEMA

Jacopo Roda, 2022



Come la nube di OORT è l'origine di milioni di nuclei di comete che con la loro scia illuminano il Firmamento, così il sistema di lampade componibile dalla quale prende il nome è l'origine di una serie infinita di soluzioni luminose.

La versione sospensione è disponibile nei modelli orizzontale e verticale, entrambi anche in composizioni multiple e di altezze diverse. Rosone per il collegamento elettrico a soffitto decentrato in finitura bianca. Alimentatore dimmerabile.

Just as the OORT cloud is the origin of millions of comet nuclei that illuminate the Firmament with their wake, so the modular lamp system from which it takes its name is the origin of an endless series of lighting solutions.

The suspension version is available in horizontal and vertical models, both also in multiple compositions and different heights. Off-centre ceiling rose for electrical connection in white finish. Dimmable ballast.

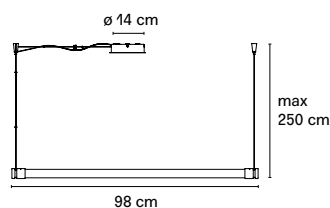

Codice Code	Materiale Material	Colore Colour	Sorgente luminosa Light source	Dimmer Dimmer	Prezzo no IVA Price VAT excluded
OORT00103	Vetro, Metallo Galvanizzato Glass, Galvanized Metal	● Nichel nero Nickel black	LED 18W (2700K, 1700Lm)	☑ 1-10V/PUSH	574,00 €



CE IP20

Su richiesta tecnologia  
DALI, Casambi e 3000K  
DALI, Casambi technology  
and 3000K on request

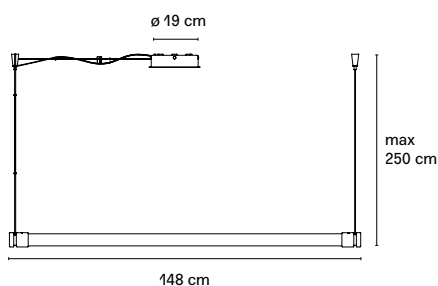

Codice Code	Materiale Material	Colore Colour	Sorgente luminosa Light source	Dimmer Dimmer	Prezzo no IVA Price VAT excluded
OORT00104	Vetro, Metallo Galvanizzato Glass, Galvanized Metal	● Nichel nero Nickel black	LED 28W (2700K, 2660Lm)	☑ 1-10V/PUSH	680,00 €



CE IP20

Su richiesta tecnologia  
DALI, Casambi e 3000K  
DALI, Casambi technology  
and 3000K on request

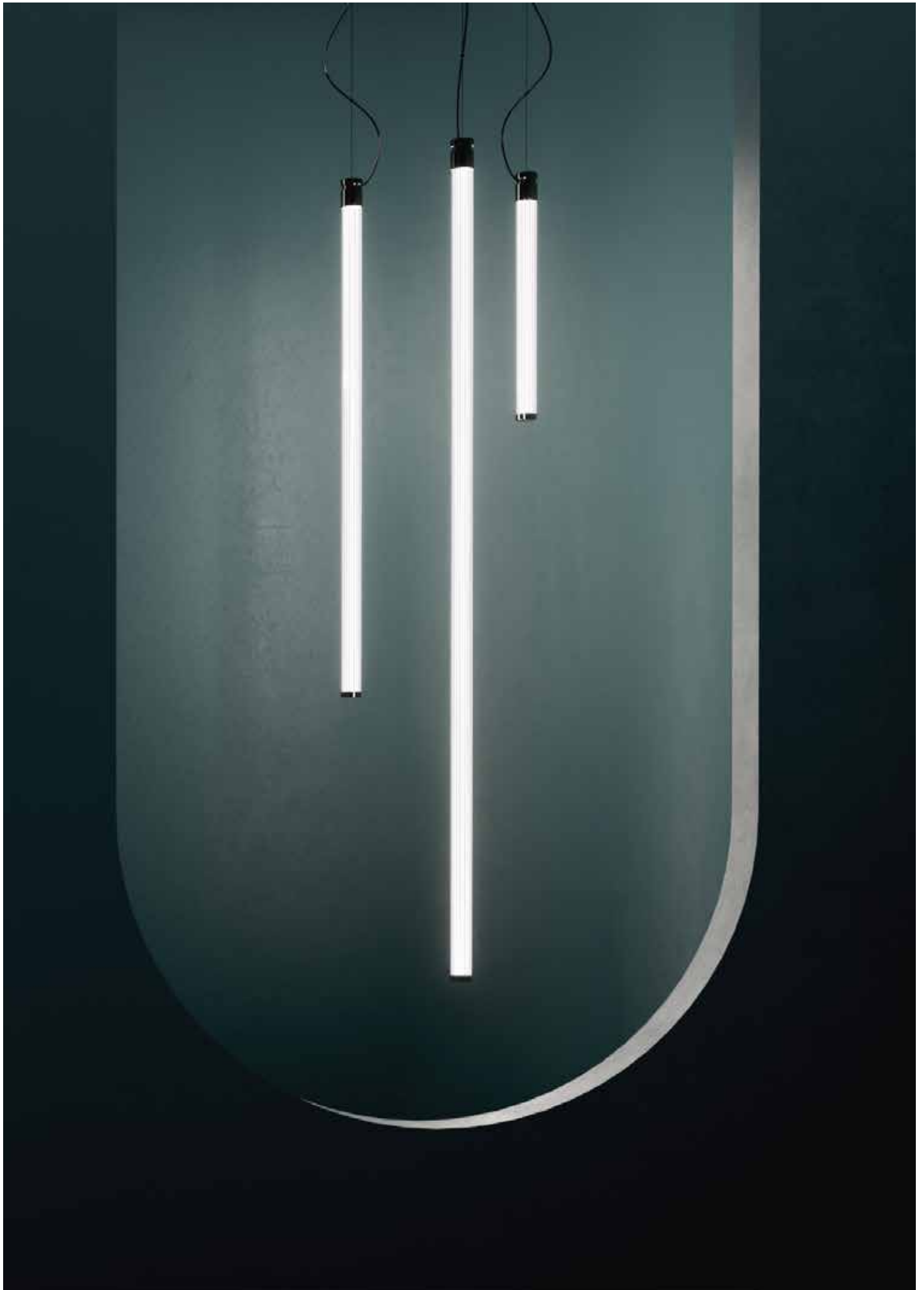

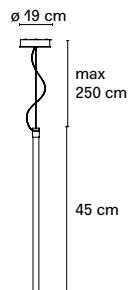

Codice Code	Materiale Material	Colore Colour	Sorgente luminosa Light source	Dimmer Dimmer	Prezzo no IVA Price VAT excluded
OORT00105	Vetro, Metallo Galvanizzato Glass, Galvanized Metal	● Nichel nero Nickel black	LED 8W (2700K, 760Lm)	✓ 1-10V/PUSH	434,00 €



Su richiesta tecnologia  
DALI, Casambi e 3000K  
DALI, Casambi technology  
and 3000K on request

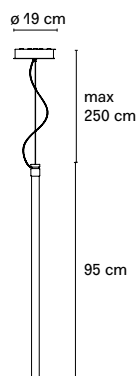

Codice Code	Materiale Material	Colore Colour	Sorgente luminosa Light source	Dimmer Dimmer	Prezzo no IVA Price VAT excluded
OORT00106	Vetro, Metallo Galvanizzato Glass, Galvanized Metal	● Nichel nero Nickel black	LED 18W (2700K, 1700Lm)	✓ 1-10V/PUSH	508,00 €



Su richiesta tecnologia  
DALI, Casambi e 3000K  
DALI, Casambi technology  
and 3000K on request

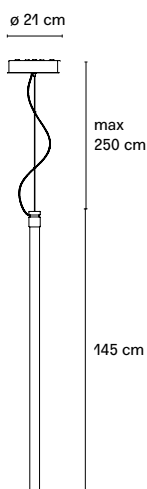

Codice Code	Materiale Material	Colore Colour	Sorgente luminosa Light source	Dimmer Dimmer	Prezzo no IVA Price VAT excluded
OORT00107	Vetro, Metallo Galvanizzato Glass, Galvanized Metal	● Nichel nero Nickel black	LED 28W (2700K, 2660Lm)	✓ DALI/PUSH	590,00 €

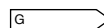

Su richiesta tecnologia  
DALI, Casambi e 3000K  
DALI, Casambi technology  
and 3000K on request



# PALLINA

FontanaArte Design Lab, 2019

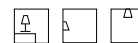

La perfezione del vetro e della sfera si uniscono nell'oggetto più essenziale della collezione, un vero e proprio must-have ideale per ogni angolo della casa. Pallina. Una, nessuna, centomila.

Lampada a sospensione a luce diffusa dimmerabile. Montatura in metallo galvanizzato con doppia tige intercambiabile. Diffusore in vetro soffiato satinato opalino. Cavo di alimentazione trasparente. Rosone in policarbonato verniciato.

The perfection of glass and sphere come together in the most essential object in the collection, a real must-have for every corner of the house. Pallina. One, none, a hundred thousand.

Suspension lamp with diffused and dimmable light. Frame made of chromed metal with double interchangeable stem. Diffuser made of opaline blown glass with satin-finish. Transparent power cable. Painted polycarbonate ceiling rose.

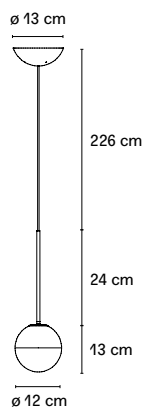

Codice Code	Materiale Material	Colore Colour	Sorgente luminosa Light source	Dimmerabile Dimmerable	Prezzo no IVA Price VAT excluded
F443080150NENE	Vetro, Metallo Galvanizzato Glass, Galvanized Metal	● Nero lucido Glossy black	1x max 6W G9	✓	307,00 €
F443080150NSNE	Vetro, Metallo Galvanizzato Glass, Galvanized Metal	● Nichel lucido Glossy nickel	1x max 6W G9	✓	307,00 €
F443080150OTNE	Vetro, Metallo Galvanizzato Glass, Galvanized Metal	● Ottone satinato Satin brass	1x max 6W G9	✓	307,00 €







# PANGEN

*Historical Archive, 1969*

Il paralume di Pangen è una cupola dalla forma fluida e minimale la cui finitura laccata, proposta in diversi colori, regala riflessi di luce sorprendenti. Disponibile in versione sospensione e plafone.

Lampada a sospensione a luce diretta dimmerabile. Diffusore superiore in metallo verniciato. Diffusore inferiore in policarbonato opalino. Cavo di alimentazione trasparente. Rosone in policarbonato cromato.

Pangen's lampshade is a dome with a fluid and minimalist shape whose lacquered finish, available in different colours, gives surprising reflections of light. Available in suspension and ceiling versions.

Suspension lamp with direct and dimmable light. Top diffuser made of painted metal. Bottom diffuser made of opaline polycarbonate. Transparent power cable. Chromed polycarbonate ceiling rose.

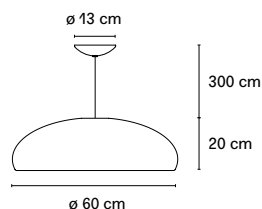

Codice Code	Materiale Material	Colore Colour	Sorgente luminosa Light source	Dimmerabile Dimmable	Prezzo no IVA Price VAT excluded
F419685350BINE	Polimero, Metallo Polymer, Metal	○ Bianco White	3x max 46W E27	✓	684,00 €
F419685350NENE	Polimero, Metallo Polymer, Metal	● Nero Black	3x max 46W E27	✓	684,00 €
F419685350RONE	Polimero, Metallo Polymer, Metal	● Rosso red	3x max 46W E27	✓	684,00 €





# PAROLA

Gae Aulenti e Piero Castiglioni, 1980



La lampada Parola unisce artigianato e industria attraverso l'uso del vetro soffiato, combinando eleganza artigianale e precisione industriale in un design raffinato.

Lampada a sospensione a luce diffusa dimmerabile. Diffusore in vetro soffiato lucido colorato in pasta. Cavo di alimentazione trasparente. Rosone in policarbonato verniciato.

The Parola lamp combines craftsmanship and industry through the use of blown glass, combining handcrafted elegance and industrial precision in a refined design.

Suspension lamp with diffused and dimmable light. Diffuser made of glossy and coloured blown glass paste. Transparent power cable. Painted polycarbonate ceiling rose.

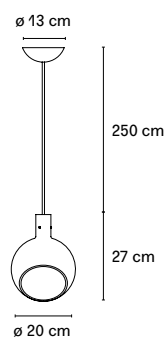

Codice Code	Materiale Material	Colore Colour	Sorgente luminosa Light source	Dimmerabile Dimmable	Prezzo no IVA Price VAT excluded
F428485100AMNE	Vetro Glass	● Ambra Amber	1x max 3,5W G9	✓	410,00 €
F428485100BINE	Vetro Glass	○ Bianco White	1x max 3,5W G9	✓	410,00 €



CE ENEC Classe II IP20

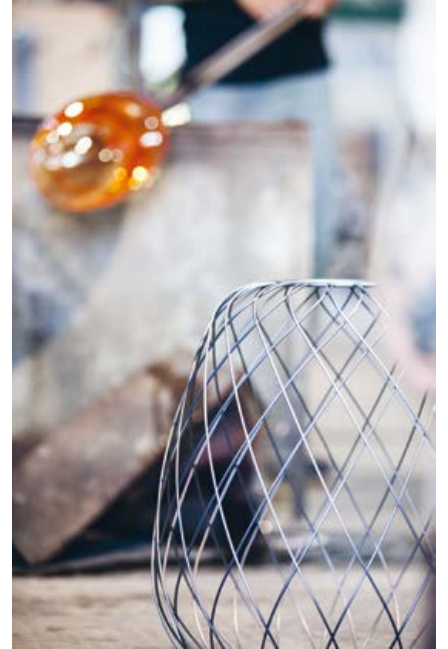



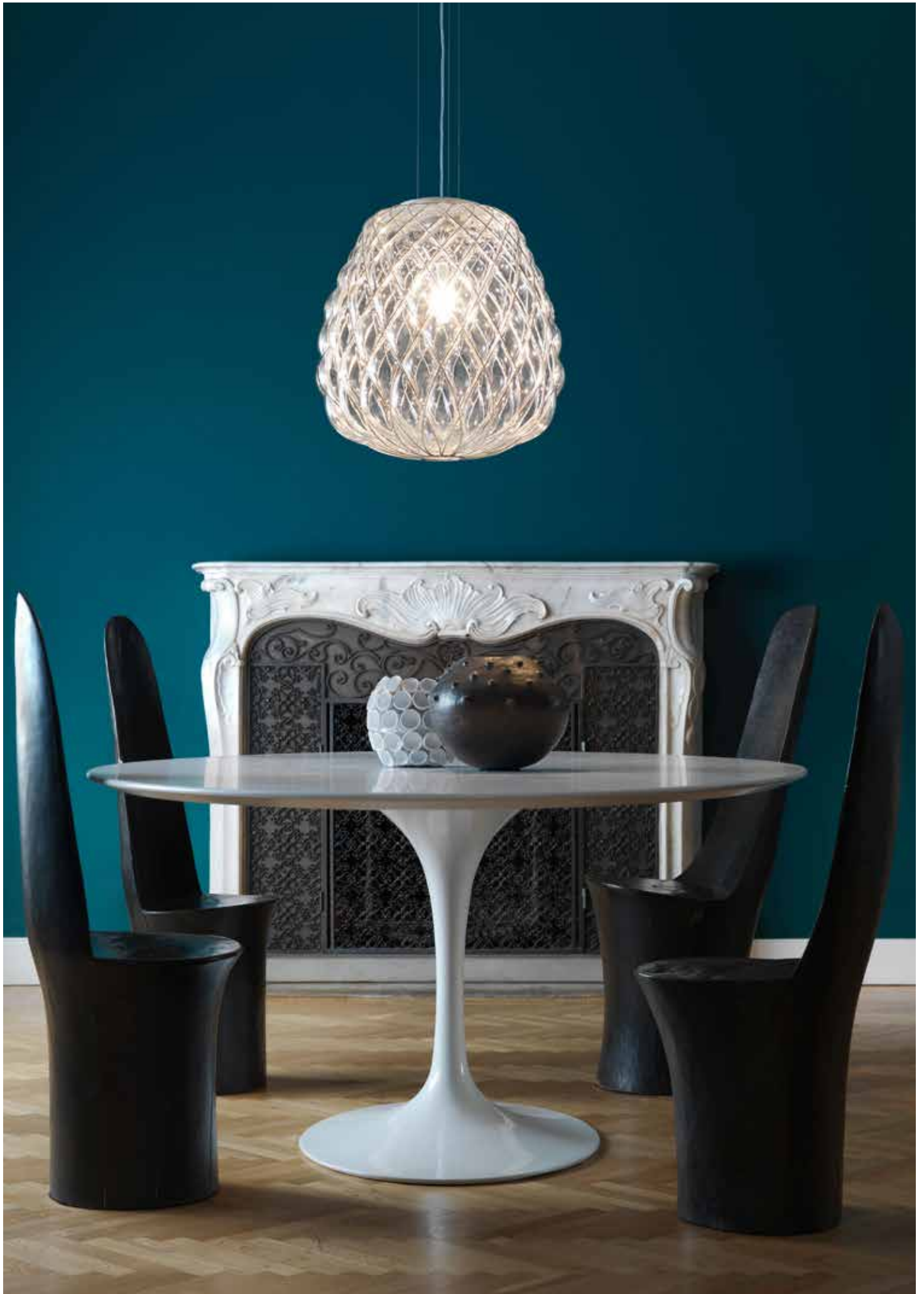

# PINECONE

Paola Navone, 2016



Pinecone è una lampada da sospensione e da appoggio con un diffusore realizzato tramite l'antica tecnica del vetro soffiato ingabbiato. Il maestro vetraio soffia la bolla vitrea in una gabbia metallica, che ne contiene parzialmente l'espansione, creando un effetto di tensione tra il vetro e la gabbia. Quest'ultima viene ulteriormente valorizzata da un trattamento galvanico che la rende lucida e brillante.

Lampada a sospensione a luce diffusa dimmerabile. Diffusore in vetro soffiato opalino acidato ingabbiato o trasparente. Gabbia e base in metallo galvanizzato. Cavi di sospensione in acciaio. Cavo di alimentazione trasparente.

Pinecone is a pendant and floor lamp with a diffuser made using the ancient technique of caged blown glass. The master glassmaker blows the glass bubble into a metal cage, which partially contains its expansion, creating a tension effect between the glass and the cage. The latter is further enhanced by a galvanic treatment that makes it shiny and brilliant.

Suspension lamp providing diffused dimmable light. Diffuser in blown opaline acid-etched or transparent glass. Galvanised metal cage and base. Steel suspension cables. Transparent power cable.

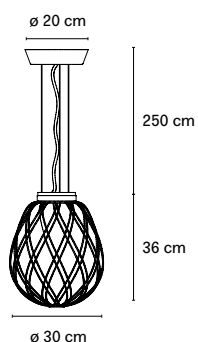

Codice Code	Materiale Material	Colore Colour	Sorgente luminosa Light source	Dimmer Dimmer	Prezzo no IVA Price VAT excluded
F436385550TCNE	Vetro, Metallo Galvanizzato Glass, Galvanized Metal	Trasparente, Cromo Transparent, Chrome	1x max 116W E27	☑	1.467,00 €
F436385550CBNE	Vetro, Metallo Galvanizzato Glass, Galvanized Metal	Bianco, Cromo White, Chrome	1x max 116W E27	☑	1.467,00 €
F436385575TONE	Vetro, Metallo Galvanizzato Glass, Galvanized Metal	Trasparente, Oro Transparent, Gold	1x max 116W E27	☑	1.549,00 €
F436385575OBNE	Vetro, Metallo Galvanizzato Glass, Galvanized Metal	Bianco, Oro White, Gold	1x max 116W E27	☑	1.549,00 €

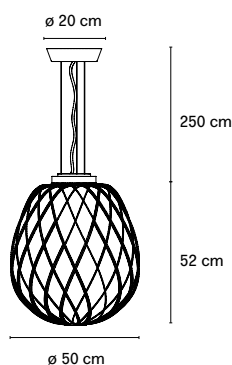

Codice Code	Materiale Material	Colore Colour	Sorgente luminosa Light source	Dimmer Dimmer	Prezzo no IVA Price VAT excluded
F433990550TCNE	Vetro, Metallo Galvanizzato Glass, Galvanized Metal	Trasparente, Cromo Transparent, Chrome	1x max 116W E27	☑	1.828,00 €
F433990550CBNE	Vetro, Metallo Galvanizzato Glass, Galvanized Metal	Bianco, Cromo White, Chrome	1x max 116W E27	☑	1.828,00 €
F433990575TONE	Vetro, Metallo Galvanizzato Glass, Galvanized Metal	Trasparente, Oro Transparent, Gold	1x max 116W E27	☑	2.131,00 €
F433990575OBNE	Vetro, Metallo Galvanizzato Glass, Galvanized Metal	Bianco, Oro White, Gold	1x max 116W E27	☑	2.131,00 €







# SCINTILLA

*Livio e Piero Castiglioni, 1972*





Il sistema Scintilla ha rappresentato una novità assoluta, mettendo insieme il segno essenziale e versatile di una lampada decorativa e una capacità illuminante paragonabile a un sistema tecnico.

Lampada a sospensione a luce diffusa dimmerabile. Montatura in metallo cromato. La lampada viene fornita con due differenti diffusori in vetro borosilicato trasparente e sabbato e un distanziatore per connessioni elettriche. E' possibile acquistare separatamente un riflettore in alluminio anodizzato che consente di produrre luce indiretta.

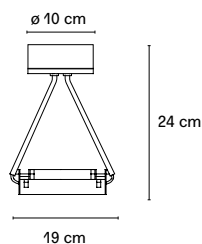
The absolutely novel Scintilla system combines the essential versatility of a decorative lamp and a lighting capacity comparable to a technical system.

Suspension lamp with diffused and dimmable light. Chromed metal frame. The lamp is supplied with two different diffusers made of transparent and sandblasted borosilicate glass and a spacer for electrical connentions. Available separately a reflector made of anodized aluminum, for indirect beam.



Codice Code	Materiale Material	Colore Colour	Sorgente luminosa Light source	Dimmerabile Dimmable	Prezzo no IVA Price VAT excluded
FS30090250CRNE	Vetro, Metallo Glass, Metall	 Cromo Chrome	1x max 230W R7s/80		266,00 €
FS30090250NSNE	Vetro, Metallo Glass, Metall	 Nichel satinato Satin nickel	1x max 230W R7s/80		266,00 €



Codice Code	Materiale Material	Colore Colour	Descrizione Description	Prezzo no IVA Price VAT excluded
RS30000M02AL00	Metallo Metall	 Alluminio Aluminum	Riflettore per FS30090250..NE, Reflector for FS30090250..NE	41,00 €



# SETAREH

Francesco Librizzi, 2017



La lampada è composta da una sfera magicamente sospesa all'interno di una struttura metallica sottile. Un gioco di masse e di traiettorie circolari genera un disegno bilanciato di dinamiche gravitazionali. La luce emanata dalla sfera si diffonde sullo spazio circostante e irraggia il telaio. I riflessi del metallo rendono visibile il campo luminoso, lo spazio influenzato dalla luce, la sua aura.

Lampada a sospensione a luce diffusa dimmerabile. Montatura in metallo galvanizzato. Diffusore sferico in vetro soffiato satinato opalino e diffusore superiore scampanato verniciato internamente e satinato esternamente. Cavo di sospensione in acciaio. Cavo di alimentazione nero.

The lamp consists of a sphere magically suspended within a slender metal structure. An interplay of masses and circular trajectories generates a balanced pattern of gravitational dynamics. The light emanating from the sphere spreads over the surrounding space and irradiates the frame. The reflections of the metal make the light field visible, the space influenced by the light, its aura.

Suspension lamp with diffused and dimmable light. Galvanized metal frame. Diffuser made of opalyne blown glass with satin-finish. Steel suspension cable. Black power cable. Painted metal ceiling rose.

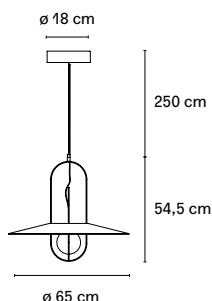

Codice Code	Materiale Material	Colore Colour	Sorgente luminosa Light source	Dimmer Dimmer	Prezzo no IVA Price VAT excluded
F438G85550NBLE	Vetro, Metallo Galvanizzato Glass, Galvanized Metal	● Nero lucido, Bianco Glossy black, White	LED 12W (2700K, CRI>80, 1550Lm)	☑ 1-10V/PUSH	984,00 €
F438G85550OBLE	Vetro, Metallo Galvanizzato Glass, Galvanized Metal	● Oro lucido, Bianco Glossy gold, White	LED 12W (2700K, CRI>80, 1550Lm)	☑ 1-10V/PUSH	984,00 €



Con diffusore in vetro  
With glass diffuser

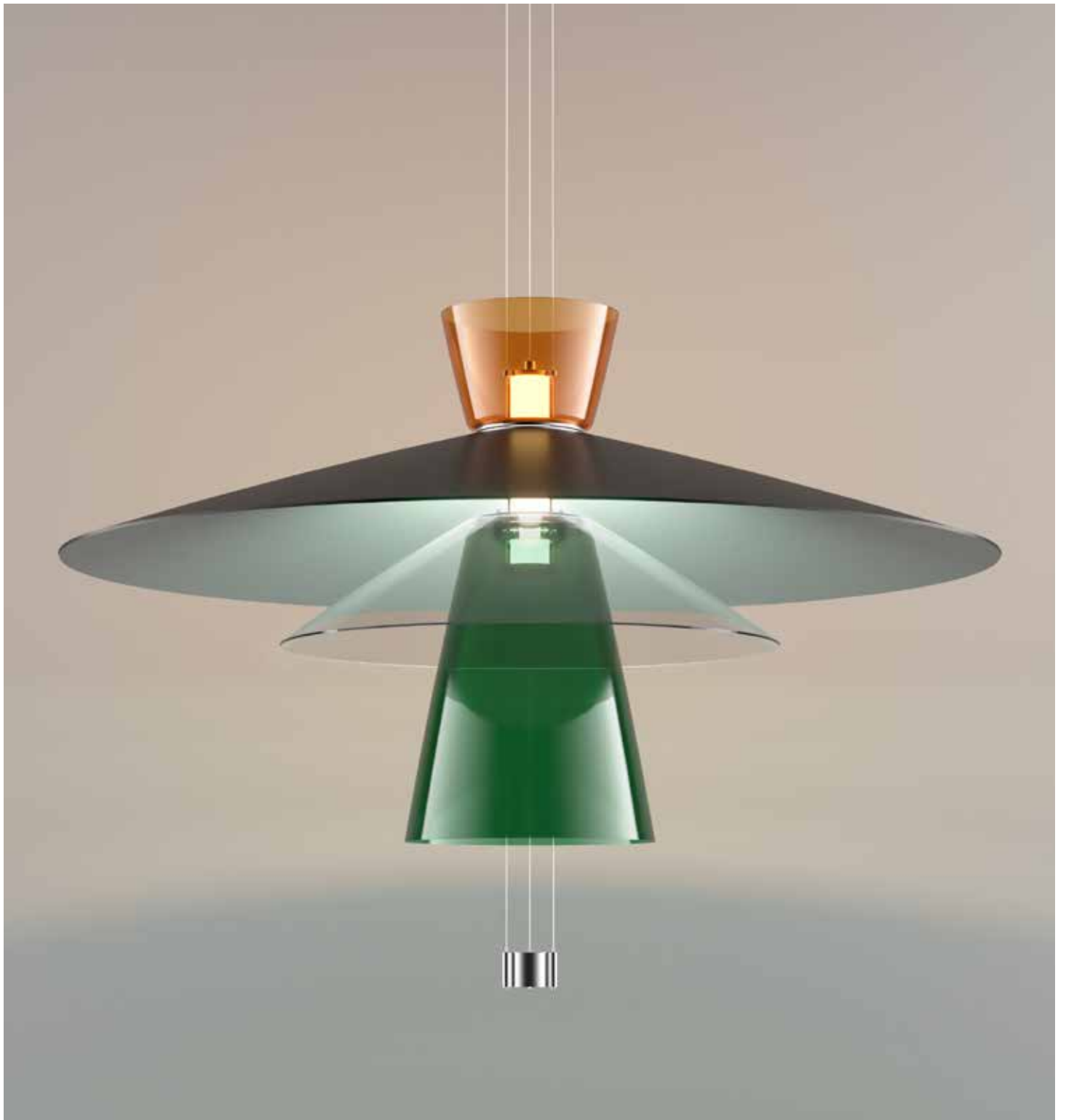

# THALEA







Paolo Rizzato & Francesco Librizzi, 2023

Thalea, creata da Paolo Rizzato e Francesco Librizzi, è una serie di paralumi in vetro colorato e alluminio. Grazie a un giunto innovativo, offre configurazioni ispirate all'arte rinascimentale. Con due sorgenti luminose, combina design e funzionalità, riflettendo lo stile di FontanaArte.

Lampada a sospensione con luce diretta e indiretta, struttura in alluminio e diffusori in vetro colorato o alluminio. Disponibile in 4 forme di vetro e 1 in alluminio nero. Due fonti luminose: luce diffusa e spot, LED integrato e dimmerabile, regolabile in altezza.











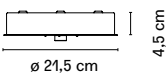

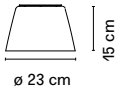





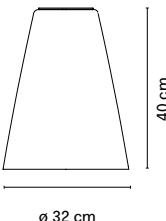

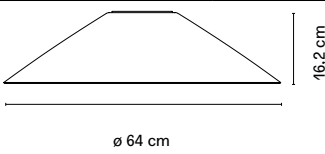

Thalea, created by Paolo Rizzato and Francesco Librizzi, is a series of coloured glass and aluminium lampshades. Thanks to an innovative joint, it offers configurations inspired by Renaissance art. With two light sources, it combines design and functionality, reflecting FontanaArte's style.

Suspension lamp with direct and indirect light, aluminium frame and coloured glass or aluminium diffusers. Available in 4 glass shapes and 1 in black aluminium. Two light sources: diffused and spot light, integrated and dimmable LED, height adjustable.

Codice Code	Descrizione Description	Colore Colour	Sorgente luminosa Light source	Dimmer incluso Dimmer included	Prezzo no IVA Price VAT excluded
THM44841E200AL	Sorgente luminosa con 1 ghiera per 2 diffusori Light source with 1 fixing ring for 2 diffusers	 Alluminio Aluminum	LED 20W (2700K, CRI>90, 2400Lm)	 DALI DALI	713,00 €
THM44842E200AL	Sorgente luminosa con 2 ghiera per 3 o più diffusori Light source with 2 fixing rings for 3 or more diffusers	 Alluminio Aluminum	LED 20W (2700K, CRI>90, 2400Lm)	 DALI DALI	930,00 €
THS44841E200AL	Spot	 Alluminio Aluminum	LED 8W (2700K, CRI 90, 1000Lm)	 DALI DALI	320,00 €

LED integrato  
Integrated LED

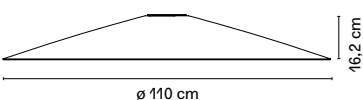

	Codice Code	Descrizione Description	Colore Colour	Prezzo no IVA Price VAT excluded
	THR44841E210NB	Rosone Ceiling	 Nero Black	246,00 €
	THV448410150AM	Diffusore in vetro Glass diffuser	 Ambra Amber	393,00 €
	THV448410150RO	Diffusore in vetro Glass diffuser	 Rosso Red	393,00 €
	THV448410150VE	Diffusore in vetro Glass diffuser	 Verde Green	393,00 €
	THV448410150BL	Diffusore in vetro Glass diffuser	 Blu Blue	393,00 €
	THV448410150TR	Diffusore in vetro Glass diffuser	 Trasparente Transparent	303,00 €
	THV448420150AM	Diffusore in vetro Glass diffuser	 Ambra Amber	664,00 €
	THV448420150RO	Diffusore in vetro Glass diffuser	 Rosso Red	664,00 €
	THV448420150VE	Diffusore in vetro Glass diffuser	 Verde Green	664,00 €
	THV448420150BL	Diffusore in vetro Glass diffuser	 Blu Blue	664,00 €
	THV448420150TR	Diffusore in vetro Glass diffuser	 Trasparente Transparent	508,00 €
	THV448430150AM	Diffusore in vetro Glass diffuser	 Ambra Amber	1.025,00 €
	THV448430150RO	Diffusore in vetro Glass diffuser	 Rosso Red	1.025,00 €
	THV448430150VE	Diffusore in vetro Glass diffuser	 Verde Green	1.025,00 €
	THV448430150BL	Diffusore in vetro Glass diffuser	 Blu Blue	1.025,00 €
	THV448430150TR	Diffusore in vetro Glass diffuser	 Trasparente Transparent	844,00 €
	THP4484200NEBI	Paralume in metallo Metal diffuser	 Nero Black	943,00 €

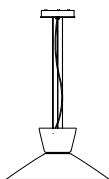

**THR44841E210NB**  
rosone / ceiling  
+  
**THM44841E200AL**  
corpo luce lineare / linear light body  
con 1 ghiera / with 1 fixing ring  
+  
**THV448410150AM**  
diffusore in vetro / glass diffuser  
d.23  
●  
+  
**THV448430150RO**  
diffusore in vetro / glass diffuser  
d.64 cm  
●

**Prezzo no IVA**  
**Price VAT excluded**

2.377,00 €



**THR44841E210NB**  
rosone / ceiling  
+  
**THM44841E200AL**  
corpo luce lineare / linear light body  
con 1 ghiera / with 1 fixing ring  
+  
**THV448410150RO**  
diffusore in vetro / glass diffuser  
d.23  
●  
+  
**THV448420150AM**  
diffusore in vetro / glass diffuser  
d.32 cm  
●

**Prezzo no IVA**  
**Price VAT excluded**

2.016,00 €

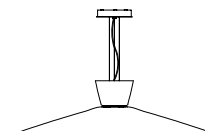

**THR44841E210NB**  
rosone / ceiling  
+  
**THM44841E200AL**  
corpo luce lineare / linear light body  
con 1 ghiera / with 1 fixing ring  
+  
**THV448410150RO**  
diffusore in vetro / glass diffuser  
d.23  
●  
+  
**THP4484200NEBI**  
diffusore in metallo / metal diffuser  
●

**Prezzo no IVA**  
**Price VAT excluded**

2.295,00 €

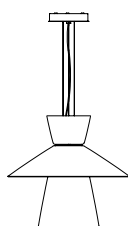

**THR44841E210NB**  
rosone / ceiling  
+  
**THM44842E200AL**  
corpo luce lineare / linear light body  
con 2 ghiera / with 2 fixing rings  
+  
**THV448410150AM**  
diffusore in vetro / glass diffuser  
d.23  
●  
+  
**THV448430150RO**  
diffusore in vetro / glass diffuser  
d.64 cm  
●  
+  
**THV448420150TR**  
diffusore in vetro / glass diffuser  
d.32 cm  
○

**Prezzo no IVA**  
**Price VAT excluded**

3.258,00 €

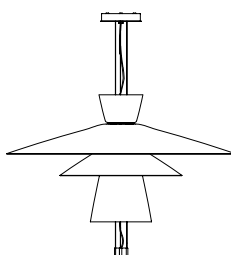

**THR44841E210NB**  
rosone / ceiling  
+  
**THM44842E200AL**  
corpo luce lineare / linear light body  
con 2 ghiera / with 2 fixing rings  
+  
**THV448410150RO**  
diffusore in vetro / glass diffuser  
d.23  
●  
+  
**THP4484200NEBI**  
diffusore in metallo / metal diffuser  
●  
+  
**THV448430150AM**  
diffusore in vetro / glass diffuser  
d.64 cm  
●  
+  
**THV448420150TR**  
diffusore in vetro / glass diffuser  
d.32 cm  
○  
+  
**THS44841E200AL**  
spot  
○

**Prezzo no IVA**  
**Price VAT excluded**

4.521,00 €

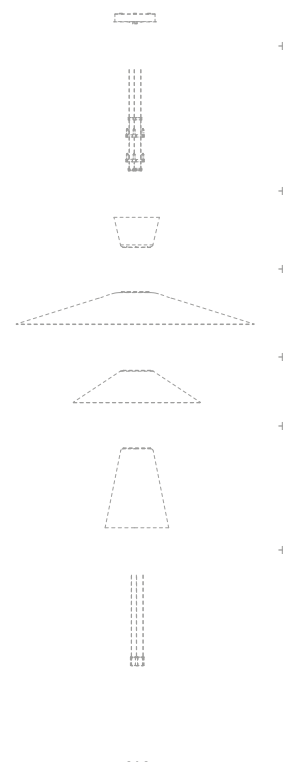

Crea la tua composizione  
consultando la tabella dei  
componenti.

Create your own composition  
by consulting the table of  
components.

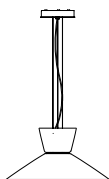

**THR44841E210NB**  
rosone / ceiling  
+  
**THM44841E200AL**  
corpo luce lineare / linear light body  
con 1 ghiera / with 1 fixing ring  
+  
**THV448410150BL**  
diffusore in vetro / glass diffuser  
d.23  
●  
+  
**THV448430150VE**  
diffusore in vetro / glass diffuser  
d.64 cm  
●

Prezzo no IVA  
Price VAT excluded

2.377,00 €



**THR44841E210NB**  
rosone / ceiling  
+  
**THM44841E200AL**  
corpo luce lineare / linear light body  
con 1 ghiera / with 1 fixing ring  
+  
**THV448410150VE**  
diffusore in vetro / glass diffuser  
d.23  
●  
+  
**THV448420150BL**  
diffusore in vetro / glass diffuser  
d.32 cm  
●

Prezzo no IVA  
Price VAT excluded

2.016,00 €

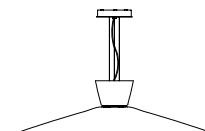

**THR44841E210NB**  
rosone / ceiling  
+  
**THM44841E200AL**  
corpo luce lineare / linear light body  
con 1 ghiera / with 1 fixing ring  
+  
**THV448410150VE**  
diffusore in vetro / glass diffuser  
d.23  
●  
+  
**THP4484200NEBI**  
diffusore in metallo / metal diffuser  
●

Prezzo no IVA  
Price VAT excluded

2.295,00 €

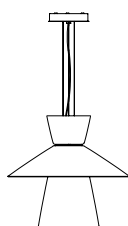

**THR44841E210NB**  
rosone / ceiling  
+  
**THM44842E200AL**  
corpo luce lineare / linear light body  
con 2 ghiera / with 2 fixing rings  
+  
**THV448410150VE**  
diffusore in vetro / glass diffuser  
d.23  
●  
+  
**THV448430150BL**  
diffusore in vetro / glass diffuser  
d.64 cm  
●  
+  
**THV448420150TR**  
diffusore in vetro / glass diffuser  
d.32 cm  
○

Prezzo no IVA  
Price VAT excluded

3.258,00 €

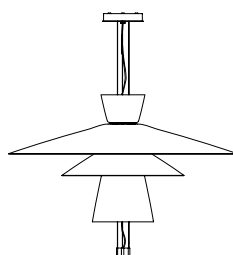

**THR44841E210NB**  
rosone / ceiling  
+  
**THM44842E200AL**  
corpo luce lineare / linear light body  
con 2 ghiera / with 2 fixing rings  
+  
**THV448410150VE**  
diffusore in vetro / glass diffuser  
d.23  
●  
+  
**THP4484200NEBI**  
diffusore in metallo / metal diffuser  
●  
+  
**THV448430150TR**  
diffusore in vetro / glass diffuser  
d.64 cm  
○  
+  
**THV448420150BL**  
diffusore in vetro / glass diffuser  
d.32 cm  
●  
+  
**THS44841E200AL**  
spot

Prezzo no IVA  
Price VAT excluded

4.521,00 €

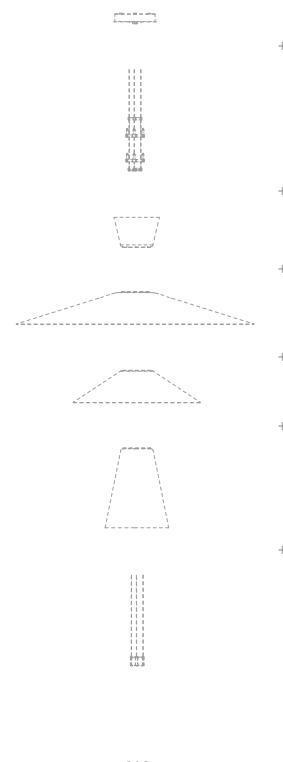

Crea la tua composizione  
consultando la tabella dei  
componenti.

Create your own composition  
by consulting the table of  
components.



## ARREDO E VASI / FURNITURE AND VASES

CARTOCCIO	p. 244
CARTOCCIO Q	p. 247
TAVOLINO FONTANA	p. 249
VASO FONTANA	p. 251
TAVOLINO 1932	p. 253
TAVOLO CON RUOTE	p. 256
TAVOLO TESO	p. 260
CONSOLLE TESO	p. 263
LIBRERIA / BOOKSHELF TESO	p. 266
TOUR	p. 268

# FONTANA ARTE



**LAMPADE, RIVESTIMENTI, MOBILI, VETRATE, TUTTE LE  
LAVORAZIONI NOBILI DEL VETRO E DEL CRISTALLO**

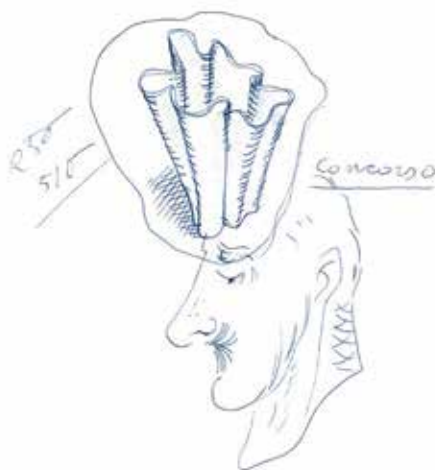



# CARTOCCIO

*Pietro Chiesa, 1932*

Straordinari vasi progettati da Pietro Chiesa nel 1932 la cui lavorazione manuale rende ogni vaso un pezzo unico.

L'unicità di ogni vaso rispecchia l'abilità e la maestria del design italiano, rendendoli icone dello stile FontanaArte.

Vaso in vetro naturale satinato e trasparente. Ricavato dalla piegatura a caldo di una lastra di vetro.

Extraordinary vases designed by Pietro Chiesa in 1932, whose manual production makes each one unique.

The uniqueness of each vase reflects the skill and craftsmanship of Italian design, making them icons of the FontanaArte style.

Satin-finished and transparent natural glass vase. Produced by hot-bending a sheet of glass.



Codice Code	Materiale Material	Colore Colour	Prezzo no IVA Price VAT excluded
F2910VA100OP10	Vetro Glass	○ Naturale Sabbiato Natural Sandblasted	557,00 €

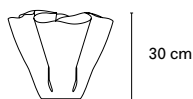

Codice Code	Materiale Material	Colore Colour	Prezzo no IVA Price VAT excluded
F2920VA100TR20	Vetro Glass	○ Naturale Sabbiato Natural Sandblasted	623,00 €





# CARTOCCIO Q

*Pietro Chiesa, 1932*

I vasi Cartoccio Q, progettati da Pietro Chiesa nel 1932 per FontanaArte, sono veri e propri capolavori di artigianato. Le forme morbide e avvolgenti ricordano un foglio di carta delicatamente modellato, conferendo un'eleganza senza tempo a questi straordinari oggetti d'arredo.

Vaso in vetro naturale satinato. Ricavato dalla piegatura a caldo di una lastra di vetro.

The Cartoccio Q vases, designed by Pietro Chiesa in 1932 for FontanaArte, are true masterpieces of craftsmanship. The soft, enveloping shapes are reminiscent of a delicately modelled sheet of paper, lending a timeless elegance to these extraordinary furnishing objects.

Vase made of natural satin glass. Made from hot folding of a sheet of glass.

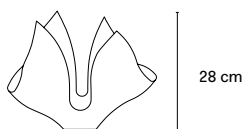

Codice Code	Materiale Material	Colore Colour	Prezzo no IVA Price VAT excluded
F3010VA100TR10	Vetro Glass	 Trasparente Transparent	451,00 €

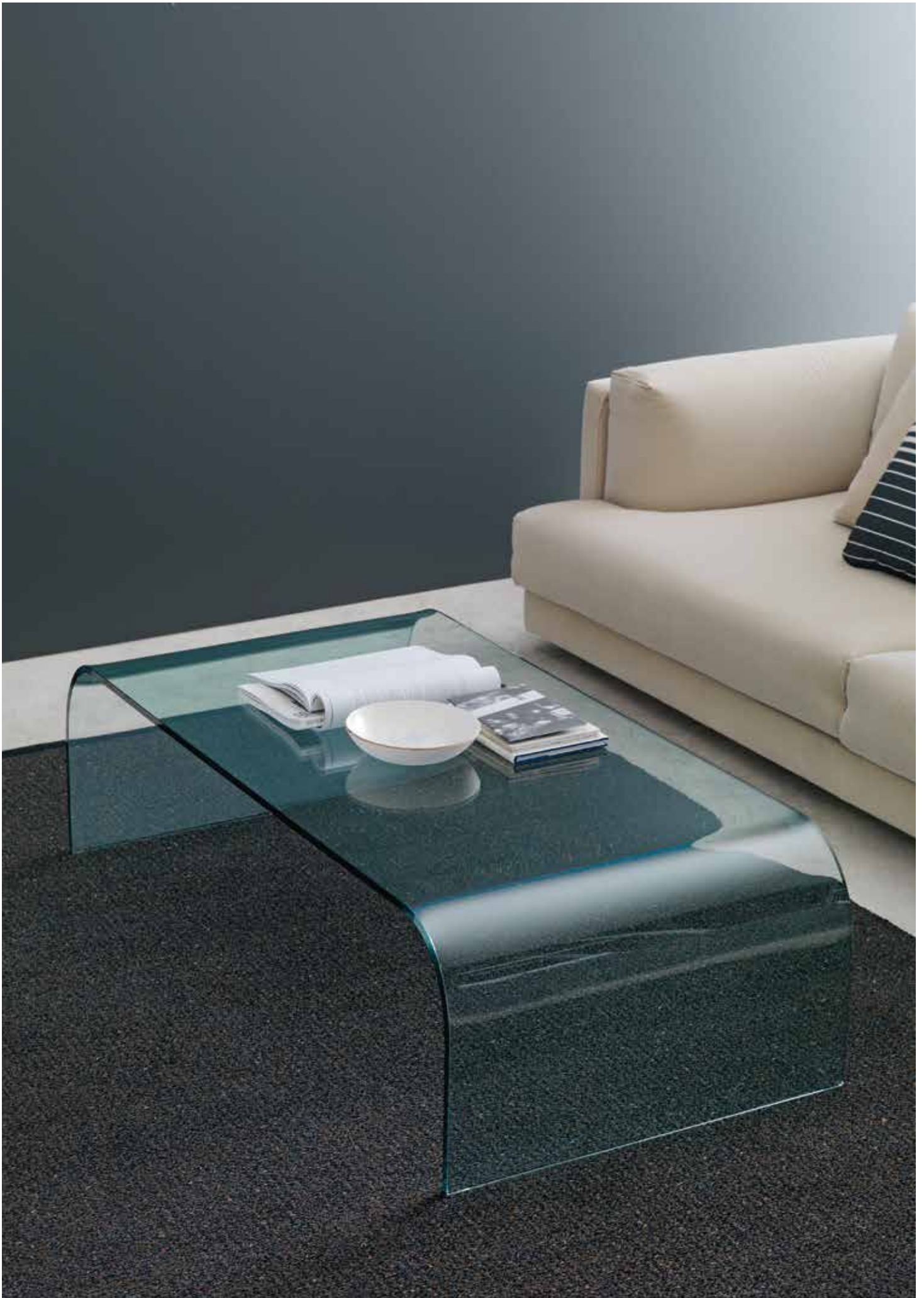



# FONTANA

*Pietro Chiesa, 1932*

Firmato da Pietro Chiesa, rappresenta per l'epoca un pezzo straordinario per essenzialità ed eleganza. È un tavolino ricavato dalla doppia curvatura di una unica lastra di grosso spessore (15 mm).

Tavolo basso in vetro float, curvato e molato

Designed by Pietro Chiesa, it was an extraordinary piece of essentiality and elegance. This coffee table is made from a double curved single piece of thick glass (15 mm).

Coffee table made of curved and ground float-glass.

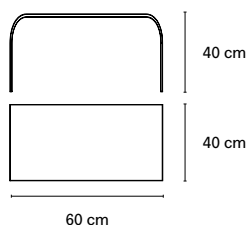

Codice Code	Materiale Material	Colore Colour	Prezzo no IVA Price VAT excluded
F2600TB100TR00	Vetro Glass	○ Trasparente Transparent	1.066,00 €

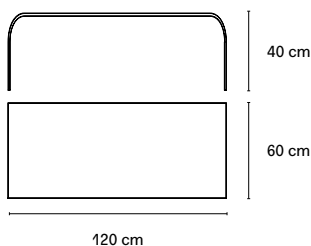

Codice Code	Materiale Material	Colore Colour	Prezzo no IVA Price VAT excluded
F2610TB100TR10	Vetro Glass	○ Trasparente Transparent	1.516,00 €

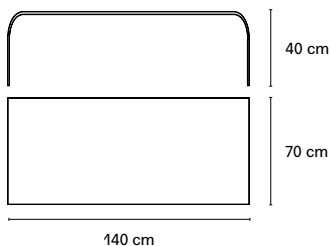

Codice Code	Materiale Material	Colore Colour	Prezzo no IVA Price VAT excluded
F2620TB100TR20	Vetro Glass	○ Trasparente Transparent	1.844,00 €



# FONTANA

FontanaArte Design Lab, 2023



Vaso artistico soffiato a bocca che si ispira all'iconica abat-jour di FontanaArte, modello 1853 disegnato da Max Ingrand nel 1954, di cui è la fedele miniatura. FONTANA è un prezioso oggetto in vetro acidato bianco latte, che decora l'ambiente con elegante semplicità ed è indicato come inedito portafiori, per creare un'atmosfera intima come portacandela tealight o celare un profumatore di ambienti.

Vaso in vetro soffiato bianco latte.

An artistic hand-blown glass vase inspired by the iconic FontanaArte abat-jour, model 1853 designed by Max Ingrand in 1954, of which it is a faithful miniature replica. FONTANA is a precious object in milky white frosted glass that decorates the space with elegant simplicity and is suitable as a unique flower vase, for creating an intimate atmosphere as a tealight candle holder or concealing an air freshener.

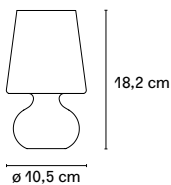
Vase of blown glass with satin-finish.



Codice Code	Materiale Material	Colore Colour	Descrizione Description	Prezzo no IVA Price VAT excluded
F1800VA100BO00	Vetro Glass	 Bianco White	Vaso singolo Single vase	78,00 €
F1900VA100BO00	Vetro Glass	 Bianco White	Vaso confezione da 4 pezzi Vase pack of 4 pieces	295,00 €



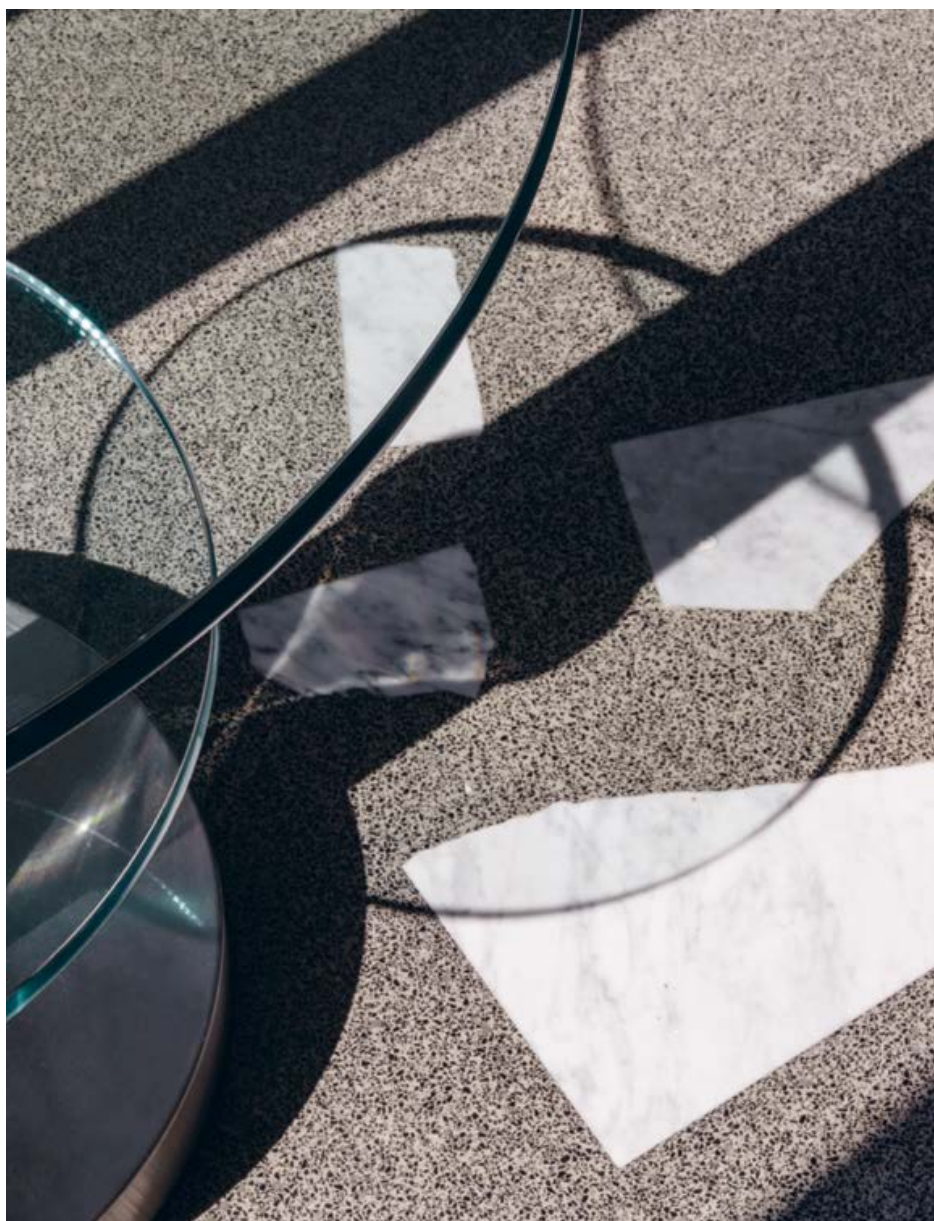





# 1932

*Gio Ponti, 1932*

Questo tavolino, che porta la firma di Gio Ponti, è composto da due dischi in vetro float dello spessore di 15 mm. La struttura è in ottone nichelato e spazzolato.

Tavolo basso con due dischi in vetro float.

This coffee table was designed by Gio Ponti and is made from two discs in float glass, 15 mm thick. The structure is in brushed nickel-plated brass.

Coffee table with two disc made of float-glass.

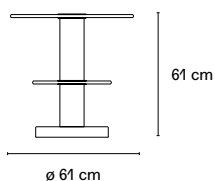

Codice Code	Materiale Material	Colore Colour	Prezzo no IVA Price VAT excluded
F2710TB150TR10	Vetro, Metallo Glass, Metal	 Trasparente, Nichel Transparent, Nickel	1.967,00 €







# TAVOLO CON RUOTE

*Gae Aulenti, 1980*

Nel progetto di Tavolo con Ruote il piano di legno del carrello industriale viene sostituito con una spessa lastra in vetro molato -simbolo della storia produttiva dell'azienda - a cui vengono fissate le rotelle industriali a movimento libero. E' così che la sostituzione di un semplice elemento trasforma la natura dell'oggetto e la sua destinazione d'uso.

Tavolino con piano in vetro flottante molato. Ruote industriali con staffe in metallo verniciato.

This wheeled table replaces the factory trolley's wooden shelf with a chunky sheet of beveled glass - a tribute to the company's production history - and fits free-rolling industrial wheels. The nature of the object and its intended use are transformed by replacing just one simple part.

Coffee table with ground float-glass top. Industrial wheels with painted metal bracket

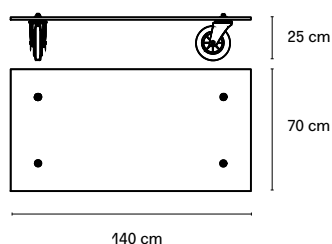

Codice Code	Materiale Material	Colore Colour	Prezzo no IVA Price VAT excluded
F1000TB150TR00	Vetro, Metallo Glass, Metal	 Trasparente, Nero Transparent, Black	1.131,00 €

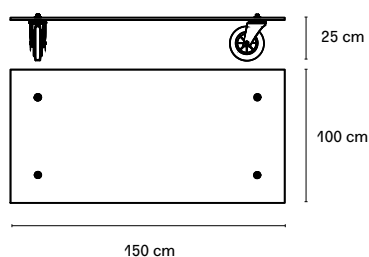

Codice Code	Materiale Material	Colore Colour	Prezzo no IVA Price VAT excluded
F1010TB150TR10	Vetro, Metallo Glass, Metal	 Trasparente, Nero Transparent, Black	1.303,00 €

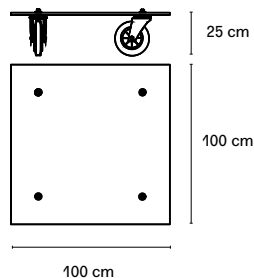

Codice Code	Materiale Material	Colore Colour	Prezzo no IVA Price VAT excluded
F1110TB150TR00	Vetro, Metallo Glass, Metal	 Trasparente, Nero Transparent, Black	1.131,00 €

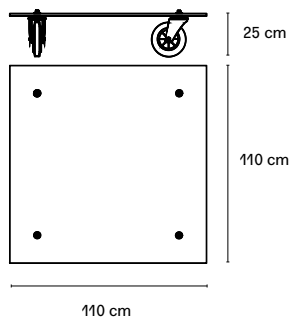

Codice Code	Materiale Material	Colore Colour	Prezzo no IVA Price VAT excluded
F1120TB150TR20	Vetro, Metallo Glass, Metal	 Trasparente, Nero Transparent, Black	1.279,00 €

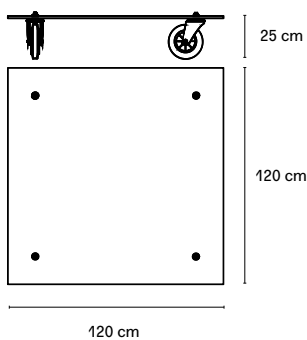

Codice Code	Materiale Material	Colore Colour	Prezzo no IVA Price VAT excluded
F1130TB150TR30	Vetro, Metallo Glass, Metal	 Trasparente, Nero Transparent, Black	1.303,00 €

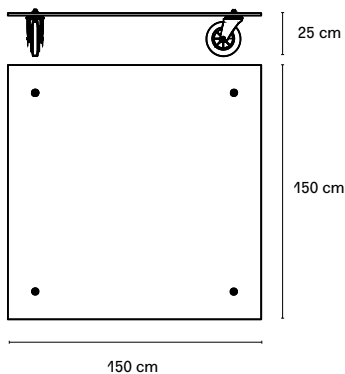

Codice Code	Materiale Material	Colore Colour	Prezzo no IVA Price VAT excluded
F1140TB150TR40	Vetro, Metallo Glass, Metal	 Trasparente, Nero Transparent, Black	1.680,00 €



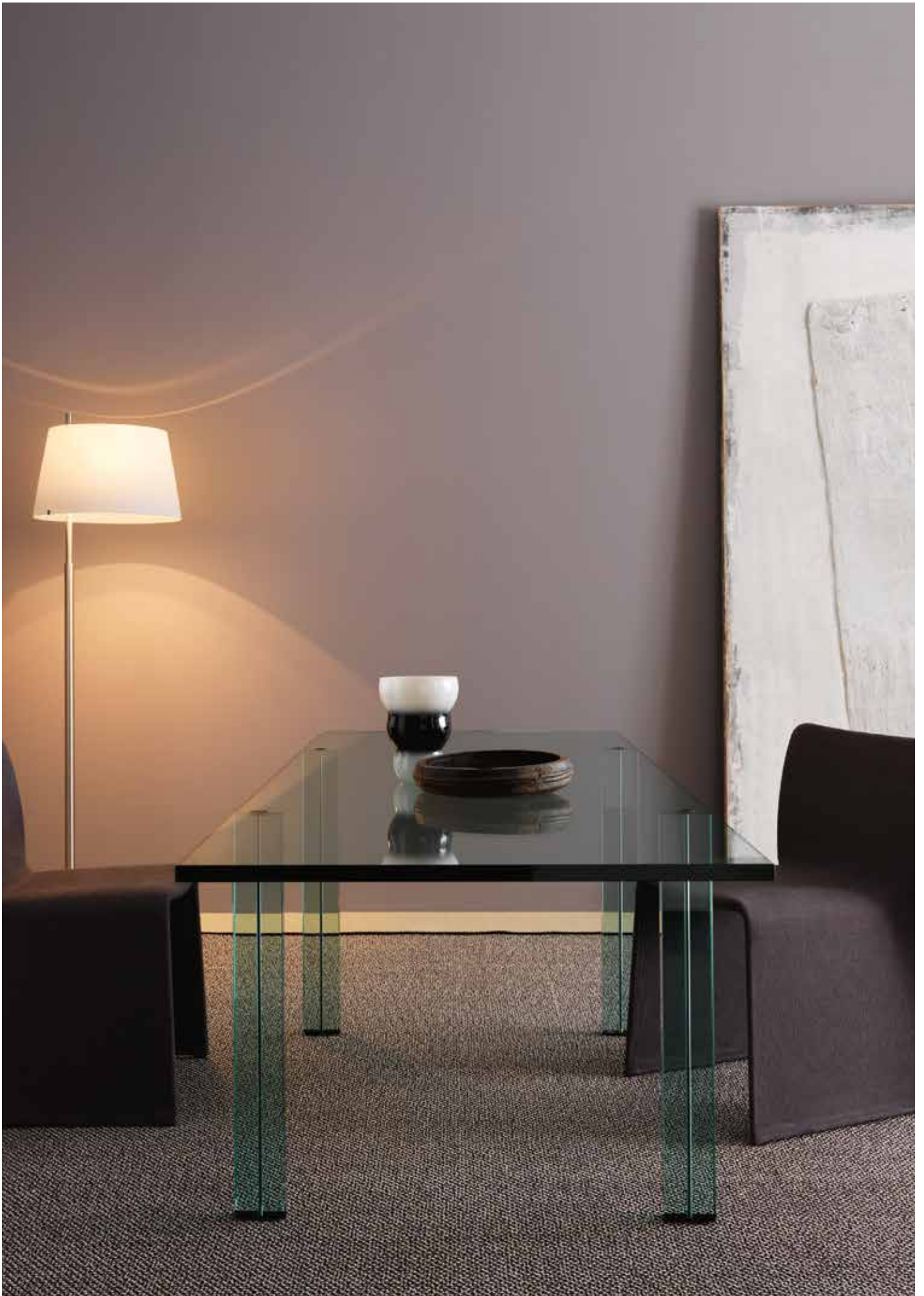

# TESO

Renzo Piano, 1985

Renzo Piano si misura per la prima volta con il campo del design progettando per FontanaArte una produzione coordinata di sistemi d'arredo in un unico materiale: il vetro, simbolo della storia produttiva dell'azienda. Una collezione di grandissimo pregio, composta da tavolo, libreria e consolle.

Tavolo con piano e gambe in vetro float stratificato. Nelle gambe è presente una scanalatura per l'inserimento di tiranti in metallo verniciato.

Renzo Piano made his design debut with a coordinated line of furnishing systems for FontanaArte, using only one material: glass, symbol of the company's production history. A very fine collection that comprises table, bookcase and console.

Table with top and legs made of laminated float-glass. In the legs there is a groove to contain painted metal ties.

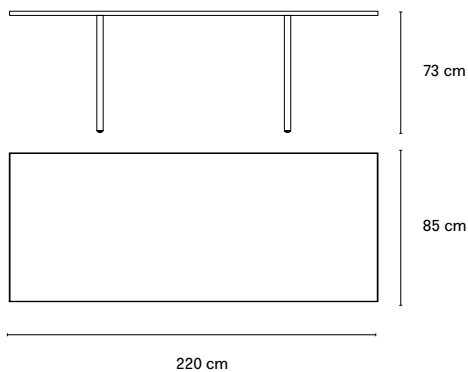

Codice Code	Materiale Material	Colore Colour	Prezzo no IVA Price VAT excluded
F2720TA150TR20	Vetro, Metallo Glass, Metal	 Trasparente Transparent	4.549,00 €









# TESO

Renzo Piano, 1991

Renzo Piano si misura per la prima volta con il campo del design progettando per FontanaArte una produzione coordinata di sistemi d'arredo in un unico materiale: il vetro, simbolo della storia produttiva dell'azienda. Una collezione di grandissimo pregio, composta da tavolo, libreria e consolle.

Consolle aperta sui due lati. Ripiani e montanti in vetro float. Tiranti in metallo cromato.

Renzo Piano made his design debut with a coordinated line of furnishing systems for FontanaArte, using only one material: glass, symbol of the company's production history. A very fine collection that comprises table, bookcase and console.

Console open on two fronts. Shelves and uprights made of float-glass. Chromed metal ties.

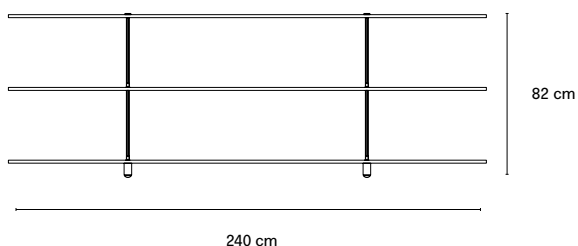

Codice Code	Materiale Material	Colore Colour	Prezzo no IVA Price VAT excluded
F2720CO150TR20	Vetro, Metallo Glass, Metal	Trasparente Transparent	4.057,00 €





# TESO

Renzo Piano, 1989

Renzo Piano si misura per la prima volta con il campo del design progettando per FontanaArte una produzione coordinata di sistemi d'arredo in un unico materiale: il vetro, simbolo della storia produttiva dell'azienda. Una collezione di grandissimo pregio, composta da tavolo, libreria e consolle.

Libreria aperta sui due lati. Ripiani e montanti in vetro float. Tiranti in metallo cromato.

Renzo Piano made his design debut with a coordinated line of furnishing systems for FontanaArte, using only one material: glass, symbol of the company's production history. A very fine collection that comprises table, bookcase and console.

Bookcase open on two fronts. Shelves and uprights made of float-glass. Chromed metal ties.

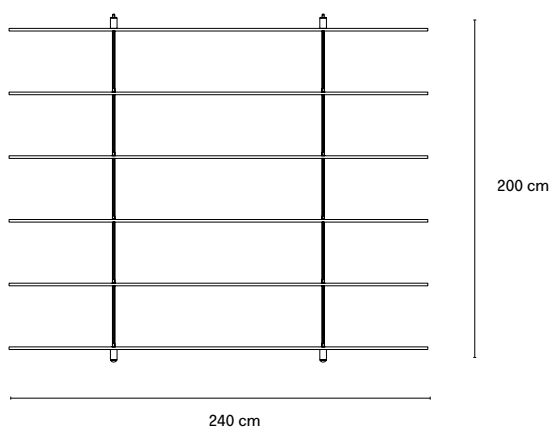

Codice Code	Materiale Material	Colore Colour	Prezzo no IVA Price VAT excluded
F2720LM150TR20	Vetro, Metallo Glass, Metal	Trasparente Transparent	7.828,00 €



# TOUR

*Gae Aulenti, 1993*

Tour rappresenta la declinazione successiva del Tavolo con Ruote. Dotato anch'esso di ruote, in questo caso di bicicletta, è un pezzo sorprendente.

Tavolo con piano in vero float molato. Ruote pivotanti fissate al piano mediante 4 piattelli in acciaio inox. Forcelle cromate. Copertoni in gomma piena.

Tour is the evolution of the Table with Wheels. Again with wheels, but in this case taken from bicycles, it was a surprising piece.

Table with ground float-glass top. Rotating wheels fixed to the top by four stainless steel plates. Chromium-plated brackets. All-rubber wheels.

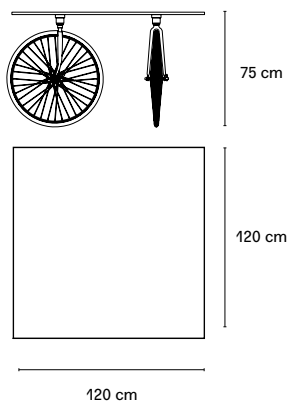

Codice Code	Materiale Material	Colore Colour	Prezzo no IVA Price VAT excluded
F3010TA150TR10	Vetro, Metallo Glass, Metal	 Trasparente, Cromo Transparent, Chrome	4.877,00 €

## LEGENDA / LEGEND





Marchatura obbligatoria che attesta la conformità del prodotto alle disposizioni delle direttive e regolamenti comunitari.  
Mandatory marking certifying the conformity of the product to the community directives and rules.



Il Certificato di conformità EAC (EurAsian Conformity) indica che i prodotti si adeguano a tutte le normative tecniche delle procedure di valutazione dell'Unione doganale eurasiatica.  
The EurAsian Conformity mark (EAC) is a certification mark to indicate that the products conform to all technical regulations of the Eurasian Customs Union.



Marchio di certificazione per il mercato nord americano che certifica che il prodotto è conforme e rispetta i requisiti delle normative nordamericane.  
Mark of certification for the american market that certifies that the product is conform to the North American standards.



Marchio di Certificazione Cinese.  
China Compulsory Certification.



Indice di protezione contro la penetrazione di corpi solidi e di liquidi.  
Protection degree offered by the fixture to the ingress of solids and liquids.



La prima cifra indica, protezione contro la penetrazione di corpi solidi:

- (0) Nessuna protezione  
(1) Protezione contro i corpi solidi di dimensioni superiori a 50mm  
(2) Protezione contro i corpi solidi di dimensioni superiori a 12mm  
(3) Protezione contro i corpi solidi di dimensioni superiori a 2,5mm  
(4) Protezione contro i corpi solidi di dimensioni superiori a 1mm  
(5) Protezione contro la polvere  
(6) Totalmente protetto contro la polvere.

The first number is the protection rating against solid objects:

- (0) No protection  
(1) Protected against solid bodies over 50 mm in diameter  
(2) Protected against solid bodies over 12 mm in diameter  
(3) Protected against solid bodies over 2,5 mm in diameter  
(4) Protected against solid bodies over 1 mm in diameter  
(5) Protected against dust  
(6) Fully protected against dust.



La seconda cifra indica, protezione contro l'infiltrazione di acqua:

- (0) Nessuna protezione  
(1) Protezione contro la caduta in verticale di gocce d'acqua  
(2) Protezione contro la caduta in verticale di gocce d'acqua con angolo di inclinazione massimo di 15°  
(3) Protezione contro la caduta in verticale di gocce d'acqua con angolo di inclinazione massimo di 60°  
(4) Protezione contro gli spruzzi d'acqua  
(5) Protezione contro i getti d'acqua  
(6) Protezione contro le ondate d'acqua  
(7) Protezione contro l'immersione  
(8) Protezione contro l'immersione prolungata.

The second number is the protection against liquids:

- (0) No protection  
(1) Protected against drops of water falling vertically  
(2) Protected against drops of water at a max. inclination of 15 degrees  
(3) Protected against drops of water at a max. inclination of 60 degrees  
(4) Protected against splashed of water  
(5) Protected against jets of water  
(6) Protected against waves  
(7) Protected against immersion  
(8) Protected against long term immersion.



Apparecchio in cui la protezione contro la scossa elettrica non si basa unicamente sull'isolamento principale, ma anche su misure supplementari di sicurezza quali il doppio isolamento o l'isolamento rinforzato. Questi apparecchi non prevedono la messa a terra.

Light fittings whose safety is guaranteed only by the double and / or reinforced insulation of all parts, with no earth.



Apparecchio in cui la protezione contro la folgorazione elettrica si basa sull'alimentazione a bassissima tensione e in cui non si producono tensioni superiori alla stessa (SELV).

Light fitting fitted with a protection device against electric shock that features a very low voltage power supplied and prevents it from generating higher voltages (SELV).



Indice di resa cromatica.  
Colour rendering index.



Il procedimento per dare una forma al vetro è la soffiatura: libera o a stampo. La tecnica di soffiatura può essere variata utilizzando stampi di ferro, bronzo o legno bagnato. In queste forme viene soffiata la massa vitrea, ripetutamente scaldata, che si modella dilatandosi e sagomandosi. La soffiatura del vetro è un'arte che non ha età.

The procedure for shaping glass is blowing: free or moulded. The blowing technique can be varied by using moulds made of iron, bronze or wet wood. Into these forms the heated glass mass is blown and shaped by expanding. Glassblowing is an ageless art.



Lampadina NON inclusa  
Bulb NOT included



Etichetta Energetica  
Energy Label



Prodotto disponibile anche in versione da tavolo  
Product also available in table version



Prodotto disponibile anche in versione da terra  
Product also available in floor version



Prodotto disponibile anche in versione a plafone  
Product also available in ceiling version



Prodotto disponibile anche in versione a parete  
Product also available in wall version



Prodotto disponibile anche in versione a sospensione  
Product also available in suspension version

#### NOTE TECNICHE DIMMER

**Dimmer:** apparecchio dimmerabile tramite pulsante presente sulla lampada o sul cavo (infrarad, microswitch, push button, slider control, touch).

**Dimmerabile (si):** apparecchio dimmerabile tramite pulsante remoto adatto a gestire sorgenti dimmerabili (alogeni, fluorescenti, LED retrofit).

**Dimmerabile (Push):** apparecchio dimmerabile tramite pulsante remoto adatto a gestire driver di tipo Push.

**Dimmerabile (1-10V):** apparecchio dimmerabile tramite pulsante remoto adatto a gestire driver di tipo 1-10V.

**Dimmerabile a taglio di fase:** apparecchio dimmerabile solo con dimmer per moduli LED a tensione di rete.

**Dimmerabile TRIAC:** I dimmer TRIAC più recenti possono dimmerare lampade a LED

#### DIMMER TECHNICAL NOTES

**Dimmer:** dimmable fixture by means of a switch situated on the lamp structure or on cable (infrared, microswitch, push button, slider control, touch).

**Dimmable (yes):** dimmable fixture by means of a remote switch able to manage dimmable sources (halogens, fluorescents, LED Retrofit).

**Dimmable (Push):** dimmable fixture by means of a remote switch able to manage Push Drivers.









**Dimmable (1-10V):** dimmable fixture by means of a remote switch able to manage 1.10V Drivers.







**Dimmable with phase cut dimmer:** dimmable fixture only with dimmer for LED modules for mains voltage.



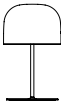

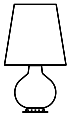
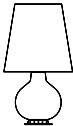

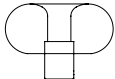
**Dimmerabile TRIAC:** The latest TRIAC dimmers can dim LED lamps



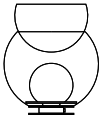



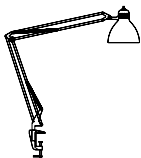

RICAMBI / SPARE PARTS

**LAMPADE DA TAVOLO /**  
**TABLE LAMPS**

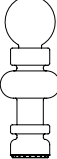

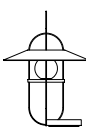

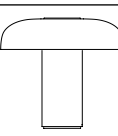

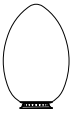

Famiglia Family		Codice prodotto finito Product code	Codice ricambio Spare part code	Descrizione Description	Prezzo no IVA Price VAT excluded
3247TA		F324700150KBNE	R185300V01BI00	Diffusore Superiore Top Diffuser	189,00 €
			R324703M00NS00	Montatura Mounting	344,00 €
		F324710150KBNE	R185301V01BI00	Diffusore Superiore Top Diffuser	430,00 €
			R324702M00NS00	Montatura Mounting	475,00 €
BILIA MINI		F247400150BINE	R440400V00BI00	Diffusore in vetro con ghiera Diffuser with metal ring	107,00 €
		F247400150BLNE	R440400V00BI00	Diffusore in vetro con ghiera Diffuser with metal ring	107,00 €
		F247400150GINE	R440400V00BI00	Diffusore in vetro con ghiera Diffuser with metal ring	107,00 €
		F247400150KBNE	R440400V00BI00	Diffusore in vetro con ghiera Diffuser with metal ring	107,00 €
		F247400150NENE	R440400V00BI00	Diffusore in vetro con ghiera Diffuser with metal ring	107,00 €
		F247400150RONE	R440400V00BI00	Diffusore in vetro con ghiera Diffuser with metal ring	107,00 €
		F247400150TBNE	R440400V00BI00	Diffusore in vetro con ghiera Diffuser with metal ring	107,00 €
		F247400150VENE	R440400V00BI00	Diffusore in vetro con ghiera Diffuser with metal ring	107,00 €
		F247400550NENE	R440400V00BI00	Diffusore in vetro con ghiera Diffuser with metal ring	107,00 €
		F247400550RSNE	R440400V00BI00	Diffusore in vetro con ghiera Diffuser with metal ring	107,00 €
		BILIA MEDIA		F247405150KBNE	R247400V00BI00
F247405150TBNE	R247400V00BI00			Diffusore bianco White diffuser	139,00 €
F247405550NENE	R247400V00BI00			Diffusore bianco White diffuser	139,00 €
F247405550RSNE	R247400V00BI00			Diffusore bianco White diffuser	139,00 €
BIS - TRIS		F228005150TNNE	R228000V01NE00	Diffusore superiore Top diffuser	545,00 €
			R228000V02OP00	Diffusore inferiore Bottom diffuser	131,00 €
		F228005150CBNE	R228000V01BI00	Diffusore superiore Top diffuser	467,00 €
			R228000V02OP00	Diffusore inferiore Bottom diffuser	131,00 €
DARUMA		F502800100BINE	R502800V01BI00	Diffusore superiore Top diffuser	143,00 €
			R502800V02BI00	Diffusore inferiore Bottom diffuser	160,00 €
		F502805100BINE	R502801V01BI00	Diffusore superiore Top diffuser	160,00 €
			R502801V02BI00	Diffusore superiore Top diffuser	283,00 €
		F502810100BINE	R502802V01BI00	Diffusore superiore Top diffuser	270,00 €
			R502802V02BI00	Diffusore inferiore Bottom diffuser	578,00 €
EQUATORE		F438900150OOWL	R438900V00BR00	Diffusore Diffuser	377,00 €
		F438900550NEWL	R438900V00NE00	Diffusore Diffuser	377,00 €
		F438900550RSWL	R438900V00RS00	Diffusore Diffuser	377,00 €
		F438900550CRWL	R438900V00TR00	Diffusore Diffuser	377,00 €

Famiglia Family		Codice prodotto finito Product code	Codice ricambio Spare part code	Descrizione Description	Prezzo no IVA Price VAT excluded	
		F438905150OOWL	R438901V00BR00	Diffusore Diffuser	467,00 €	
		F438905550NEWL	R438901V00NE00	Diffusore Diffuser	467,00 €	
		F438905550RSWL	R438901V00RS00	Diffusore Diffuser	467,00 €	
		F438905550CRWL	R438901V00TR00	Diffusore Diffuser	467,00 €	
<b>FALENA</b>		F301705150CRNE	R301600M08CR00	Corpo Body	320,00 €	
			R301700B00TR00	Base Base	287,00 €	
<b>FONTANA</b>		F185300100BINE	R185300V01BI00	Diffusore superiore Top diffuser	189,00 €	
			R185301V02BI00	Globo Globe	131,00 €	
			R185301M00BI00	Montatura completa Complete mounting	455,00 €	
			R185301M01BI00	Crociera reggivetrol Glassholder cross	70,00 €	
			R185300T00NE00	Tastiera Switch	25,00 €	
			F185305100BINE	R185301V01BI00	Diffusore superiore Top diffuser	430,00 €
			R185300V02BI00	Globo Globe	234,00 €	
			R185300M00BI00	Montatura completa Complete mounting	590,00 €	
			R185300M01BI00	Crociera reggivetrol Glassholder cross	94,00 €	
			R185300T00NE00	Tastiera Switch	25,00 €	
		F185310100BINE	R185302V01BI00	Diffusore superiore Top diffuser	881,00 €	
		R185302V02BI00	Globo Globe	410,00 €		
		R185302M00BI00	Montatura completa Complete mounting	971,00 €		
		R248202M01BI00	Crociera reggivetrol Glassholder cross	98,00 €		
		R185301T00NE00	Tastiera Switch	37,00 €		
		R185300M02BI00	Riflettore Top reflector	53,00 €		
<b>FONTANELLA</b>		F442305550NENE	R442300V00TR00	Diffusore Diffuser	348,00 €	
		F442305550OTNE	R442300V00TR00	Diffusore Diffuser	348,00 €	
		F442310550NENE	R442301V00TR00	Diffusore Diffuser	529,00 €	
		F442310550OTNE	R442301V00TR00	Diffusore Diffuser	529,00 €	
<b>GIOVA</b>		F268405150CRNE	R264800V02TR00	Diffusore trasparente Transparent diffuser	320,00 €	
			R264800V03BI00	Diffusore bianco White diffuser	127,00 €	
			R264800V01RS00	Diffusore rosa Pink diffuser	230,00 €	
		F268405575OONE	R264800V02TR00	Diffusore trasparente Transparent diffuser	320,00 €	
			R264801V03BI00	Diffusore bianco White diffuser	127,00 €	
			R264800V01GC00	Diffusore grigio chiaro Light grey diffuser	361,00 €	





Famiglia Family		Codice prodotto finito Product code	Codice ricambio Spare part code	Descrizione Description	Prezzo no IVA Price VAT excluded
		F268410150CRNE	R264801V02TR00	Diffusore trasparente Transparent diffuser	721,00 €
			R264801V03BI00	Diffusore bianco White diffuser	152,00 €
			R264801V01RS00	Diffusore rosa Pink diffuser	373,00 €
		F268410575OONE	R264801V02TR00	Diffusore trasparente Transparent diffuser	721,00 €
			R264801V03BI00	Diffusore bianco White diffuser	152,00 €
			R264801V01GC00	Diffusore grigio chiaro Light grey diffuser	410,00 €
MANO		F420805400NENE	R420800M00NE00	Montatura Mounting	434,00 €
			R420800V00NE00	Diffusore Diffuser	172,00 €
MERIDIANO		F441705550NFWL	R441700V00NE00	Diffusore Diffuser	602,00 €
METAFORA		F265405150BTNE	R265400V00OP00	Diffusore Diffuser	426,00 €
NASKA		F810700200BINE	R800400M08BI00	Corpo Body	230,00 €
			R810700B00BI00	Base Base	78,00 €
		F810700200NENE	R800400M08NE00	Corpo Body	303,00 €
			R810700B00NE00	Base Base	78,00 €
		F810700240CRNE	R800400M08CR00	Corpo Body	340,00 €
			R810700B00CR00	Base Base	119,00 €
		F810100200BINE	R800400M08BI00	Corpo Body	230,00 €
			R810100B01BI00	Morsetto Clamp	33,00 €
		F810100200NENE	R800400M08NE00	Corpo Body	303,00 €
			R810100B01NE00	Morsetto Clamp	33,00 €
		F810100240CRNE	R800400M08CR00	Corpo Body	340,00 €
			R810100B01CR00	Morsetto Clamp	33,00 €
		F810010200BINE	R800000M08BI00	Corpo Body	250,00 €
			R810000B00BI00	Base Base	143,00 €
		F810010200NENE	R800000M08BI00	Corpo Body	250,00 €
			R810000B00NE00	Base Base	143,00 €
		F810010240CRNE	R800000M08BI00	Corpo Body	250,00 €
			R810000B00CR00	Base Base	160,00 €
	F810110200BINE	R800000M08BI00	Corpo Body	250,00 €	
		R810100B01BI00	Morsetto Clamp	33,00 €	
	F810110200NENE	R800000M08NE00	Corpo Body	336,00 €	
		R810100B01NE00	Morsetto Clamp	33,00 €	
	F810110240CRNE	R800000M08CR00	Corpo Body	361,00 €	
		R810100B01CR00	Morsetto Clamp	33,00 €	

Famiglia Family		Codice prodotto finito Product code	Codice ricambio Spare part code	Descrizione Description	Prezzo no IVA Price VAT excluded
<b>PALLINA</b>		F443000150NENE	R440400V00BI00	Diffusore Diffuser	107,00 €
		F443000150NSNE	R440400V00BI00	Diffusore Diffuser	107,00 €
		F443000150OTNE	R440400V00BI00	Diffusore Diffuser	107,00 €
		F443000150ORNE	R440400V00BI00	Diffusore Diffuser	107,00 €
<b>PAROLA</b>		F265805100AMNE	R265800B00TR00	Montatura Mounting	291,00 €
			R265800V00AM00	Diffusore Diffuser	279,00 €
		F265805100BINE	R265800B00TR00	Montatura Mounting	291,00 €
			R265800V00BI00	Diffusore Diffuser	279,00 €
<b>PIRELLINA</b>		F278205150KBNE	R278200V00BI00	Diffusori Diffusers	234,00 €
<b>RE</b>		F443810100BIWL	R443800V00BI00	Diffusore superiore Top diffuser	381,00 €
			R443800V02BI00	Diffusore inferiore Bottom diffuser	367,00 €
			R443800V03BI00	Diffusore centrale Central diffuser	697,00 €
<b>REGINA</b>		F443710100BIWL	R443700V00BI01	Diffusore superiore Top diffuser	373,00 €
			R443700V00BI00	Diffusore centrale Central diffuser	758,00 €
<b>SETAREH</b>		F438405500NBWL	R438G00V00BI00	Diffusore Diffuser	131,00 €
			R440400V00BI00	Diffusore in vetro con ghiera / Diffuser with metal ring	107,00 €
		F438405500OBWL	R438G00V00BI00	Diffusore Diffuser	131,00 €
			R440400V00BI00	Diffusore in vetro con ghiera / Diffuser with metal ring	107,00 €
<b>THOR</b>		F329500100BINE	R329501V00BI00	Diffusore Diffuser	262,00 €
			R329500V00BI00	Diffusore bianco White diffuser	332,00 €
<b>TROPICO</b>		F442105585BIWL	R443101V00BI00	Diffusore Diffuser	291,00 €
		F442105585GCWL	R443101V00BI00	Diffusore Diffuser	291,00 €
		F442105585NEWL	R443101V00BI00	Diffusore Diffuser	291,00 €
		F442110585BIWL	R443102V00BI00	Diffusore Diffuser	389,00 €
		F442110585GCWL	R443102V00BI00	Diffusore Diffuser	389,00 €
		F442110585NEWL	R443102V00BI00	Diffusore Diffuser	389,00 €
<b>UOVO</b>		F264600100BINE	R264601V00BI00	Diffusore Diffuser	180,00 €
			R264601M00BI00	Montatura Mounting	168,00 €
		F264605100BINE	R264602V00BI00	Diffusore Diffuser	242,00 €
			R264602M00BI00	Montatura Mounting	189,00 €
		F264610100BINE	R264600V00BI00	Diffusore Diffuser	447,00 €
			R264600M00BI00	Montatura Mounting	234,00 €









## LAMPADE DA TERRA / FLOOR LAMPS

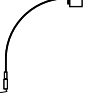







Famiglia Family		Codice prodotto finito Product code	Codice ricambio Spare part code	Descrizione Description	Prezzo no IVA Price VAT excluded	
3247		F324725150KBNE	R185301V01BI00	Diffusore Diffuser	430,00 €	
			R324701M00NS00	Montatura Mounting	697,00 €	
		F324730150KBNE	R185302V01BI00	Diffusore Diffuser	881,00 €	
			R324700M00NS00	Montatura Mounting	1.107,00 €	
EQUATORE		F439220150OOWL	R438900V00BR00	Diffusore Diffuser	377,00 €	
		F439220550NEWL	R438900V00NE00	Diffusore Diffuser	377,00 €	
		F439220550RSWL	R438900V00RS00	Diffusore Diffuser	377,00 €	
		F439220550CRWL	R438900V00TR00	Diffusore Diffuser	377,00 €	
		F439225550NEWL	R438901V00NE00	Diffusore Diffuser	467,00 €	
		F439225150OOWL	R438901V00BR00	Diffusore Diffuser	467,00 €	
		F439225550RSWL	R438901V00RS00	Diffusore Diffuser	467,00 €	
		439225550CRWL	R438901V00TR00	Diffusore Diffuser	467,00 €	
FLÛTE		F330025150TCNE	R330000V04TC00	Diffusore per attacco E27 Diffuser for E27 socket	635,00 €	
			F330030150TCNE	R330000M00TC00	Montatura Mounting	1.721,00 €
				R330000B00CR00	Base Base	365,00 €
	R330001V04TC00		Stelo in vetro Glass stem	1.000,00 €		
LUMEN		F248225150BINE	R185302V01BI00	Diffusore Diffuser	881,00 €	
			R248200M00BI00	Montatura Mounting	1.000,00 €	
MERIDIANO		F441725550NFWL	R441700V00NE00	Diffusore Diffuser	602,00 €	



Famiglia Family		Codice prodotto finito Product code	Codice ricambio Spare part code	Descrizione Description	Prezzo no IVA Price VAT excluded
PAROLA		F268945150AMNE	R265800V00AM00	Diffusore Diffuser	279,00 €
		F268945150BINE	R265800V00BI00	Diffusore Diffuser	279,00 €
PAROLONA		F275130150BINE	R275100V00BI00	Diffusore Diffuser	340,00 €
PIRELLONE		F275930150KBNE	R275900V00BI00	Diffusore Singolo Single Diffuser	750,00 €
			R275901V00BI00	Diffusore Doppio Double Diffuser	1.246,00 €
			R275800M00NS00	Montatura Mounting	1.480,00 €
PRIMA SIGNORA		F289130150CBNE	R289100V00BI00	Diffusore Diffuser	467,00 €







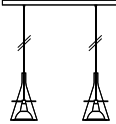
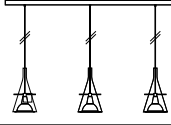

**LAMPADE A PARETE E A PLAFONE /**  
**WALL AND CEILING LAMPS**

Famiglia Family		Codice prodotto finito Product code	Codice ricambio Spare part code	Descrizione Description	Prezzo no IVA Price VAT excluded
BRUCO		F353845100BINE	R353800V01BI00	Diffusore superiore Top diffuser	74,00 €
		F353845100BINE	R353800V02BI00	Diffusore inferiore Bottom diffuser	119,00 €
FALENA		F301945150CRNE	R301600M08CR00	Corpo Body	320,00 €
			R301900B02CR00	Montatura Mounting	156,00 €
FRENESE		F446745550TCLE	R446745V00TR00	Diffusore Diffuser	1.189,00 €
NASKA		F810340200BINE	R800400M08BI00	Corpo Body	230,00 €
			R810300B02BI00	Attacco a parete Wall support	33,00 €
		F810340200NENE	R800400M08NE00	Corpo Body	303,00 €
			R810300B02NE00	Attacco a parete Wall support	33,00 €
		F810340240CRNE	R800400M08CR00	Corpo Body	340,00 €
			R810300B02CR00	Attacco a parete Wall support	33,00 €
		F810350200BINE	R800000M08BI00	Corpo Body	250,00 €
			R810300B02BI00	Attacco a parete Wall support	33,00 €
		F810350200NENE	R800000M08NE00	Corpo Body	336,00 €
			R810300B02NE00	Attacco a parete Wall support	33,00 €
		F810350240CRNE	R800000M08CR00	Corpo Body	361,00 €
			R810300B02CR00	Attacco a parete Wall support	33,00 €
NOBI		F302345150BINE	R308600V00OP00	Diffusore Diffuser	57,00 €
			R308600M02AL00	Riflettore Reflector	70,00 €
		F302345150CRLE	R308600V00OP00	Diffusore Diffuser	57,00 €
			R308600M02AL00	Riflettore Reflector	70,00 €
		F302345150NSLE	R308600V00OP00	Diffusore Diffuser	57,00 €
			R308600M02AL00	Riflettore Reflector	70,00 €
PALLINA		F443060150NENE	R440400V00BI00	Diffusore Diffuser	107,00 €
		F443060150NSNE	R440400V00BI00	Diffusore Diffuser	107,00 €
		F443060150OTNE	R440400V00BI00	Diffusore Diffuser	107,00 €
		F443060150NSNE	R440400V00BI00	Diffusore Diffuser	107,00 €
PAROLA		F268945150AMNE	R265800V00AM00	Diffusore Diffuser	279,00 €
		F268945150BINE	R265800V00BI00	Diffusore Diffuser	279,00 €
RIGA		F521440260BILE	R521401V00OP00	Diffusore Diffuser	25,00 €
		F521440260NSLE	R521401V00OP00	Diffusore Diffuser	25,00 €

Famiglia Family		Codice prodotto finito Product code	Codice ricambio Spare part code	Descrizione Description	Prezzo no IVA Price VAT excluded
		F539845260NSLE	R539800V00OP00	Diffusore Diffuser	25,00 €
		F539845250BILE	R539800V00OP00	Diffusore Diffuser	25,00 €
		F521450260NSLE	R521400V00OP00	Diffusore Diffuser	37,00 €
		F521450250BILE	R521400V00OP00	Diffusore Diffuser	37,00 €
<b>SCINTILLA</b>		FP15045250CRNE	RP15000V05TR00	Schermo superiore Upper protection	19,00 €
			RP15000V06TR00	Schermo inferiore Lower protection	19,00 €
			RS15000M02AL00	Riflettore Reflector	61,00 €
		FP15045250NSNE	RP15000V05TR00	Schermo superiore Upper protection	19,00 €
			RP15000V06TR00	Schermo inferiore Lower protection	19,00 €
			RP15000M02AL00	Riflettore Reflector	61,00 €
		FP30050250CRNE	RP30000V05TR00	Schermo Superiore Upper Protection	25,00 €
			RP30000V06TR00	Schermo inferiore Lower protection	25,00 €
			RS30000M02AL00	Riflettore Reflector	41,00 €
		FP30050250NSNE	RP30000V05TR00	Schermo superiore Upper protection	25,00 €
			RP30000V06TR00	Schermo inferiore Lower protection	25,00 €
			RP15000M02AL00	Riflettore Reflector	41,00 €
<b>SILLABA</b>		F277560150BINE	R277500V00OP00	Diffusore Diffuser	74,00 €
		F277570150BINE	R277502V00OP00	Diffusore Diffuser	135,00 €
		F277570150BILE	R277502V00OP00	Diffusore Diffuser	135,00 €
<b>TROPICO</b>		F442160550NELE	R443100V00BI00	Diffusore Diffuser	217,00 €
		F442160550OOLE	R443100V00BI00	Diffusore Diffuser	217,00 €
		F442165550NELE	R443101V00BI00	Diffusore Diffuser	291,00 €
		F442165550OOLE	R443101V00BI00	Diffusore Diffuser	291,00 €
		F442170550NELE	R443102V00BI00	Diffusore Diffuser	389,00 €
		F442170550OOLE	R443102V00BI00	Diffusore Diffuser	389,00 €

## LAMPADE A SOSPENSIONE / SUSPENSION LAMPS

Famiglia Family	Codice prodotto finito Product code	Codice ricambio Spare part code	Descrizione Description	Prezzo no IVA Price VAT excluded	
0024	F002485150TRNE	R002400V00TR00	Set dischi diffusori Set glass disks	1.086,00 €	
AMAX	F544480350BINE	R544400V00BI00	Diffusore Diffuser	209,00 €	
	F544485350BINE	R544401V00BI00	Diffusore Diffuser	262,00 €	
	F544490350BINE	R544402V00BI00	Diffusore Diffuser	537,00 €	
		R556201K00CB00	Kit disco chiusura Closing disk kit	365,00 €	
	F544495350BINE	R544403V00BI00	Diffusore Diffuser	791,00 €	
		R556200K00CB00	Kit disco chiusura Closing disk kit	447,00 €	
	AVICO	F556180350BINE	R556100V00BI00	Diffusore bianco White diffuser	738,00 €
		R556203K00CB00	Kit disco chiusura Closing disk kit	447,00 €	
	F556185350BINE	R556101V00BI00	Diffusore bianco White diffuser	906,00 €	
	R556200K00CB00	Kit disco chiusura Closing disk kit	447,00 €		
BOLLA		R356700V00TR00	Diffusore Diffuser	381,00 €	
		R356701V00TR00	Diffusore Diffuser	508,00 €	
EQUATORE	F439085150OOLE	R439001V00BR00	Diffusore Diffuser	475,00 €	
	F439085550NELE	R439001V00NE00	Diffusore Diffuser	475,00 €	
	F439085550RSLE	R439001V00RS00	Diffusore Diffuser	475,00 €	
	F439085550CRLE	R439001V00TR00	Diffusore Diffuser	475,00 €	
	F439090150OOLE	R439002V00BR00	Diffusore Diffuser	779,00 €	
	F439090550NELE	R439002V00NE00	Diffusore Diffuser	779,00 €	
	F439090550RSLE	R439002V00RS00	Diffusore Diffuser	779,00 €	
	F439090550CRLE	R439002V00TR00	Diffusore Diffuser	779,00 €	
FLÔTE	F333780150TCNE	R333700V00TR00	Diffusore Diffuser	287,00 €	
	F333780550NENE	R333700V00TR00	Diffusore Diffuser	287,00 €	
	F333780550OTNE	R333700V00TR00	Diffusore Diffuser	287,00 €	

Famiglia Family	Codice prodotto finito Product code	Codice ricambio Spare part code	Descrizione Description	Prezzo no IVA Price VAT excluded
	F333785150TCNE	R333700V00TR00	Diffusore Diffuser	287,00 €
	F333790150TCNE	R333700V00TR00	Diffusore Diffuser	287,00 €
	F333790150TCNE	R333700V00TR00	Diffusore Diffuser	287,00 €
	F364480150CRNE	R364400V00CR00	Diffusore Diffuser	270,00 €
	F364480150RMNE	R364400V00RM00	Diffusore Diffuser	283,00 €
	F364485150CRNEW	R364402V00CR00	Diffusore Diffuser	389,00 €
	F364485150RMNE	R364402V00RM00	Diffusore Diffuser	414,00 €
	F364490150CRNE	R364401V00CR00	Diffusore Diffuser	619,00 €
	F364490150RMNE	R364401V00RM00	Diffusore Diffuser	639,00 €
	F441785550NFLE	R441700V00NE00	Diffusore Diffuser	602,00 €
	F441785550NFLE	R441700V00NE00	Diffusore Diffuser	602,00 €
	F441790550NFLE	R441701V00NE00	Diffusore Diffuser	936,00 €
	F443080150NENE	R440400V00BI00	Diffusore in vetro con ghiera Diffuser with metal ring	107,00 €
	F443080150NSNE	R440400V00BI00	Diffusore in vetro con ghiera Diffuser with metal ring	107,00 €
	F443080150OTNE	R440400V00BI00	Diffusore in vetro con ghiera Diffuser with metal ring	107,00 €
	F428485100AMNE	R428400V00AM00	Diffusore Diffuser	283,00 €
	F428485100BINE	R428400V00BI00	Diffusore Diffuser	283,00 €
	FS30090250CRNE	RP30000V05TR00	Vetro protezione superiore trasparente Upper transparent protection glass	25,00 €
		RP30000V06TR00	Vetro protezione inferiore trasparente Lower transparent protection glass	25,00 €
		R279100V05OP00	Vetro protezione superiore sabbiato Upper sandblasted protection glass	29,00 €
		RP30000V06OP00	Vetro protezione inferiore sabbiato Lower sandblasted protection glass	29,00 €
		RP30000M03AX00	Molla fissaggio vetro inferiore Lower protection glass spring holder	6,00 €
		RP15000M03AX00	Molla fissaggio vetro superiore Upper protection glass spring holder	6,00 €
		RS30000M02AL00	Riflettore Reflector	41,00 €
	FS30090250NSNE	RP30000V05TR00	Vetro protezione superiore trasparente Upper transparent protection glass	25,00 €
		RP30000V06TR00	Vetro protezione inferiore trasparente Lower transparent protection glass	25,00 €

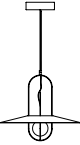
Famiglia Family	Codice prodotto finito Product code	Codice ricambio Spare part code	Descrizione Description	Prezzo no IVA Price VAT excluded	
		R279100V05OP00	Vetro protezione superiore sabbato Upper sandblasted protection glass	29,00 €	
		RP30000V06OP00	Vetro protezione inferiore sabbato Lower sandblasted protection glass	29,00 €	
		RP30000M03AX00	Molla fissaggio vetro inferiore Lower protection glass spring holder	6,00 €	
		RP15000M03AX00	Molla fissaggio vetro superiore Upper protection glass spring holder	6,00 €	
		RS30000M02AL00	Riflettore Reflector	41,00 €	
<b>SETAREH</b>		F438G85550NBLE	R438G01V00BI00	Diffusore Diffuser	197,00 €
			R440400V00BI00	Diffusore in vetro con ghiera Diffuser with metal ring	107,00 €
		F438G85550OBLE	R438G01V00BI00	Diffusore Diffuser	197,00 €
			R440400V00BI00	Diffusore in vetro con ghiera Diffuser with metal ring	107,00 €

**ARREDO /  
FURNITURE**

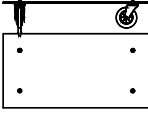
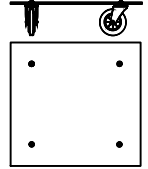
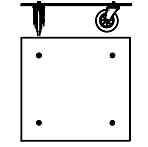
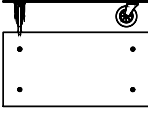
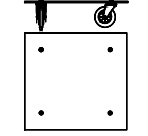
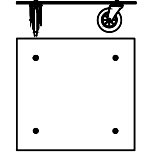
Famiglia Family	Codice prodotto finito Product code	Codice ricambio Spare part code	Descrizione Description	Prezzo no IVA Price VAT excluded
TAVOLO CON RUOTE	 F1000TB150TR00	R265200V07TR00	Piano vetro 140x70 Glass top 140x70	631,00 €
		R265200M10NE00	Set ruote Set of wheels	730,00 €
	 F1140TB150TR40	R265300V07TR00	Piano vetro 150x150 Glass top 150x150	1.209,00 €
		R265200M10NE00	Set ruote Set of wheels	730,00 €
	 F1130TB150TR30	R274400V07TR00	Piano vetro 120x120 Glass top 120x120	881,00 €
		R265200M10NE00	Set ruote Set of wheels	730,00 €
	 F1010TB150TR10	R274600V07TR00	Piano vetro 100x150 Glass top 100x150	889,00 €
		R265200M10NE00	Set ruote Set of wheels	730,00 €
	 F1110TB150TR00	R274401V07TR00	Piano vetro 100x100 Glass top 100x100	631,00 €
		R265200M10NE00	Set ruote Set of wheels	730,00 €
	 F1120TB150TR20	R274402V07TR00	Piano vetro 110x110 Glass top 110x110	873,00 €
		R265200M10NE00	Set ruote Set of wheels	730,00 €



**MISURE E PESI DELL'IMBALLO /  
PACKAGING MEASUREMENTS AND WEIGHT**

**LAMPADE DA TAVOLO /**  
**TABLE LAMPS**



Famiglia Family	Codice Code	Descrizione Description	Dimensione Size cm A x B x H	Kg netto Kg net	Kg lordo Kg gross
<b>3247TA</b>	F324700150KBNE	DIFFUSORE / DIFFUSER MONTATURA / MOUNTING	27x27x27 28x43x28	1 1,4	2 3
	F324710150KBNE	DIFFUSORE / DIFFUSER MONTATURA / MOUNTING	42x37x42 44x54x44	0,7 4	1,2 6
<b>ASHANGAI</b>	F418805150CBNE	LAMPADA COMPLETA / COMPLETE LAMP	60x90x60	6	14
<b>BIANCA</b>	F430800150BINE	LAMPADA COMPLETA / COMPLETE LAMP	21x16x21	1	1,2
	F430805150BINE	LAMPADA COMPLETA / COMPLETE LAMP	40x27,5x40	3	3,3
	F430810150BINE	LAMPADA COMPLETA / COMPLETE LAMP	61x57x61	6	8,5
<b>BILIA MINI</b>	F247400150BINE	LAMPADA COMPLETA / COMPLETE LAMP	19,5x31x19,5	0,6	0,9
	F247400150BLNE	LAMPADA COMPLETA / COMPLETE LAMP	19,5x31x19,5	0,6	0,9
	F247400150GINE	LAMPADA COMPLETA / COMPLETE LAMP	19,5x31x19,5	0,6	0,9
	F247400150KBNE	LAMPADA COMPLETA / COMPLETE LAMP	19,5x31x19,5	0,6	0,9
	F247400150NENE	LAMPADA COMPLETA / COMPLETE LAMP	19,5x31x19,5	0,6	0,9
	F247400150RONE	LAMPADA COMPLETA / COMPLETE LAMP	19,5x31x19,5	0,6	0,9
	F247400150TBNE	LAMPADA COMPLETA / COMPLETE LAMP	19,5x31x19,5	0,6	0,9
	F247400150VENE	LAMPADA COMPLETA / COMPLETE LAMP	19,5x31x19,5	0,6	0,9
	F247400550NENE	LAMPADA COMPLETA / COMPLETE LAMP	19,5x31x19,5	0,6	0,9
	F247400550RSNE	LAMPADA COMPLETA / COMPLETE LAMP	19,5x31x19,5	0,6	0,9
<b>BILIA</b>	F247405150KBNE	DIFFUSORE / DIFFUSER MONTATURA / MOUNTING	28x30x28 18x37x18	1 0,8	1,5 1,6
	F247405150TBNE	DIFFUSORE / DIFFUSER MONTATURA / MOUNTING	28x30x28 18x37x18	1 0,8	1,5 1,6
	F247405550NENE	DIFFUSORE / DIFFUSER MONTATURA / MOUNTING	28x30x28 18x37x18	1 0,8	1,5 1,6
	F247405550RSNE	DIFFUSORE / DIFFUSER MONTATURA / MOUNTING	28x30x28 18x37x18	1 0,8	1,5 1,6
<b>BIS - TRIS</b>	F228005150CBNE	LAMPADA COMPLETA / COMPLETE LAMP	46x54x46	6,6	9,4
	F228005150TNNE	LAMPADA COMPLETA / COMPLETE LAMP	46x54x46	6,6	9,4
<b>BLOM</b>	F425305350BINE	LAMPADA COMPLETA / COMPLETE LAMP	29x37x29	1	2
	F425305350BLNE	LAMPADA COMPLETA / COMPLETE LAMP	29x37x29	1	2
	F425305350GINE	LAMPADA COMPLETA / COMPLETE LAMP	29x37x29	1	2
	F425305350GSNE	LAMPADA COMPLETA / COMPLETE LAMP	29x37x29	1	2
	F425305350RSNE	LAMPADA COMPLETA / COMPLETE LAMP	29x37x29	1	2
	F425305350VENE	LAMPADA COMPLETA / COMPLETE LAMP	29x37x29	1	2
	F425305350VINE	LAMPADA COMPLETA / COMPLETE LAMP	29x37x29	1	2
<b>BLOM X PARLEY</b>	F425305350TPN1	LAMPADA COMPLETA / COMPLETE LAMP	29x37x29	1	2
	F425305350ACN1	LAMPADA COMPLETA / COMPLETE LAMP	29x37x29	1	2
	F425305350RBN1	LAMPADA COMPLETA / COMPLETE LAMP	29x37x29	1	2
<b>CAMEO</b>	F448005550CRBW	LAMPADA COMPLETA / COMPLETE LAMP	21x21,5x33	1,1	1,6
	F448005160OOBW	LAMPADA COMPLETA / COMPLETE LAMP	21x21,5x33	1,1	1,6
<b>CHESHIRE</b>	F425105350BINE	LAMPADA COMPLETA / COMPLETE LAMP	45,5x74x45,5	6,3	9,8
	F425105350NENE	LAMPADA COMPLETA / COMPLETE LAMP	45,5x74x45,5	6,3	9,3
<b>DARUMA</b>	F502800100BINE	LAMPADA COMPLETA / COMPLETE LAMP	19x26x19	1	1,5
	F502805100BINE	LAMPADA COMPLETA / COMPLETE LAMP	31x41x31	2,2	3
	F502810100BINE	LAMPADA COMPLETA / COMPLETE LAMP	44x55x44	5,8	7,8
<b>EQUATORE</b>	F438900150OOWL	DIFFUSORE / DIFFUSER MONTATURA / MOUNTING	32x22,5x32 32x41x32	1,7 5,2	2,5 6,2
	F438900550CRWL	DIFFUSORE / DIFFUSER MONTATURA / MOUNTING	32x22,5x32 32x41x32	1,7 5,2	2,5 6,2
	F438900550NEWL	DIFFUSORE / DIFFUSER MONTATURA / MOUNTING	32x22,5x32 32x41x32	1,7 5,2	2,5 6,2
	F438900550RSWL	DIFFUSORE / DIFFUSER MONTATURA / MOUNTING	32x22,5x32 32x41x32	1,7 5,2	2,5 6,2
	F438905150OOWL	DIFFUSORE / DIFFUSER MONTATURA / MOUNTING	43x33,5x43 43x50x43	3,4 13	5,3 15
	F438905550CRWL	DIFFUSORE / DIFFUSER MONTATURA / MOUNTING	43x33,5x43 43x50x43	3,4 13	5,3 15
	F438905550NEWL	DIFFUSORE / DIFFUSER MONTATURA / MOUNTING	43x33,5x43 43x50x43	3,4 13	5,3 15
	F438905550RSWL	DIFFUSORE / DIFFUSER MONTATURA / MOUNTING	43x33,5x43 43x50x43	3,4 13	5,3 15

Famiglia Family	Codice Code	Descrizione Description	Dimensione Size cm A x B x H	Kg netto Kg net	Kg lordo Kg gross
	F438905550RSWL	DIFFUSORE / DIFFUSER MONTATURA / MOUNTING	43x33,5x43 43x50x43	3,4 13	5,3 15
<b>FALENA</b>	F301705150CRNE	CORPO / BODY BASE / BASE	70x10x30 27x17x27	0,2 1,3	1 1,7
<b>FONTANA</b>	F185300100BINE	DIFFUSORE / DIFFUSER MONTATURA / MOUNTING	27x27x27 25x25x30	0,7 1	1,2 2
	F185305100BINE	DIFFUSORE / DIFFUSER MONTATURA / MOUNTING	42x37x42 35x45x40	1 3	2 4
	F185310100BINE	DIFFUSORE / DIFFUSER MONTATURA / MOUNTING	54x52x54 55x55x85	4,8 7	7 8
<b>FONTANELLA</b>	F442305550NENE	DIFFUSORE / DIFFUSER MONTATURA / MOUNTING	32,5x32,5x37,5 15x15x11	0,5 1,5	1 2
	F442305550OTNE	DIFFUSORE / DIFFUSER MONTATURA / MOUNTING	32,5x32,5x37,5 15x15x11	0,5 1,5	1 2
	F442310550NENE	DIFFUSORE / DIFFUSER MONTATURA / MOUNTING	32,5x32,5x37,5 15x15x11	0,5 1,5	1 2
	F442310550OTNE	DIFFUSORE / DIFFUSER MONTATURA / MOUNTING	32,5x32,5x37,5 15x15x11	0,5 1,5	1 2
<b>GIOVA</b>	F268405150CRNE	LAMPADA COMPLETA / COMPLETE LAMP	41x78x41	5	7
	F268405575OONE	LAMPADA COMPLETA / COMPLETE LAMP	41x78x41	5	7
	F268410150CRNE	LAMPADA COMPLETA / COMPLETE LAMP	56x83x56	14	17,5
	F268410575OONE	LAMPADA COMPLETA / COMPLETE LAMP	56x83x56	14	17,5
<b>LOOP</b>	F542910200AXLE	LAMPADA COMPLETA / COMPLETE LAMP	55x26x55	8,5	10
<b>MANO</b>	F420805400NELE	MONTATURA / MOUNTING DIFFUSORE / DIFFUSER	28x48x26 42x41x42	3 0,3	4 1,5
<b>MERIDIANO</b>	F441705550NFWL	DIFFUSORE / DIFFUSER MONTATURA / MOUNTING	39x39x49 28x29,5x52,5	2,8 2,7	4,8 4,2
<b>METAFORA</b>	F265405150BTNE	MONTATURA / MOUNTING DIFFUSORE / DIFFUSER	52x46x52 52x32x52	5,5 5	6,5 6
<b>NASKA</b>	F810010200BINE	CORPO / BODY BASE / BASE	18x67x28 29x21x29	2,8 6,6	3,5 7,2
	F810010200NENE	CORPO / BODY BASE / BASE	18x67x28 29x21x29	2,8 6,6	3,5 7,2
	F810010240CRNE	CORPO / BODY BASE / BASE	18x67x28 29x21x29	2,8 6,6	3,5 7,2
	F810100200BINE	CORPO / BODY MORSETTO / CLAMP	23x38x20 15x9x13	1,9 0,1	2,5 0,2
	F810100200NENE	CORPO / BODY MORSETTO / CLAMP	23x38x20 15x9x13	1,9 0,1	2,5 0,2
	F810100240CRNE	CORPO / BODY MORSETTO / CLAMP	23x38x20 15x9x13	1,9 0,1	2,5 0,2
	F810110200BINE	CORPO / BODY MORSETTO / CLAMP	18x67x28 15x9x13	2,8 0,1	3,5 0,2
	F810110200NENE	CORPO / BODY MORSETTO / CLAMP	18x67x28 15x9x13	2,8 0,1	3,5 0,2
	F810110240CRNE	CORPO / BODY MORSETTO / CLAMP	18x67x28 15x9x13	2,8 0,1	3,5 0,2
	F810700200BINE	CORPO / BODY BASE / BASE	23x38x20 26x21x26	1,9 3	2,5 3,5
	F810700200NENE	CORPO / BODY BASE / BASE	23x38x20 26x21x26	1,9 3	2,5 3,5
	F810700240CRNE	CORPO / BODY BASE / BASE	23x38x20 26x21x26	1,9 3	2,5 3,5
<b>PALLINA</b>	F443000150NENE	LAMPADA COMPLETA / COMPLETE LAMP	19x19x19	1	1,5
	F443000150NSNE	LAMPADA COMPLETA / COMPLETE LAMP	19x19x19	1	1,5
	F443000150ORNE	LAMPADA COMPLETA / COMPLETE LAMP	19x19x19	1	1,5
<b>PAROLA</b>	F265805100AMNE	MONTATURA / MOUNTING DIFFUSORE / DIFFUSER	54x29x27 34,5x27x34,5	1 0,6	2,2 1,4
	F265805100BINE	MONTATURA / MOUNTING DIFFUSORE / DIFFUSER	54x29x27 34,5x27x34,5	1 0,6	2,2 1,4
<b>PINECONE</b>	F436405550CBNE	LAMPADA COMPLETA / COMPLETE LAMP	40x40x40	5,5	6,5
	F436405550TCNE	LAMPADA COMPLETA / COMPLETE LAMP	40x40x40	5,5	6,5
	F436405575OBNE	LAMPADA COMPLETA / COMPLETE LAMP	40x40x40	5,5	6,5

Famiglia Family	Codice Code	Descrizione Description	Dimensione Size cm A x B x H	Kg netto Kg net	Kg lordo Kg gross
	F436405575TONE	LAMPADA COMPLETA / COMPLETE LAMP	40x40x40	5,5	6,5
	F434010550CBNE	LAMPADA COMPLETA / COMPLETE LAMP	64x58x64	11	14
	F434010550TCNE	LAMPADA COMPLETA / COMPLETE LAMP	64x58x64	11	14
	F434010575OBNE	LAMPADA COMPLETA / COMPLETE LAMP	64x58x64	11	14
	F434010575TONE	LAMPADA COMPLETA / COMPLETE LAMP	64x58x64	11	14
<b>PIRELLINA</b>	F278205150KBNE	MONTATURA / MOUNTING DIFFUSORI / DIFFUSERS	21x10x43 32x16x34	1 1	1,4 1,4
<b>RE</b>	F448910100BIWL	MONTATURA / MOUNTING DIFFUSORE / DIFFUSER	41,5x41,5x72 35,5x38,5x35,5	8 2	9,5 3
<b>REGINA</b>	F448810100BIWL	MONTATURA / MOUNTING DIFFUSORI / DIFFUSERS DIFFUSORE CENTRALE/CENTRAL DIFFUSER	37,5x37,5x46 29x29x24,5 57x57x18,5	5,5 1 2,5	6,5 2 4,5
<b>SETAREH</b>	F438405500NBWL	MONTATURA / MOUNTING DIFFUSORE / DIFFUSER	27,5x80x36,5 50,5x8,5x50,5	3 0,9	4,5 2
	F438405500OBWL	MONTATURA / MOUNTING DIFFUSORE / DIFFUSER	27,5x80x36,5 50,5x8,5x50,5	3 0,9	4,5 2
<b>THOR</b>	F329500100BINE	LAMPADA COMPLETA / COMPLETE LAMP	40x21x29	1,5	2
	F329505100BINE	LAMPADA COMPLETA / COMPLETE LAMP	47x23x32	2	2,8
<b>TROPICO</b>	F442105585BIWL	MONTATURA / MOUNTING DIFFUSORE / DIFFUSER	35x35x42 44x44x21	8,7 2	10,5 3,2
	F442105585GCWL	MONTATURA / MOUNTING DIFFUSORE / DIFFUSER	35x35x42 44x44x21	8,7 2	10,5 3,2
	F442105585NEWL	MONTATURA / MOUNTING DIFFUSORE / DIFFUSER	35x35x42 44x44x21	8,7 2	10,5 3,2
	F442110585BIWL	MONTATURA / MOUNTING DIFFUSORE / DIFFUSER	47x47x48,5 56x56x21	19,5 3,5	23,5 5,5
	F442110585GCWL	MONTATURA / MOUNTING DIFFUSORE / DIFFUSER	47x47x48,5 56x56x21	19,5 3,5	23,5 5,5
	F442110585NEWL	MONTATURA / MOUNTING DIFFUSORE / DIFFUSER	47x47x48,5 56x56x21	19,5 3,5	23,5 5,5
<b>UOVO</b>	F264600100BINE	MONTATURA / MOUNTING DIFFUSORE / DIFFUSER	15x10x15 24x40x24	0,2 1	0,3 1,5
	F264605100BINE	MONTATURA / MOUNTING DIFFUSORE / DIFFUSER	15x10x15 42x50x42	0,2 2	0,3 4
	F264610100BINE	MONTATURA / MOUNTING DIFFUSORE / DIFFUSER	20x15x20 49x68x49	0,4 5,2	0,6 8,2
<b>UOVO RIC. / REC.</b>	F264600150BIBW	MONTATURA / MOUNTING DIFFUSORE / DIFFUSER	15x10x15 24x40x24	0,2 1	0,3 1,5
<b>UOVO OUTDOOR</b>	F264613370BINE	MONTATURA / MOUNTING DIFFUSORE / DIFFUSER	20x15x20 55x55x85	0,4 4,2	0,6 6
<b>DEMI VOLÉE</b>	F429000350BIWL	CORPO / BODY BASE / BASE	26x6x64 27x8x27	0,5 3	1 3,5
	F429000350GIWL	CORPO / BODY BASE / BASE	26x6x64 27x8x27	0,6 3	1 3,5
	F429000350GSWL	CORPO / BODY BASE / BASE	26x6x64 27x8x27	0,6 3	1 3,5
<b>VOLÉE</b>	F429005350BIWL	CORPO / BODY BASE / BASE	108x7x28 27x8x27	3 3	3,5 3,5
	F429005350GIWL	CORPO / BODY BASE / BASE	108x7x28 27x8x27	3 3	3,5 3,5
	F429005350GSWL	CORPO / BODY BASE / BASE	108x7x28 27x8x27	3 3	3,5 3,5

**LAMPADE DA TERRA /**  
**FLOOR LAMPS**

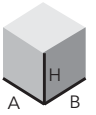

Famiglia Family	Codice Code	Descrizione Description	Dimensione Size cm A x B x H	Kg netto Kg net	Kg lordo Kg gross	
<b>3247</b>	F324725150KBNE	MONTATURA / MOUNTING DIFFUSORE / DIFFUSER	43x145x44 42x37x42	4,5 0,7	9,5 1,2	
	F324730150KBNE	MONTATURA / MOUNTING DIFFUSORE / DIFFUSER	52x186x56 54x52x54	15 4,8	23 7	
<b>BIANCA</b>	F430930150BINE	MONTATURA / MOUNTING DIFFUSORE / DIFFUSER	48x159x48 61x57x61	13,6 5	18,6 7,5	
<b>CHESHIRE</b>	F425225350BINE	LAMPADA COMPLETA / COMPLETE LAMP	50x163x49	6,6	13,3	
	F425225350NENE	LAMPADA COMPLETA / COMPLETE LAMP	50x163x49	6,7	13,4	
<b>EQUATORE</b>	F439220150OOWL	MONTATURA / MOUNTING DIFFUSORE / DIFFUSER	31,5x31,5x132 32x22,5x32	9,5 1,7	12 2,5	
	F439220550CRWL	MONTATURA / MOUNTING DIFFUSORE / DIFFUSER	31,5x31,5x132 32x22,5x32	9,5 1,7	12 2,5	
	F439220550NEWL	MONTATURA / MOUNTING DIFFUSORE / DIFFUSER	31,5x31,5x132 32x22,5x32	9,5 1,7	12 2,5	
	F439220550RSWL	MONTATURA / MOUNTING DIFFUSORE / DIFFUSER	31,5x31,5x132 32x22,5x32	9,5 1,7	12 2,5	
	F439225150OOWL	MONTATURA / MOUNTING DIFFUSORE / DIFFUSER	43,5x43,5x165 43x33,5x43	19 3,4	23 5,3	
	F439225550CRWL	MONTATURA / MOUNTING DIFFUSORE / DIFFUSER	43,5x43,5x165 43x33,5x43	19 3,4	23 5,3	
	F439225550NEWL	MONTATURA / MOUNTING DIFFUSORE / DIFFUSER	43,5x43,5x165 43x33,5x43	19 3,4	23 5,3	
	F439225550RSWL	MONTATURA / MOUNTING DIFFUSORE / DIFFUSER	43,5x43,5x165 43x33,5x43	19 3,4	23 5,3	
	<b>FLÛTE</b>	F330025150TCNE	LAMPADA COMPLETA / COMPLETE LAMP	31x202x31	6	10,1
		F330030150TCNE	MONTATURA / MOUNTING BASE / BASE	43x217x41 47x7x47	11 10	14,5 12
<b>LUMEN</b>	F248225150BINE	MONTATURA / MOUNTING DIFFUSORE / DIFFUSER	57x181x53,5 54x52x54	10,7 4,8	18 7	
<b>LUMINATOR</b>	F005630200NSWL	LAMPADA COMPLETA / COMPLETE LAMP	35,5x210x35,5	13	18,4	
	F005630210BIWL	LAMPADA COMPLETA / COMPLETE LAMP	35,5x210x35,5	13	18,4	
	F005630210BLWL	LAMPADA COMPLETA / COMPLETE LAMP	35,5x210x35,5	13	18,4	
<b>MERIDIANO</b>	F441725550NFWL	MONTATURA / MOUNTING DIFFUSORE / DIFFUSER	180x44x42 39x39x49	15 2,8	21,2 4,8	
	F441725550NRWL	MONTATURA / MOUNTING DIFFUSORE / DIFFUSER	180x44x42 39x39x49	15 2,8	21,2 4,8	
	F441725550NTWL	MONTATURA / MOUNTING DIFFUSORE / DIFFUSER	180x44x42 39x39x49	15 2,8	21,2 4,8	
<b>OORT</b>	OORT00101	LAMPADA COMPLETA / COMPLETE LAMP	120x25x10	3	4	
	OORT00102	LAMPADA COMPLETA / COMPLETE LAMP	160x25x10	3	4	
<b>PAROLA</b>	F265925100AMNE	MONTATURA / MOUNTING DIFFUSORE / DIFFUSER	20x145x35 34,5x27x34,5	4,5 0,6	6 1,4	
	F265925100BINE	MONTATURA / MOUNTING DIFFUSORE / DIFFUSER	20x145x35 34,5x27x34,5	4,5 0,6	6 1,4	
<b>PAROLONA</b>	F275130150BINE	BASE / BASE	40x40x10	4	5	
		DIFFUSORE / DIFFUSER	41x41x36	3	2	
		CORPO / BODY	15x15x220	7	9	
<b>PIRELLONE</b>	F275930150KBNE	MONTATURA / MOUNTING DIFFUSORE / DIFFUSER	48x192x48 52x20x192	12 6,7	15 11,3	
<b>PRIMA SIGNORA</b>	F289130150CBNE	MONTATURA / MOUNTING DIFFUSORE / DIFFUSER	17x14,5x160 55x55x55	6 7,5	8 10	
<b>VERTIGO</b>	F553130240CRWL	LAMPADA COMPLETA / COMPLETE LAMP	40x220x40	11	13,5	
<b>YUMI</b>	F414330900NEWL	BASE / BASE	60x10x60	18,5	20	
		CORPO / BODY	320x95x15	2,5	11	
	F414330200BIWL	BASE / BASE	60x10x60	18,5	20	
		CORPO / BODY	320x95x15	2,5	11	

**LAMPADE A PARETE E A PLAFONE /**  
**WALL AND CEILING LAMPS**



Famiglia Family	Codice Code	Descrizione Description	Dimensione Size cm A x B x H	Kg netto Kg net	Kg lordo Kg gross
<b>BIANCA</b>	F432860150BINE	LAMPADA COMPLETA / COMPLETE LAMP	21x16x21	1	1,1
	F432865150BINE	LAMPADA COMPLETA / COMPLETE LAMP	40x27,5x40	3	3,3
	F432870150BINE	LAMPADA COMPLETA / COMPLETE LAMP	61x57x61	6	8,5
<b>BONNET</b>	F443245200BILE	LAMPADA COMPLETA / COMPLETE LAMP	23x20x35	1	1,3
<b>BRUCO</b>	F353845100BINE	LAMPADA COMPLETA / COMPLETE LAMP	14,5x17x29,5	1,5	2,5
<b>FALENA</b>	F301945150CRNE	CORPO / BODY	70x10x30	0,2	1
		ATTACCO A PARETE / WALL ATTACHMENT	19,5x7,5x16,5	0,4	0,6
<b>FLEX</b>	F431045200BILE	LAMPADA COMPLETA / COMPLETE LAMP	22x16x41	1,7	2,2
	F431045200NELE	LAMPADA COMPLETA / COMPLETE LAMP	22x16x41	1,7	2,2
<b>FONTANELLA</b>	F447745550CRNE	DIFFUSORE / DIFFUSER	32,5x32,5x37,5	0,5	1
		MONTATURA / MOUNTING	15x15x11	1,5	2
	F447745550NENE	DIFFUSORE / DIFFUSER	32,5x32,5x37,5	0,5	1
		MONTATURA / MOUNTING	15x15x11	1,5	2
	F447745550OTNE	DIFFUSORE / DIFFUSER	32,5x32,5x37,5	0,5	1
		MONTATURA / MOUNTING	15x15x11	1,5	2
F447750550CRNE	DIFFUSORE / DIFFUSER	32,5x32,5x37,5	0,5	1	
	MONTATURA / MOUNTING	15x15x11	1,5	2	
F447750550NENE	DIFFUSORE / DIFFUSER	32,5x32,5x37,5	0,5	1	
	MONTATURA / MOUNTING	15x15x11	1,5	2	
F447750550OTNE	DIFFUSORE / DIFFUSER	32,5x32,5x37,5	0,5	1	
	MONTATURA / MOUNTING	15x15x11	1,5	2	
<b>FRENESI</b>	F446745550TCLE				
<b>IO</b>	F449045200BILE	LAMPADA COMPLETA / COMPLETE LAMP	14x13,5x20,5	0,4	0,5
	F449045200BSLE	LAMPADA COMPLETA / COMPLETE LAMP	14x13,5x20,5	0,4	0,5
	F449045200OLE	LAMPADA COMPLETA / COMPLETE LAMP	14x13,5x20,5	0,4	0,5
	F449045200BLLE	LAMPADA COMPLETA / COMPLETE LAMP	14x13,5x20,5	0,4	0,5
	F449045200GSLE	LAMPADA COMPLETA / COMPLETE LAMP	14x13,5x20,5	0,4	0,5
	F449045200ROLE	LAMPADA COMPLETA / COMPLETE LAMP	14x13,5x20,5	0,4	0,5
<b>LUNAIRE</b>	F424665360ONLE	MONTATURA / MOUNTING	86x20x86	6,8	10,5
		TAPPO / PLUG	45x30x45	1,5	2,3
	F424665360RNLE	MONTATURA / MOUNTING	86x20x86	5,3	9
		TAPPO / PLUG	45x30x45	1,5	2,3
	F424665350BILE	LAMPADA COMPLETA / COMPLETE LAMP	86x20x86	6,8	10,5
F424665350NELE	LAMPADA COMPLETA / COMPLETE LAMP	86x20x86	6,8	10,5	
F424660350BILE	LAMPADA COMPLETA / COMPLETE LAMP	56x57x16,5	2	4,5	
<b>NASKA</b>	F810340200BINE	CORPO / BODY	23x38x20	1,9	2,5
		ATTACCO A PARETE / WALL ATTACHMENT	13x9x15	0,2	0,3
	F810340200NENE	CORPO / BODY	23x38x20	1,9	2,5
		ATTACCO A PARETE / WALL ATTACHMENT	13x9x15	0,2	0,3
	F810340240CRNE	CORPO / BODY	23x38x20	1,9	2,5
		ATTACCO A PARETE / WALL ATTACHMENT	13x9x15	0,2	0,3
F810350200BINE	CORPO / BODY	18x67x28	2,8	3,5	
	ATTACCO A PARETE / WALL ATTACHMENT	13x9x15	0,2	0,3	
F810350200NENE	CORPO / BODY	18x67x28	2,8	3,5	
	ATTACCO A PARETE / WALL ATTACHMENT	13x9x15	0,2	0,3	
F810350240CRNE	CORPO / BODY	18x67x28	2,8	3,5	
	ATTACCO A PARETE / WALL ATTACHMENT	13x9x15	0,2	0,3	
<b>NOBI</b>	F302345150BINE	LAMPADA COMPLETA / COMPLETE LAMP	44,5x17x13,5	0,5	0,9
	F302345150CRLE	LAMPADA COMPLETA / COMPLETE LAMP	44,5x17x13,5	0,5	0,9
	F302345150NSLE	LAMPADA COMPLETA / COMPLETE LAMP	44,5x17x13,5	0,5	0,9
<b>PALLINA</b>	F443060150NENE	LAMPADA COMPLETA / COMPLETE LAMP	19x19x19	1	1,5
	F443060150NSNE	LAMPADA COMPLETA / COMPLETE LAMP	19x19x19	1	1,5
	F443060150OTNE	LAMPADA COMPLETA / COMPLETE LAMP	19x19x19	1	1,5
<b>PANGEN</b>	F419766350BINE	LAMPADA COMPLETA / COMPLETE LAMP	67x30x67	3,5	4,5
	F419766350NENE	LAMPADA COMPLETA / COMPLETE LAMP	67x30x67	3,5	4,5
	F419766350RONE	LAMPADA COMPLETA / COMPLETE LAMP	67x30x67	3,5	4,5
<b>RIGA</b>	F521440250BILE	LAMPADA COMPLETA / COMPLETE LAMP	14,5x14,5x43	1,1	1,3
	F521440260NSLE	LAMPADA COMPLETA / COMPLETE LAMP	14,5x14,5x43	1,1	1,3
	F521450250BILE	LAMPADA COMPLETA / COMPLETE LAMP	16x14x80	2,2	2,5

Famiglia Family	Codice Code	Descrizione Description	Dimensione Size cm A x B x H	Kg netto Kg net	Kg lordo Kg gross
	F521450260NSLE	LAMPADA COMPLETA / COMPLETE LAMP	16x14x80	2,2	2,5
	F539845250BILE	LAMPADA COMPLETA / COMPLETE LAMP	13x13x60	1,8	2,5
	F539845260NSLE	LAMPADA COMPLETA / COMPLETE LAMP	13x13x60	1,8	2,5
	F521440250BINE	LAMPADA COMPLETA / COMPLETE LAMP	14,5x14x43	1,1	1,3
<b>SCINTILLA</b>	FP15045250CRNE	LAMPADA COMPLETA / COMPLETE LAMP	28x26x20	0,4	0,9
	FP15045250NSNE	LAMPADA COMPLETA / COMPLETE LAMP	20x28x26	0,4	1,8
	FP30050250CRNE	LAMPADA COMPLETA / COMPLETE LAMP	28x26x20	0,4	0,9
	FP30050250NSNE	LAMPADA COMPLETA / COMPLETE LAMP	28x26x20	0,4	0,9
<b>SILLABA</b>	F277560150BINE	LAMPADA COMPLETA / COMPLETE LAMP	19x12x18	0,2	0,5
	F277570150BILE	LAMPADA COMPLETA / COMPLETE LAMP	20,8x13x22,6	0,7	1
	F277570150BINE	LAMPADA COMPLETA / COMPLETE LAMP	21x13x23	0,6	0,9
<b>SOLE</b>	F413940150BILE	LAMPADA COMPLETA / COMPLETE LAMP	15x18x60	3,0	3,0
	F414040150BILE	LAMPADA COMPLETA / COMPLETE LAMP	13x6x16	1,0	1,5
<b>TROPICO</b>	F442160550NELE	MONTATURA / MOUNTING DIFFUSORE / DIFFUSER	32x32x16 32x32x16	1 1	1,7 1,7
	F442160550OOLE	MONTATURA / MOUNTING DIFFUSORE / DIFFUSER	32x32x16 32x32x16	1 1	1,7 1,7
	F442165550NELE	MONTATURA / MOUNTING DIFFUSORE / DIFFUSER	44x44x21 44x44x21	2 2	3,4 3,4
	F442165550OOLE	MONTATURA / MOUNTING DIFFUSORE / DIFFUSER	44x44x21 44x44x21	2 2	3,4 3,4
	F442170550NELE	MONTATURA / MOUNTING DIFFUSORE / DIFFUSER	56x56x21 56x56x21	3,7 3,7	5,8 5,8
	F442170550OOLE	MONTATURA / MOUNTING DIFFUSORE / DIFFUSER	56x56x21 56x56x21	3,7 3,7	5,8 5,8



# LAMPADE A SOSPENSIONE / SUSPENSION LAMPS

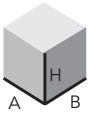

Famiglia Family	Codice Code	Descrizione Description	Dimensione Size cm A x B x H	Kg netto Kg net	Kg lordo Kg gross
<b>0024</b>	F002485150TRNE	MONTATURA / MOUNTING DIFFUSORE / DIFFUSER	36x36x70,5 62x20x62	5 17	6 20
	<b>AMAX</b>	F544480350BINE	LAMPADA COMPLETA / COMPLETE LAMP	35x50x35	2,2
	F544485350BINE	LAMPADA COMPLETA / COMPLETE LAMP	55x50x55	3,7	5,9
	F544490350BINE	LAMPADA COMPLETA / COMPLETE LAMP	85,5x76x85,5	12	22
	F544495350BINE	LAMPADA COMPLETA / COMPLETE LAMP	110x98x110	17,5	33,5
<b>AVICO</b>	F556180350BINE	LAMPADA COMPLETA / COMPLETE LAMP	125,5x66,5x125,5	20	30
	F556180375NENE	LAMPADA COMPLETA / COMPLETE LAMP	125,5x66,5x125,5	20	30
	F556185350BINE	LAMPADA COMPLETA / COMPLETE LAMP	165x96x165	30	45
	F556185375NENE	LAMPADA COMPLETA / COMPLETE LAMP	165x96x165	30	45
<b>BIANCA</b>	F430680150BINE	MONTATURA / MOUNTING DIFFUSORE / DIFFUSER	20x15x20 40x27,5x40	1 1,8	1,2 2,1
	F430685150BINE	LAMPADA COMPLETA / COMPLETE LAMP	21x16x21	1	1,2
	F430690150BINE	LAMPADA COMPLETA / COMPLETE LAMP	61x57x61	6	8,5
<b>BOLLA</b>	F354085100TRNE	MONTATURA / MOUNTING DIFFUSORE / DIFFUSER	22x15x20 40x40x40	0,7 3	1,5 4
	F354090100TRNE	MONTATURA / MOUNTING DIFFUSORE / DIFFUSER	22x15x20 65x40x40	0,7 3,5	1,5 4,5
<b>CHANDELIER</b>	F549180250NBNE	LAMPADA COMPLETA / COMPLETE LAMP	90x20x90	13	14,5
	F549180260OBNE	LAMPADA COMPLETA / COMPLETE LAMP	90x20x90	13	14,5
	F549185250NBNE	LAMPADA COMPLETA / COMPLETE LAMP	170x20x170	18	25
	F549185260OBNE	LAMPADA COMPLETA / COMPLETE LAMP	170x20x170	18	25
	F549190250NBNE	LAMPADA COMPLETA / COMPLETE LAMP	100x20x100	19	21
	F549190260OBNE	LAMPADA COMPLETA / COMPLETE LAMP	100x20x100	19	21
	F549195250NBNE	LAMPADA COMPLETA / COMPLETE LAMP	157x20x157	31	35
	F549195260OBNE	LAMPADA COMPLETA / COMPLETE LAMP	157x20x157	31	35
<b>EQUATORE</b>	F439085150OOLE	MONTATURA / MOUNTING DIFFUSORE / DIFFUSER	43x76x43 43x33,5x43	7,4 3,4	10 5,3
	F439085550CRLE	MONTATURA / MOUNTING DIFFUSORE / DIFFUSER	43x76x43 43x33,5x43	7,4 3,4	10 5,3
	F439085550NELE	MONTATURA / MOUNTING DIFFUSORE / DIFFUSER	43x76x43 43x33,5x43	7,4 3,4	10 5,3
	F439085550RSLE	MONTATURA / MOUNTING DIFFUSORE / DIFFUSER	43x76x43 43x33,5x43	7,4 3,4	10 5,3
	F439090150OOLE	MONTATURA / MOUNTING DIFFUSORE / DIFFUSER	61x90x61 32x22,5x32	12,5 1,7	18,8 2,5
	F439090550CRLE	MONTATURA / MOUNTING DIFFUSORE / DIFFUSER	61x90x61 61x47x61	12,5 4,5	18,8 7,6
	F439090550NELE	MONTATURA / MOUNTING DIFFUSORE / DIFFUSER	61x90x61 61x47x61	12,5 4,5	18,8 7,6
	F439090550RSLE	MONTATURA / MOUNTING DIFFUSORE / DIFFUSER	61x90x61 61x47x61	12,5 4,5	18,8 7,6
<b>FONTANELLA</b>	F447890550NENE	MONTATURA / MOUNTING DIFFUSORE / DIFFUSER	23x23x54,5 48,5x48,5x27,5	2 0,5	3 1
	F447890550OTNE	MONTATURA / MOUNTING DIFFUSORE / DIFFUSER	23x23x54,5 48,5x48,5x27,5	2 0,5	3 1
	F447885550NENE	MONTATURA / MOUNTING DIFFUSORE / DIFFUSER	23x23x54,5 32,5x32,5x27,5	3 0,5	4 1
	F447885550OTNE	MONTATURA / MOUNTING DIFFUSORE / DIFFUSER	23x23x54,5 32,5x32,5x27,5	3 0,5	4 1
<b>FLÔTE</b>	F333780150TCNE	LAMPADA COMPLETA / COMPLETE LAMP	45x28x27	1	1,7
	F333780550NENE	LAMPADA COMPLETA / COMPLETE LAMP	45x28x27	1	1,7
	F333780550RMNE	LAMPADA COMPLETA / COMPLETE LAMP	45x28x27	1	1,7
	F333795150TCNE	LAMPADA COMPLETA / COMPLETE LAMP	85x28x27	2,2	3,6
	F333790550TCNE	LAMPADA COMPLETA / COMPLETE LAMP	135x26x25	3,5	5
<b>GLOBO DI LUCE</b>	F364480150CRNE	LAMPADA COMPLETA / COMPLETE LAMP	26,5x23,5x26,5	1,3	1,9
	F364480150RMNE	LAMPADA COMPLETA / COMPLETE LAMP	26,5x23,5x26,5	1,3	1,9
	F364485150CRNE	LAMPADA COMPLETA / COMPLETE LAMP	40x40x40	2	3,1
	F364485150RMNE	LAMPADA COMPLETA / COMPLETE LAMP	40x40x40	2	3,1
	F364490150CRNE	LAMPADA COMPLETA / COMPLETE LAMP	60x60x60	5	7
	F364490150RMNE	LAMPADA COMPLETA / COMPLETE LAMP	60x60x60	5	7

Famiglia Family	Codice Code	Descrizione Description	Dimensione Size cm A x B x H	Kg netto Kg net	Kg lordo Kg gross
<b>HUNA</b>	F505985200NENE	LAMPADA COMPLETA / COMPLETE LAMP	53x38x53	1,7	2,5
<b>LAMPARA</b>	F500090200ALNE	LAMPADA COMPLETA / COMPLETE LAMP	47x60x47	2	2,8
	F500090220BINE	LAMPADA COMPLETA / COMPLETE LAMP	47x60x47	2	2,8
<b>MERIDIANO</b>	F441785550NFLE	MONTATURA / MOUNTING DIFFUSORE / DIFFUSER	23x23x54,5 39x39x49	3 2,8	4 4,8
	F441790550NFLE	MONTATURA / MOUNTING DIFFUSORE / DIFFUSER	23x23x68 48,5x48,5x63	4,1 6	5,4 9
<b>OORT</b>	OORT00103	MONTATURA / MOUNTING DIFFUSORE / DIFFUSER	23x21x10,5 149,5x16,5x10	0,7 1,7	0,9 2,7
	OORT00104	MONTATURA / MOUNTING DIFFUSORE / DIFFUSER	28x30x11,5 179,5x16,5x10	1,6 2	2 3,5
	OORT00105	MONTATURA / MOUNTING DIFFUSORE / DIFFUSER	28x30x11,5 70,5x16,5x10	1,6 1	2 1,4
	OORT00106	MONTATURA / MOUNTING DIFFUSORE / DIFFUSER	28x30x11,5 149,5x16,5x10	1,6 1,5	2 2,5
	OORT00107	MONTATURA / MOUNTING DIFFUSORE / DIFFUSER	28x30x11,5 179,5x16,5x10	1,6 2	2 3,5
<b>PALLINA</b>	F443080150ORNE	LAMPADA COMPLETA / COMPLETE LAMP	19x19x42	1,5	2
	F443080150NENE	LAMPADA COMPLETA / COMPLETE LAMP	19x19x42	1,5	2
	F443080150NSNE	LAMPADA COMPLETA / COMPLETE LAMP	19x19x42	1,5	2
<b>PANGEN</b>	F419685350BINE	LAMPADA COMPLETA / COMPLETE LAMP	67x30x67	3,5	4,5
	F419685350NENE	LAMPADA COMPLETA / COMPLETE LAMP	67x30x67	3,5	4,5
	F419685350ORONE	LAMPADA COMPLETA / COMPLETE LAMP	67x30x67	3,5	4,5
<b>PAROLA</b>	F428485100AMNE	MONTATURA / MOUNTING DIFFUSORE / DIFFUSER	13,5x12,5x13,5 41x36x41	0,3 2	0,4 3
	F428485100BINE	MONTATURA / MOUNTING DIFFUSORE / DIFFUSER	13,5x12,5x13,5 41x36x41	0,3 2	0,4 3
<b>PINECONE</b>	F433990550CBNE	LAMPADA COMPLETA / COMPLETE LAMP	64x58x64	11	14
	F433990550TCNE	LAMPADA COMPLETA / COMPLETE LAMP	64x58x64	11	14
	F433990575OBNE	LAMPADA COMPLETA / COMPLETE LAMP	65x58x65	11	14
	F433990575TONE	LAMPADA COMPLETA / COMPLETE LAMP	64x58x64	11	14
	F436385550CBNE	LAMPADA COMPLETA / COMPLETE LAMP	40x40x40	5,5	6,5
	F436385550TCNE	LAMPADA COMPLETA / COMPLETE LAMP	40x40x40	5,5	6,5
	F436385575OBNE	LAMPADA COMPLETA / COMPLETE LAMP	40x40x40	5,5	6,5
	F436385575TONE	LAMPADA COMPLETA / COMPLETE LAMP	40x40x40	5,5	6,5
<b>SCINTILLA</b>	FS30090250CRNE	LAMPADA COMPLETA / COMPLETE LAMP	36x15x26	0,6	1
	FS30090250NSNE	LAMPADA COMPLETA / COMPLETE LAMP	14x36x26	0,5	0,9
<b>SETAREH</b>	F438G85550NBLE	MONTATURA / MOUNTING DIFFUSORE / DIFFUSER	25x80,5x25 70,5x8,5x70,5	2 2,2	3,5 4,5
	F438G85550OBLE	MONTATURA / MOUNTING DIFFUSORE / DIFFUSER	25x80,5x25 70,5x8,5x70,5	2 2,2	3,5 4,5



Famiglia Family	Codice Code	Descrizione Description	Dimensione Size cm A x B x H	Kg netto Kg net	Kg lordo Kg gross
<b>CARTOCCIO</b>	F2910VA100OP10	VASO / VASE	39x30x39	4,5	5,5
	F2920VA100TR20	VASO / VASE	39,5x36,5x39,5	4,5	5,5
	F3010VA100TR10	VASO / VASE	39,5x36,5x39,5	4,5	5,5
<b>FONTANA (TAVOLO / TABLE)</b>	F2600TB100TR00	TAVOLO / TABLE	70x50x50	21	40
	F2610TB100TR10	TAVOLO / TABLE	130x50x70	36	60
	F2620TB100TR20	TAVOLO / TABLE	150x50x80	57	90
<b>FONTANA (VASO / VASE)</b>	F1800VA100BO00	VASO / VASE			
	F1900VA100BO00	SET 4 VASI / VASE SET			
<b>TAVOLINO 1932</b>	F2710TB150TR10	PIANO / TOP	72x15x72	10	12
		STRUTTURA / STRUCTURE	73x18x73	18	20
<b>TAVOLO CON RUOTE</b>	F1000TB150TR00	PIANO / TOP	80x10x150	24	34
		RUOTE / WHEELS	35x20x50	12	13
	F1010TB150TR10	PIANO / TOP	160x10x110	52	62
		RUOTE / WHEELS	35x20x50	12	13
	F1110TB150TR00	PIANO / TOP	110x10x110	34,5	44,5
		RUOTE / WHEELS	35x20x50	12	13
	F1120TB150TR20	PIANO / TOP	120x10x120	42	52
RUOTE / WHEELS		35x20x50	12	13	
F1130TB150TR30	PIANO / TOP	130x10x130	52	61	
	RUOTE / WHEELS	35x20x50	12	13	
F1140TB150TR40	PIANO / TOP	160x10x160	81	91	
	RUOTE / WHEELS	35x20x50	12	13	
<b>TESO (TAVOLO / TABLE)</b>	F2720TA150TR20	PIANO / TOP	95x10x230	100	120
		RUOTE / WHEELS	85x30x100	35	45
<b>TESO (LIBRERIA / BOOKCASE)</b>	F2720L150TR20	STRUTTURA / STRUCTURE	50x7x60	5	6
		MENSOLE / SHELVES	45x20x250	85	100
		MONTANTI / UPRIGHTS	45x50x45	30	35
F2720CO150TR20	STRUTTURA / STRUCTURE	23x8x50	4	5	
	MENSOLE / SHELVES	45x12x250	65	80	
	MONTANTI / UPRIGHTS	35x20x45	10	15	
<b>TOUR</b>	F3010TA150TR10	PIANO / TOP	125x5x125	57	58
		RUOTE / WHEELS	55x50x55	15	16

**SEDE / HEADQUARTERS**

**FONTANAARTE SPA**

Alzaia Trieste 49

I-20094 Corsico (MI)

Ph. +39 02 45121

Fax +39 02 4512660 / 990

info@fontanaarte.com

P.I.: 09632850963

www.fontanaarte.com

Instagram: fontanaarte

FontanaArte è azienda certificata  
ISO 9001:2015 con DNV - GL. Certificato  
nr. 178796-2015-AQ-ITA-ACCREDIA

FontanaArte has ISO 9001:2015  
certification from the DNV - GL. Certificate  
no. 178796-2015-AQ-ITA-ACCREDIA

1998  
ADI Compasso d'Oro  
Career Award



Membro di  
Member of



Dal 1992 Fondazione Altagamma  
riunisce i marchi dell'eccellenza italiana  
famosi a livello internazionale.  
Since 1992 the Altagamma Foundation  
has gathered together high-end Italian  
brands famous at international level.