

LODES

P.	PRODUCT NAME
	Suspension lamps:
003	Cima
004	Elara
005	IVY V
007	JIM
008	Kelly dome
009	Kelly sphere
010	Random Cloud
014	Random Stick NEW LAMP
020	Sky-Fall
021	Sky-Fall Round
022	Tidal NEW LAMP
024	Volum 42
	Cluster suspension lamps:
027	A-Tube
028	A-Tube Nano
029	A-Tube Nano Duo
030	Cono di Luce
031	IVY I
032	Jefferson
033	JIM
034	Kelly Cluster
034	Nostalgia
036	Oblò NEW LAMP
037	Rain
038	Random
039	Random Solo
042	Spider
043	Volum 14, 22, 29
	Canopies:
045	Single Systems
047	Multiple Systems

P.	PRODUCT NAME
	Wall & Ceiling lamps:
056	Aile
053	A-Tube
054	A-Tube Nano Swing NEW LAMP
056	Bugia
058	Laser
059	Nautilus
060	Nautilus Mini
061	Nautilus Spot
061	Pin-Up
063	Puzzle
064	Puzzle Mega
062	Puzzle Round
070	Shift NEW LAMP
067	Spider
068	Tidal 45, 75 NEW LAMP
068	Tidal 60
071	Volum
	Floor & Table lamps:
079	Blow
075	Cima
079	Cono di Luce
076	Croma
080	Easy Peasy
077	Flar
078	Hover
081	Volum table
082	Volum floor NEW LAMP
084	Accessories

Lodes Price List

ED. 2025

Suspension lamps

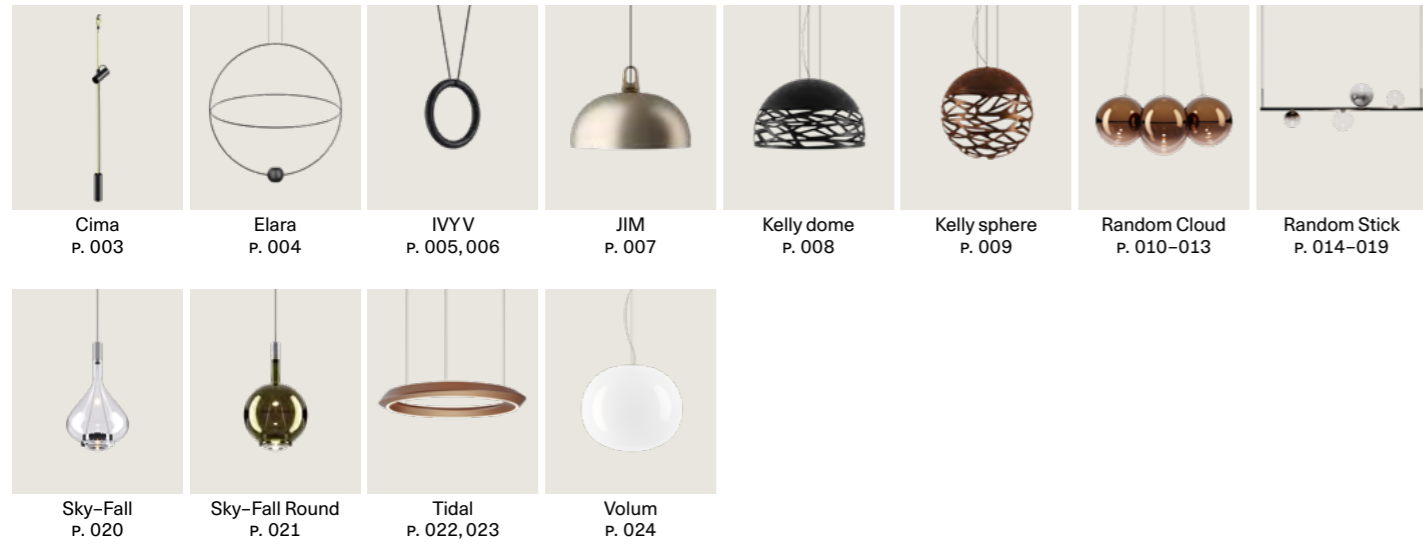

CATEGORY **SUSPENSION LAMP** FLOOR LAMP

Cima

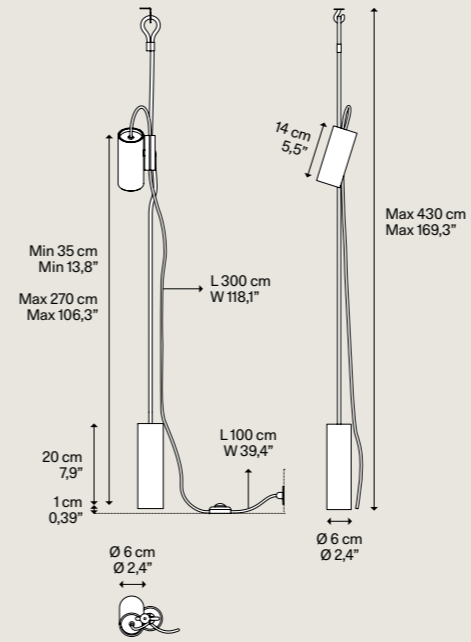

DESIGN Marco Dessì, 2021

VAT excluded
IVA esclusa

Metal structure
Montatura in metallo

Rope
Corda

Code
Codice

Euro €

● Matte Black
Nero Opaco

● Silver
Argento

17371 4100 304,00

● Gold
Oro

17371 5000 304,00

● Yellow
Giallo

17371 5100 304,00

Light source
Sorgente luminosa

GU10 Par 16 LED 1 × 10 W W/L max 9 cm W/L max 3,54"

Bulb and dimmer not included
Lampadina e dimmer non inclusi

VAT excluded
IVA esclusa

Description
Descrizione

Metal structure
Montatura in metallo

Code
Codice

Euro €

Additional kit (max 1 additional kit)

● Matte Black
Nero Opaco

17371K 2000 199,00

Light source
Sorgente luminosa

GU10 Par 16 LED 1 × 10 W W/L max 9 cm W/L max 3,54"

Bulb and dimmer not included
Lampadina e dimmer non inclusi

Net weight 1,75 kg
Peso netto 3,86 lbs Pack Colli 1



Adjustable light
Luce orientabile

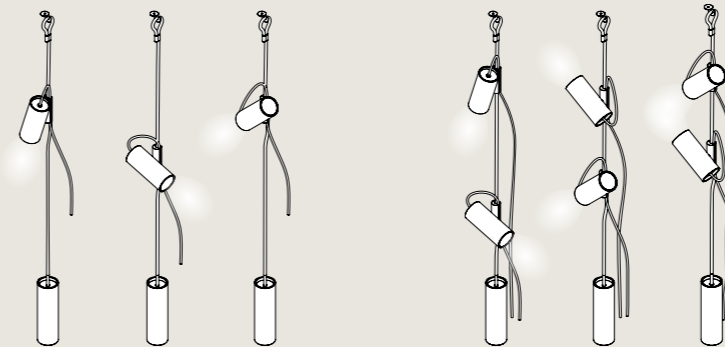

SUSPENSION LAMP
CLUSTER SUSPENSION LAMP
CANOPY
WALL & CEILING LAMP
FLOOR & TABLE LAMP
ACCESSORY

Elara medium

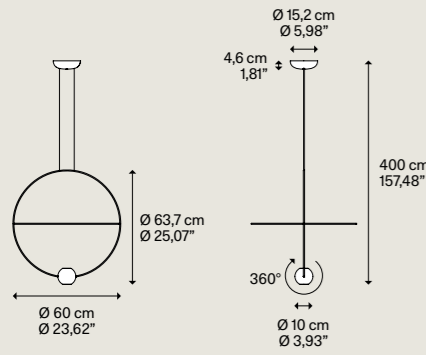

Metal structure
Montatura in metallo

- Glossy Black
Nero Lucido
- Glossy Gold
Oro Lucido

Metal sphere
Sfera in metallo

- Extra Matte Black
Nero Extra Opaco
- Matte Gold
Oro Opaco

Code
Codice

- 20621 2227
- 20621 5027

Code
Codice

- 20621 2230
- 20621 5030

Euro €

- 663,00
- 796,00

Light source
Sorgente luminosa

- LED**
- 2700 K
 - 18+9 W
 - 2100 lm-side I
 - 800 lm-side II
 - 1000 mA
 - CRI 90
 - MacAdam 3-Step

LED and driver included
LED e driver inclusi

Light source
Sorgente luminosa

- LED**
- 3000 K
 - 18+9 W
 - 2260 lm-side I
 - 845 lm-side II
 - 1000 mA
 - CRI 90
 - MacAdam 3-Step

LED and driver included
LED e driver inclusi

Net weight Peso netto	1,67 kg 3,68 lbs	Pack Colli	1	Energy class Classe energetica	2700 K ▶ D+E 3000 K ▶ D+F
--------------------------	---------------------	---------------	---	-----------------------------------	------------------------------

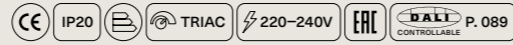

Elara large

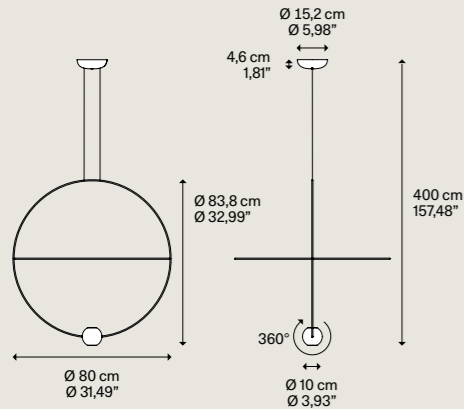

Metal structure
Montatura in metallo

- Glossy Black
Nero Lucido
- Glossy Gold
Oro Lucido

Metal sphere
Sfera in metallo

- Extra Matte Black
Nero Extra Opaco
- Matte Gold
Oro Opaco

Code
Codice

- 20622 2227
- 20622 5027

Code
Codice

- 20622 2230
- 20622 5030

Euro €

- 806,00
- 969,00

Light source
Sorgente luminosa

- LED**
- 2700 K
 - 18+9 W
 - 2100 lm-side I
 - 800 lm-side II
 - 1000 mA
 - CRI 90
 - MacAdam 3-Step

LED and driver included
LED e driver inclusi

Light source
Sorgente luminosa

- LED**
- 3000 K
 - 18+9 W
 - 2260 lm-side I
 - 845 lm-side II
 - 1000 mA
 - CRI 90
 - MacAdam 3-Step

LED and driver included
LED e driver inclusi

Net weight Peso netto	1,87 kg 4,12 lbs	Pack Colli	1	Energy class Classe energetica	2700 K ▶ D+E 3000 K ▶ D+F
--------------------------	---------------------	---------------	---	-----------------------------------	------------------------------



Adjustable light
Luce orientabile

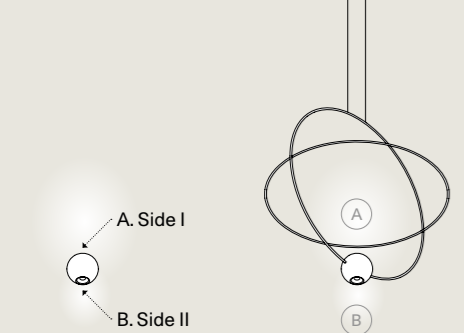

Adjustable ring
Anello orientabile

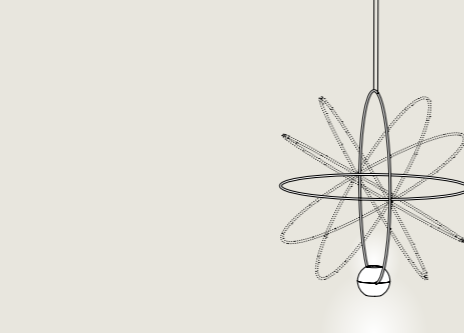

IVY V

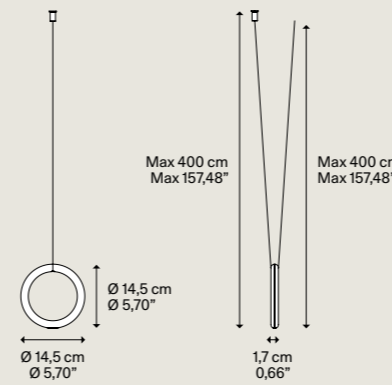

Metal structure
Montatura in metallo

- Matte Black-9005
Nero Opaco-9005
- Extra Matte Champagne
Champagne Extra Opaco
- Terra
Terra

Cable
Cavo

- Black
Nero

Code
Codice

- 17820 2020
- 17820 4520
- 17820 6720

Code
Codice

- 17820 2035
- 17820 4535
- 17820 6735

Euro €

- 199,00
- 210,00
- 220,00

Light source
Sorgente luminosa

- LED**
- 2700 K
 - 3 W
 - 450 lm
 - 350 mA
 - CRI 90
 - MacAdam 3-Step

LED and driver included
LED e driver inclusi

Light source
Sorgente luminosa

- LED**
- 3000 K
 - 3 W
 - 480 lm
 - 350 mA
 - CRI 90
 - MacAdam 3-Step

LED and driver included
LED e driver inclusi

Net weight Peso netto	0,58 kg 1,27 lbs	Pack Colli	1	Energy class Classe energetica	2700 K ▶ D 3000 K ▶ C
--------------------------	---------------------	---------------	---	-----------------------------------	--------------------------



IVY V cluster suspension lamps must only be installed on the single and central canopies below
Le lampade a sospensione cluster IVY V devono essere installate solamente sui rosoni singoli e centrali di seguito

Single Mini

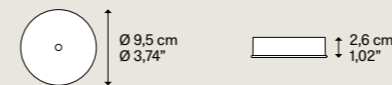

Description
Descrizione

Single ceiling canopy
small size
Rosone per lampada
singola versione mini

Methacrylate structure
Struttura in metacrilato

- Matte Black-9005
Nero Opaco-9005

System
Sistema

Single

Code
Codice

R11L01 2000

Euro €

43,00

Net weight Peso netto	0,13 kg 0,28 lbs	Pack Colli	1
--------------------------	---------------------	---------------	---



Recessed Micro

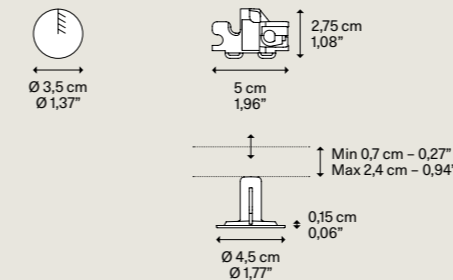

Description
Descrizione

Recessed canopy for
single lamp max capacity
3,5 kg - 7,71 lbs
Rosone da incasso per
lampada singola portata
max 3,5 kg - 7,71 lbs

Methacrylate structure
Struttura in metacrilato

- Matte Black-9005
Nero Opaco-9005

System
Sistema

Recessed

Code
Codice

R01L01 2000

Euro €

26,00

Net weight Peso netto	0,015 kg 0,033 lbs	Pack Colli	1
--------------------------	-----------------------	---------------	---



CATEGORY RECESSED CANOPY

Recessed Micro Trimless

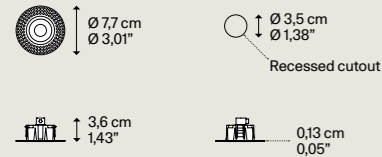

Description
Descrizione

Recessed canopy Trimless available in Pure and Deep versions for single lamp.

Methacrylate structure
Struttura in metacrilato

● Matte Black - 9005
Nero Opaco - 9005

System
Sistema

Recessed

Code
Codice

R13L01 2000

Euro €

28,00

VAT excluded
IVA esclusa

Rosone da incasso a scomparsa (Trimless) in versione Pure e Deep per lampada singola.

Net weight 0,12 kg
Peso netto 0,26 lbs

Pack Colli 1



CATEGORY CENTRAL CANOPY

6 Lights Central

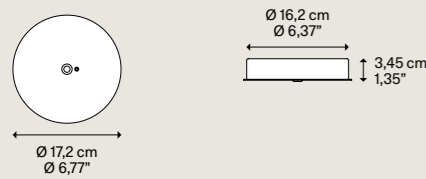

Description
Descrizione

Central canopy max 6 suspension

Methacrylate structure
Struttura in metacrilato

● Matte Black - 9005
Nero Opaco - 9005

System
Sistema

Cluster Central

Code
Codice

R07L06 2000

Euro €

148,00

VAT excluded
IVA esclusa

Rosone centrale max 6 sospensioni

Net weight 0,58 kg
Peso netto 1,27 lbs

Pack Colli 1



12 Lights Central

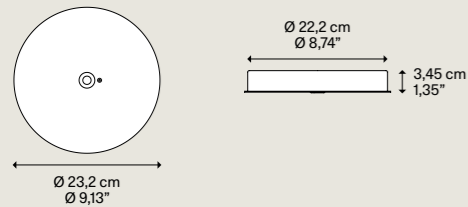

Description
Descrizione

Central canopy max 12 suspension

Methacrylate structure
Struttura in metacrilato

● Matte Black - 9005
Nero Opaco - 9005

System
Sistema

Cluster Central

Code
Codice

R07L12 2000

Euro €

194,00

VAT excluded
IVA esclusa

Rosone centrale max 12 sospensioni

Net weight 1,00 kg
Peso netto 2,20 lbs

Pack Colli 1



CATEGORY SUSPENSION LAMP

JIM dome

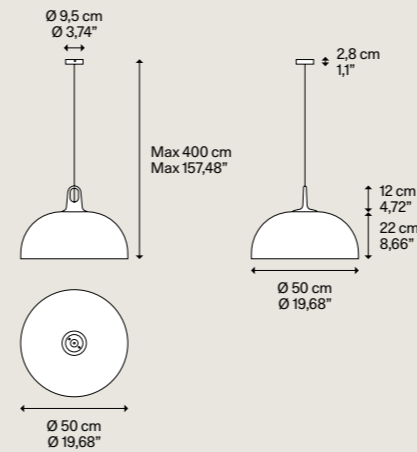

Net weight 2,20 kg
Peso netto 4,85 lbs

Pack Colli 2

DESIGN Patrick Norguet, 2021

VAT excluded
IVA esclusa

Outside metal diffuser
Diff. esterno in metallo

● Matte Black - 9005
Nero Opaco - 9005

Inside metal diffuser
Diff. interno in metallo

● Matte White - 9010
Bianco Opaco - 9010

Hook methacrylate
Gancio in metacrilato

● Grey Grigio

● Honey Miele

● Grey Grigio

● Honey Miele

Code
Codice

16924 2800

16924 6600

16924 2700

16924 6500

Euro €

516,00

516,00

526,00

526,00

Light source
Sorgente luminosa

E27 A60 LED
1x Max 25 W

Bulb not included
Lampadina non inclusa



Recessed Micro ▶ Suitable for ceilings up to 2,4 cm - 0,94" thickness.

Recessed Micro ▶ Adatta per soffitti fino a 2,4 cm - 0,94" di spessore.

Kelly small dome 50

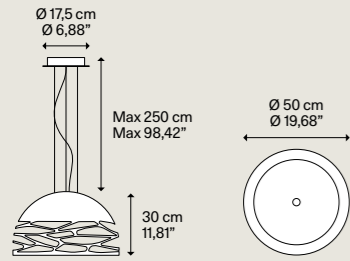

Net weight 6,00 kg / 13,23 lbs
Pack Colli 1

Metal structure Montatura in metallo	Glass diffuser Diffusore in vetro	Code Codice	Euro €
Matte White - 9010 Bianco Opaco - 9010		14126 1000	572,00
Matte Black - 9005 Nero Opaco - 9005		14126 2000	572,00
Coppery Bronze Bronzo Ramato	Glossy White Bianco Lucido	14126 3500	607,00
Champagne Champagne		14126 4500	607,00

**Light source
Sorgente luminosa**
E27 LED 3x 25 W
W/L max 12 cm / W/L max 4,72"
Bulb not included
Lampadina non inclusa

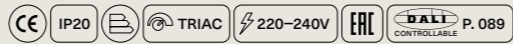

Kelly small sphere 40

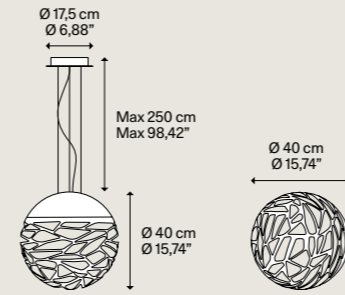

Net weight 5,50 kg / 12,13 lbs
Pack Colli 2

Metal structure Montatura in metallo	Glass diffuser Diffusore in vetro	Code Codice	Euro €
Matte White - 9010 Bianco Opaco - 9010		14122 1000	913,00
Coppery Bronze Bronzo Ramato	Glossy White Bianco Lucido	14122 3500	939,00

**Light source
Sorgente luminosa**
E27 LED 3x 25 W
W/L max 12 cm / W/L max 4,72"
Bulb not included
Lampadina non inclusa

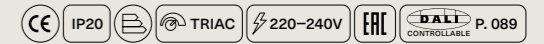

Kelly medium dome 60

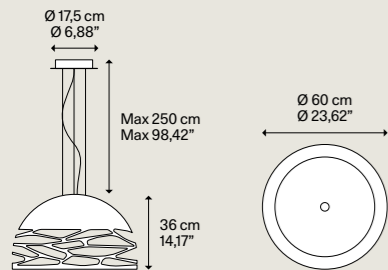

Net weight 7,15 kg / 15,75 lbs
Pack Colli 1

Metal structure Montatura in metallo	Glass diffuser Diffusore in vetro	Code Codice	Euro €
Matte White - 9010 Bianco Opaco - 9010		14127 1000	883,00
Matte Black - 9005 Nero Opaco - 9005		14127 2000	883,00
Coppery Bronze Bronzo Ramato	Glossy White Bianco Lucido	14127 3500	913,00
Champagne Champagne		14127 4500	913,00

**Light source
Sorgente luminosa**
E27 LED 3x 25 W
W/L max 12 cm / W/L max 4,72"
Bulb not included
Lampadina non inclusa

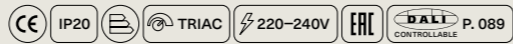

Kelly medium sphere 50

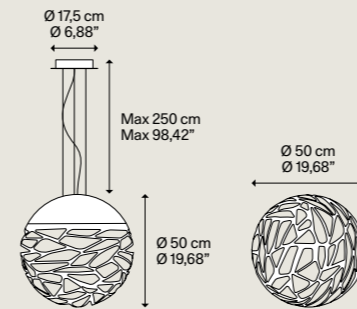

Net weight 9,00 kg / 19,84 lbs
Pack Colli 2

Metal structure Montatura in metallo	Glass diffuser Diffusore in vetro	Code Codice	Euro €
Matte White - 9010 Bianco Opaco - 9010		14123 1000	1214,00
Coppery Bronze Bronzo Ramato	Glossy White Bianco Lucido	14123 3500	1240,00

**Light source
Sorgente luminosa**
E27 LED 3x 25 W
W/L max 12 cm / W/L max 4,72"
Bulb not included
Lampadina non inclusa

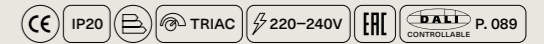

Kelly large dome 80

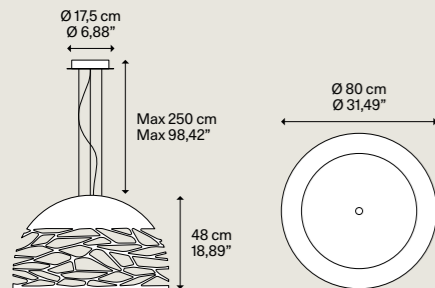

Net weight 11,00 kg / 24,25 lbs
Pack Colli 1

Metal structure Montatura in metallo	Glass diffuser Diffusore in vetro	Code Codice	Euro €
Matte White - 9010 Bianco Opaco - 9010		14128 1000	1102,00
Matte Black - 9005 Nero Opaco - 9005		14128 2000	1102,00
Coppery Bronze Bronzo Ramato	Glossy White Bianco Lucido	14128 3500	1153,00
Champagne Champagne		14128 4500	1153,00

**Light source
Sorgente luminosa**
E27 LED 3x 25 W
W/L max 12 cm / W/L max 4,72"
Bulb not included
Lampadina non inclusa



Kelly large sphere 80 *

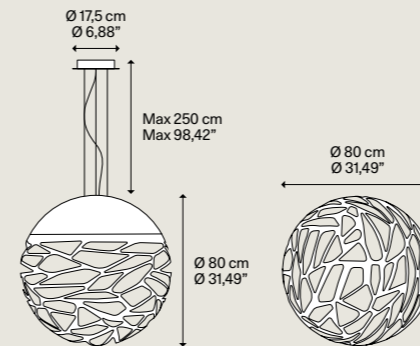

Net weight 15,00 kg / 33,07 lbs
Pack Colli 2

Metal structure Montatura in metallo	Glass diffuser Diffusore in vetro	Code Codice	Euro €
Matte White - 9010 Bianco Opaco - 9010		14124 1000	3264,00
Coppery Bronze Bronzo Ramato	Glossy White Bianco Lucido	14124 3500	3326,00

**Light source
Sorgente luminosa**
E27 LED 3x 25 W
W/L max 12 cm / W/L max 4,72"
Bulb not included
Lampadina non inclusa



* Available while supplies last.

* Disponibile fino ad esaurimento scorte.

Random Cloud 7 Lights Ø23

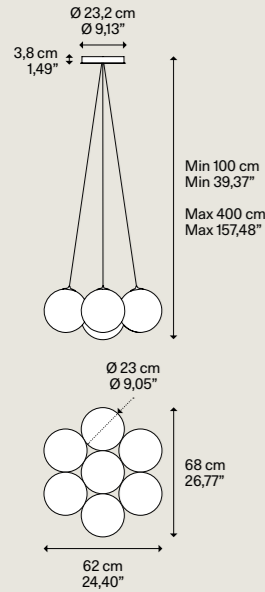

Blown glass diffuser
Diffusore in vetro soffiato

- Clear
Trasparente
- Frosted White
Bianco Satinato
- Chrome
Cromo
- Glossy Smoke
Fumo Lucido
- Glossy Bronze
Bronzo Lucido
- Gold
Oro
- Rose Gold
Oro Rosa

Metal canopy
Rosone in metallo

- Matte White - 9010
Bianco Opaco - 9010

Code Codice	A	Code Codice	B	Euro €
22121 0027		22121 0030		1839,00
22121 1327		22121 1330		2693,00
22121 4027		22121 4030		2693,00
22121 4327		22121 4330		2693,00
22121 4627		22121 4630		2693,00
22121 5027		22121 5030		2693,00
22121 5527		22121 5530		2693,00

Light source
Sorgente luminosa

LED
2700 K
7x3 W
3150 lm
350 mA
CRI 90
MacAdam 3-Step

LED and driver included
LED e driver inclusi

Light source
Sorgente luminosa

LED
3000 K
7x3 W
3360 lm
350 mA
CRI 90
MacAdam 3-Step

LED and driver included
LED e driver inclusi

Net weight 5,20 kg
Peso netto 11,46 lbs
Pack Colli 15
Energy class Classe energetica D

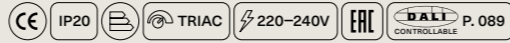

Random Cloud 7 Lights Ø28

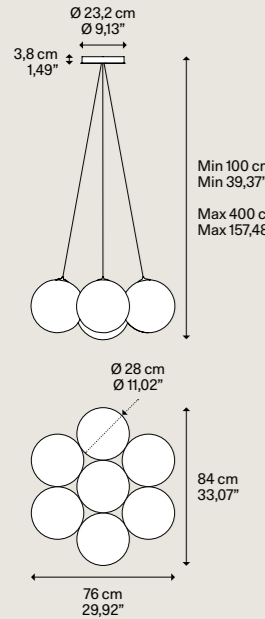

Blown glass diffuser
Diffusore in vetro soffiato

- Clear
Trasparente
- Frosted White
Bianco Satinato
- Chrome
Cromo
- Glossy Smoke
Fumo Lucido
- Glossy Bronze
Bronzo Lucido
- Gold
Oro
- Rose Gold
Oro Rosa

Metal canopy
Rosone in metallo

- Matte White - 9010
Bianco Opaco - 9010

Code Codice	A	Code Codice	B	Euro €
22122 0027		22122 0030		2126,00
22122 1327		22122 1330		2980,00
22122 4027		22122 4030		2980,00
22122 4327		22122 4330		2980,00
22122 4627		22122 4630		2980,00
22122 5027		22122 5030		2980,00
22122 5527		22122 5530		2980,00

Light source
Sorgente luminosa

LED
2700 K
7x3 W
3150 lm
350 mA
CRI 90
MacAdam 3-Step

LED and driver included
LED e driver inclusi

Light source
Sorgente luminosa

LED
3000 K
7x3 W
3360 lm
350 mA
CRI 90
MacAdam 3-Step

LED and driver included
LED e driver inclusi

Net weight 7,30 kg
Peso netto 16,09 lbs
Pack Colli 15
Energy class Classe energetica D

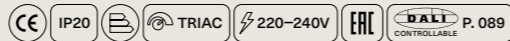

Random Cloud 14 Lights Ø23

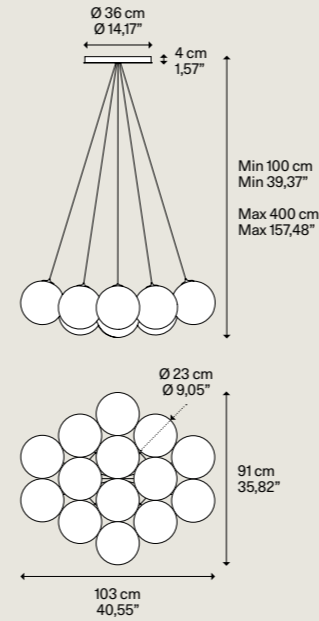

Blown glass diffuser
Diffusore in vetro soffiato

- Clear
Trasparente
- Frosted White
Bianco Satinato
- Chrome
Cromo
- Glossy Smoke
Fumo Lucido
- Glossy Bronze
Bronzo Lucido
- Gold
Oro
- Rose Gold
Oro Rosa

Metal canopy
Rosone in metallo

- Matte White - 9010
Bianco Opaco - 9010

Code Codice	A	Code Codice	B	Euro €
22123 0027		22123 0030		3576,00
22123 1327		22123 1330		5284,00
22123 4027		22123 4030		5284,00
22123 4327		22123 4330		5284,00
22123 4627		22123 4630		5284,00
22123 5027		22123 5030		5284,00
22123 5527		22123 5530		5284,00

Light source
Sorgente luminosa

LED
2700 K
14x3 W
6300 lm
350 mA
CRI 90
MacAdam 3-Step

LED and driver included
LED e driver inclusi

Light source
Sorgente luminosa

LED
3000 K
14x3 W
6720 lm
350 mA
CRI 90
MacAdam 3-Step

LED and driver included
LED e driver inclusi

Net weight 11,50 kg
Peso netto 25,35 lbs
Pack Colli 29
Energy class Classe energetica D

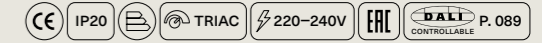

Random Cloud 14 Lights Ø28

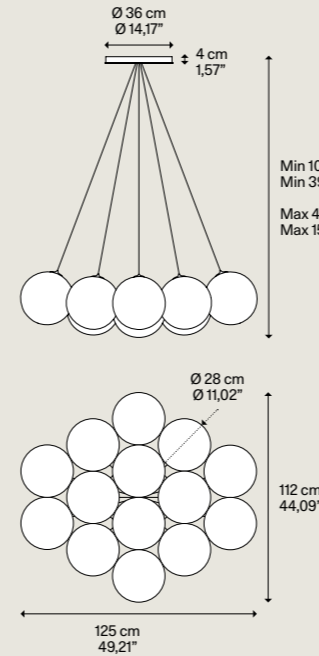

Blown glass diffuser
Diffusore in vetro soffiato

- Clear
Trasparente
- Frosted White
Bianco Satinato
- Chrome
Cromo
- Glossy Smoke
Fumo Lucido
- Glossy Bronze
Bronzo Lucido
- Gold
Oro
- Rose Gold
Oro Rosa

Metal canopy
Rosone in metallo

- Matte White - 9010
Bianco Opaco - 9010

Code Codice	A	Code Codice	B	Euro €
22124 0027		22124 0030		4150,00
22124 1327		22124 1330		5858,00
22124 4027		22124 4030		5858,00
22124 4327		22124 4330		5858,00
22124 4627		22124 4630		5858,00
22124 5027		22124 5030		5858,00
22124 5527		22124 5530		5858,00

Light source
Sorgente luminosa

LED
2700 K
14x3 W
6300 lm
350 mA
CRI 90
MacAdam 3-Step

LED and driver included
LED e driver inclusi

Light source
Sorgente luminosa

LED
3000 K
14x3 W
6720 lm
350 mA
CRI 90
MacAdam 3-Step

LED and driver included
LED e driver inclusi

Net weight 15,70 kg
Peso netto 34,61 lbs
Pack Colli 29
Energy class Classe energetica D

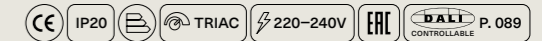

Random Cloud 19 Lights Ø23

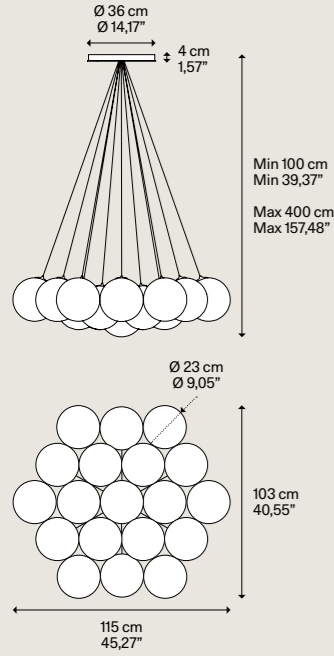

Net weight 14,50 kg / 31,96 lbs
 Pack Colli 39
 Energy class Classe energetica D

Blown glass diffuser Diffusore in vetro soffiato

- Clear Trasparente
- Frosted White Bianco Satinato
- Chrome Cromo
- Glossy Smoke Fumo Lucido
- Glossy Bronze Bronzo Lucido
- Gold Oro
- Rose Gold Oro Rosa

Metal canopy Rosone in metallo

- Matte White - 9010 Bianco Opaco - 9010

Code Codice	Code Codice	Euro €
22125 0027	22125 0030	4751,00
22125 1327	22125 1330	7069,00
22125 4027	22125 4030	7069,00
22125 4327	22125 4330	7069,00
22125 4627	22125 4630	7069,00
22125 5027	22125 5030	7069,00
22125 5527	22125 5530	7069,00

Light source Sorgente luminosa

LED
 2700 K
 19x3 W
 8550 lm
 350 mA
 CRI 90
 MacAdam 3-Step

LED and driver included
 LED e driver inclusi

Light source Sorgente luminosa

LED
 3000 K
 19x3 W
 9120 lm
 350 mA
 CRI 90
 MacAdam 3-Step

LED and driver included
 LED e driver inclusi

CE IP20 TRIAC 220-240V ENEC DALI CONTROLLABLE P. 089

Random Cloud 19 Lights Ø28

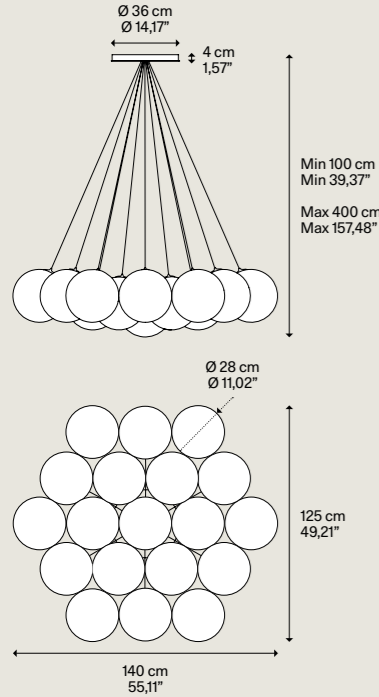

Net weight 20,20 kg / 44,53 lbs
 Pack Colli 39
 Energy class Classe energetica D

Blown glass diffuser Diffusore in vetro soffiato

- Clear Trasparente
- Frosted White Bianco Satinato
- Chrome Cromo
- Glossy Smoke Fumo Lucido
- Glossy Bronze Bronzo Lucido
- Gold Oro
- Rose Gold Oro Rosa

Metal canopy Rosone in metallo

- Matte White - 9010 Bianco Opaco - 9010

Code Codice	Code Codice	Euro €
22126 0027	22126 0030	5530,00
22126 1327	22126 1330	7848,00
22126 4027	22126 4030	7848,00
22126 4327	22126 4330	7848,00
22126 4627	22126 4630	7848,00
22126 5027	22126 5030	7848,00
22126 5527	22126 5530	7848,00

Light source Sorgente luminosa

LED
 2700 K
 19x3 W
 8550 lm
 350 mA
 CRI 90
 MacAdam 3-Step

LED and driver included
 LED e driver inclusi

Light source Sorgente luminosa

LED
 3000 K
 19x3 W
 9120 lm
 350 mA
 CRI 90
 MacAdam 3-Step

LED and driver included
 LED e driver inclusi

CE IP20 TRIAC 220-240V ENEC DALI CONTROLLABLE P. 089

Random Cloud 23 Lights Ø23

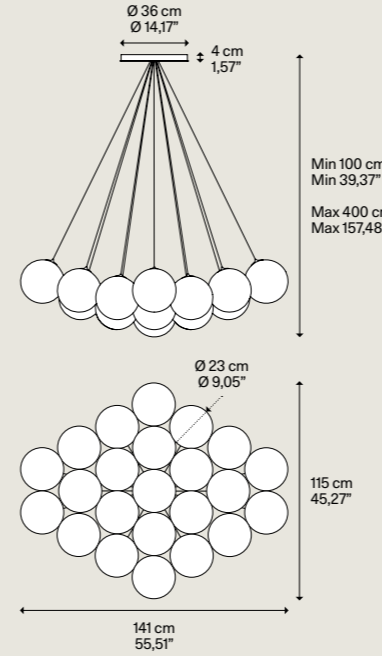

Net weight 16,90 kg / 37,25 lbs
 Pack Colli 47
 Energy class Classe energetica D

Blown glass diffuser Diffusore in vetro soffiato

- Clear Trasparente
- Frosted White Bianco Satinato
- Chrome Cromo
- Glossy Smoke Fumo Lucido
- Glossy Bronze Bronzo Lucido
- Gold Oro
- Rose Gold Oro Rosa

Metal canopy Rosone in metallo

- Matte White - 9010 Bianco Opaco - 9010

Code Codice	Code Codice	Euro €
22127 0027	22127 0030	5691,00
22127 1327	22127 1330	8497,00
22127 4027	22127 4030	8497,00
22127 4327	22127 4330	8497,00
22127 4627	22127 4630	8497,00
22127 5027	22127 5030	8497,00
22127 5527	22127 5530	8497,00

Light source Sorgente luminosa

LED
 2700 K
 23x3 W
 10350 lm
 350 mA
 CRI 90
 MacAdam 3-Step

LED and driver included
 LED e driver inclusi

Light source Sorgente luminosa

LED
 3000 K
 23x3 W
 11040 lm
 350 mA
 CRI 90
 MacAdam 3-Step

LED and driver included
 LED e driver inclusi

CE IP20 TRIAC 220-240V ENEC DALI CONTROLLABLE P. 089

Random Cloud 23 Lights Ø28

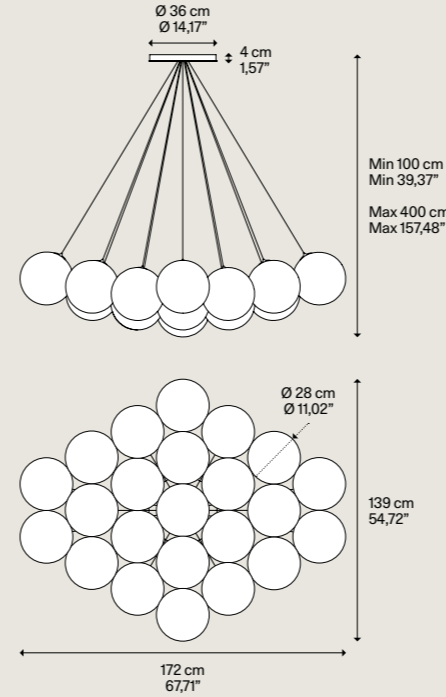

Net weight 23,80 kg / 52,47 lbs
 Pack Colli 47
 Energy class Classe energetica D

Blown glass diffuser Diffusore in vetro soffiato

- Clear Trasparente
- Frosted White Bianco Satinato
- Chrome Cromo
- Glossy Smoke Fumo Lucido
- Glossy Bronze Bronzo Lucido
- Gold Oro
- Rose Gold Oro Rosa

Metal canopy Rosone in metallo

- Matte White - 9010 Bianco Opaco - 9010

Code Codice	Code Codice	Euro €
22128 0027	22128 0030	6634,00
22128 1327	22128 1330	9440,00
22128 4027	22128 4030	9440,00
22128 4327	22128 4330	9440,00
22128 4627	22128 4630	9440,00
22128 5027	22128 5030	9440,00
22128 5527	22128 5530	9440,00

Light source Sorgente luminosa

LED
 2700 K
 23x3 W
 10350 lm
 350 mA
 CRI 90
 MacAdam 3-Step

LED and driver included
 LED e driver inclusi

Light source Sorgente luminosa

LED
 3000 K
 23x3 W
 11040 lm
 350 mA
 CRI 90
 MacAdam 3-Step

LED and driver included
 LED e driver inclusi

CE IP20 TRIAC 220-240V ENEC DALI CONTROLLABLE P. 089

Random Stick short

Description Descrizione	Dimensions Dimensioni	
Metal structure Montatura in metallo	100 cm 39,37"	①
Blown glass sphere Sfera in vetro soffiato	Ø 10 cm Ø 3,93"	②
Blown glass sphere Sfera in vetro soffiato	Ø 12 cm Ø 4,72"	③
Blown glass sphere Sfera in vetro soffiato	Ø 14 cm Ø 5,51"	④
Blown glass sphere Sfera in vetro soffiato	Ø 10 cm Ø 3,93"	⑤

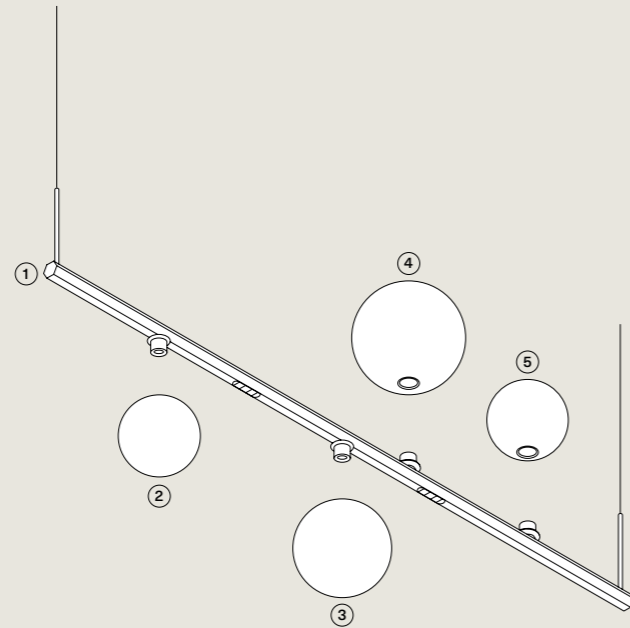

Net weight Peso netto	1,83 kg 4,03 lbs	Pack Colli	5	Energy class Classe energetica	D
--------------------------	---------------------	---------------	---	-----------------------------------	---

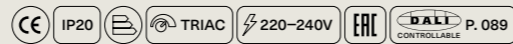

For the product coding, see table ► P. 018
Per la codifica del prodotto, consultare la tabella ► P. 018

Random Stick short

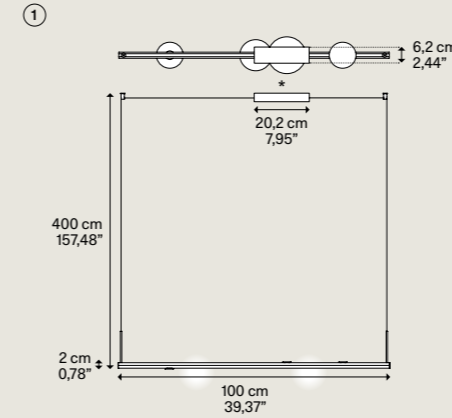

* Adjustable canopy position
* Posizione del rosone regolabile

Metal structure Montatura in metallo		Code Codice	A Code Codice	B Code Codice	Euro €	VAT excluded IVA esclusa
I Extra Matte White	Bianco Extra Opaco	23420M 1027	23420M 1030		590,00	
II Black Chrome	Cromo Nero	23420M 2227	23420M 2230		740,00	
III Glossy Gold	Oro Lucido	23420M 5027	23420M 5030		890,00	



Light source Sorgente luminosa	A	B
LED	2700	3000
	K	K
	3x 2 W + 4x 1 W	3x 2 W + 4x 1 W
	1500	1600
	lm	lm
Diffused light	600 lm	640 lm
Direct light	900 lm	960 lm
	350 mA	350 mA
	CRI 90	CRI 90
	MacAdam 3-Step	MacAdam 3-Step
	LED and driver included	LED and driver included
	LED e driver inclusi	LED e driver inclusi

Light source Sorgente luminosa	A	B
LED	2700	3000
	K	K
	3x 2 W + 4x 1 W	3x 2 W + 4x 1 W
	1500	1600
	lm	lm
Diffused light	600 lm	640 lm
Direct light	900 lm	960 lm
	350 mA	350 mA
	CRI 90	CRI 90
	MacAdam 3-Step	MacAdam 3-Step
	LED and driver included	LED and driver included
	LED e driver inclusi	LED e driver inclusi

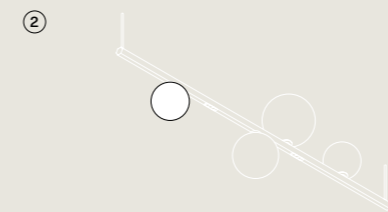

Description Descrizione	Blown glass diffuser Diffusore in vetro soffiato	Code Codice	Euro €	VAT excluded IVA esclusa
Blown glass sphere Ø 10 cm/3,93"	IV Clear Trasparente	17110V 00	16,00	
Sfera in vetro soffiato Ø 10 cm/3,93"	V Frosted White Bianco Satinato	17110V 13	39,00	
	VI Chrome Cromo	17110V 40	39,00	
	VII Glossy Smoke Fumo Lucido	17110V 43	39,00	
	VIII Glossy Bronze Bronzo Lucido	17110V 46	39,00	
	IX Gold Oro	17110V 50	39,00	
	X Rose Gold Oro Rosa	17110V 55	39,00	

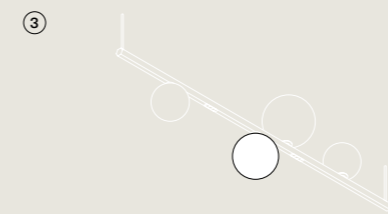

Description Descrizione	Blown glass diffuser Diffusore in vetro soffiato	Code Codice	Euro €	VAT excluded IVA esclusa
Blown glass sphere Ø 12 cm/4,72"	IV Clear Trasparente	17111V 00	39,00	
Sfera in vetro soffiato Ø 12 cm/4,72"	V Frosted White Bianco Satinato	17111V 13	64,00	
	VI Chrome Cromo	17111V 40	64,00	
	VII Glossy Smoke Fumo Lucido	17111V 43	64,00	
	VIII Glossy Bronze Bronzo Lucido	17111V 46	64,00	
	IX Gold Oro	17111V 50	64,00	
	X Rose Gold Oro Rosa	17111V 55	64,00	

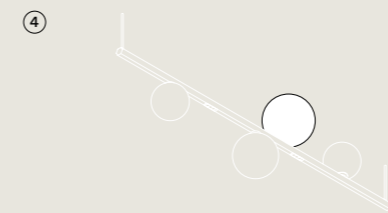

Description Descrizione	Blown glass diffuser Diffusore in vetro soffiato	Code Codice	Euro €	VAT excluded IVA esclusa
Blown glass sphere Ø 14 cm/5,51"	IV Clear Trasparente	17112V 00	44,00	
Sfera in vetro soffiato Ø 14 cm/5,51"	V Frosted White Bianco Satinato	17112V 13	75,00	
	VI Chrome Cromo	17112V 40	75,00	
	VII Glossy Smoke Fumo Lucido	17112V 43	75,00	
	VIII Glossy Bronze Bronzo Lucido	17112V 46	75,00	
	IX Gold Oro	17112V 50	75,00	
	X Rose Gold Oro Rosa	17112V 55	75,00	

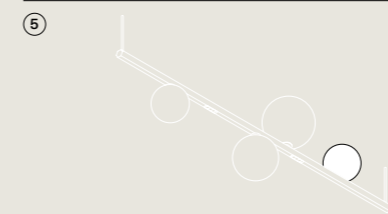

Description Descrizione	Blown glass diffuser Diffusore in vetro soffiato	Code Codice	Euro €	VAT excluded IVA esclusa
Blown glass sphere Ø 10 cm/3,93"	IV Clear Trasparente	17110V 00	16,00	
Sfera in vetro soffiato Ø 10 cm/3,93"	V Frosted White Bianco Satinato	17110V 13	39,00	
	VI Chrome Cromo	17110V 40	39,00	
	VII Glossy Smoke Fumo Lucido	17110V 43	39,00	
	VIII Glossy Bronze Bronzo Lucido	17110V 46	39,00	
	IX Gold Oro	17110V 50	39,00	
	X Rose Gold Oro Rosa	17110V 55	39,00	



Random Stick long

Description Descrizione	Dimensions Dimensioni	
Metal structure Montatura in metallo	150 cm 59,05"	①
Blown glass sphere Sfera in vetro soffiato	Ø 14 cm Ø 5,51"	②
Blown glass sphere Sfera in vetro soffiato	Ø 10 cm Ø 3,93"	③
Blown glass sphere Sfera in vetro soffiato	Ø 12 cm Ø 4,72"	④
Blown glass sphere Sfera in vetro soffiato	Ø 18 cm Ø 7,08"	⑤
Blown glass sphere Sfera in vetro soffiato	Ø 10 cm Ø 3,93"	⑥
Blown glass sphere Sfera in vetro soffiato	Ø 18 cm Ø 7,08"	⑦

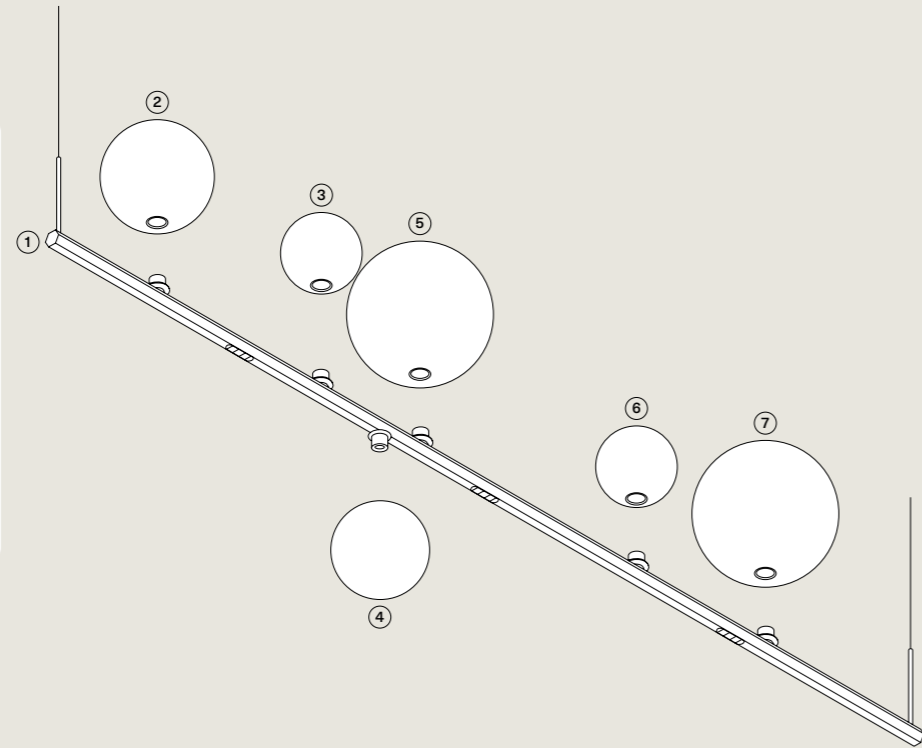

Net weight Peso netto	2,84 kg 6,26 lbs	Pack Colli	7	Energy class Classe energetica	D
--------------------------	---------------------	---------------	---	-----------------------------------	---

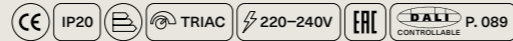

For the product coding, see table ► P. 019
Per la codifica del prodotto, consultare la tabella ► P. 019

Random Stick long

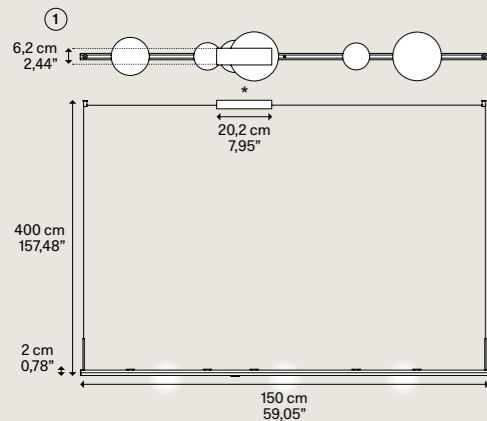

Metal structure Montatura in metallo		Code Codice	A	Code Codice	B	Euro €	VAT excluded IVA esclusa
I Extra Matte White	Bianco Extra Opaco	23421M 1027		23421M 1030		750,00	
II Black Chrome	Cromo Nero	23421M 2227		23421M 2230		950,00	
III Glossy Gold	Oro Lucido	23421M 5027		23421M 5030		1150,00	



Light source Sorgente luminosa	A	B
LED 2700 K 3x 3 W + 6x 1 W 2250 lm Diffused light ↘ 900 lm Direct light ↘ 1350 lm 350 mA CRI 90 MacAdam 3-Step		

Light source Sorgente luminosa	A	B
LED 3000 K 3x 3 W + 6x 1 W 2400 lm Diffused light ↘ 980 lm Direct light ↘ 1720 lm 350 mA CRI 90 MacAdam 3-Step		

LED and driver included
LED e driver inclusi

LED and driver included
LED e driver inclusi

* Adjustable canopy position
* Posizione del rosone regolabile

Random Stick long

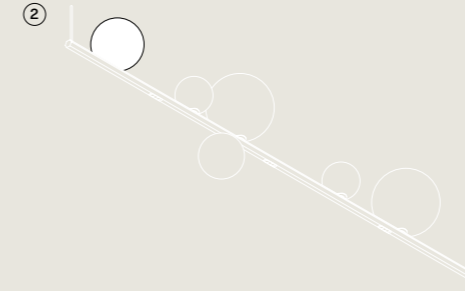

Description Descrizione	Blown glass diffuser Diffusore in vetro soffiato	Code Codice	Euro €	VAT excluded IVA esclusa
Blown glass sphere Ø 14 cm/5,51" Sfera in vetro soffiato Ø 14 cm/5,51"	IV Clear Trasparente	17112V 00	44,00	
	V Frosted White Bianco Satinato	17112V 13	75,00	
	VI Chrome Cromo	17112V 40	75,00	
	VII Glossy Smoke Fumo Lucido	17112V 43	75,00	
	VIII Glossy Bronze Bronzo Lucido	17112V 46	75,00	
	IX Gold Oro	17112V 50	75,00	
	X Rose Gold Oro Rosa	17112V 55	75,00	

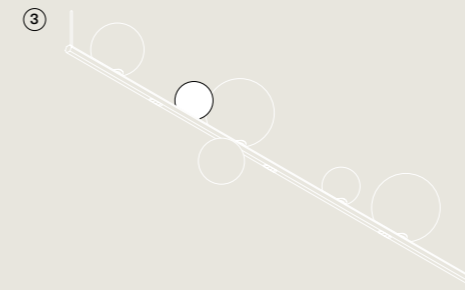

Description Descrizione	Blown glass diffuser Diffusore in vetro soffiato	Code Codice	Euro €	VAT excluded IVA esclusa
Blown glass sphere Ø 10 cm/3,93" Sfera in vetro soffiato Ø 10 cm/3,93"	IV Clear Trasparente	17110V 00	16,00	
	V Frosted White Bianco Satinato	17110V 13	39,00	
	VI Chrome Cromo	17110V 40	39,00	
	VII Glossy Smoke Fumo Lucido	17110V 43	39,00	
	VIII Glossy Bronze Bronzo Lucido	17110V 46	39,00	
	IX Gold Oro	17110V 50	39,00	
	X Rose Gold Oro Rosa	17110V 55	39,00	

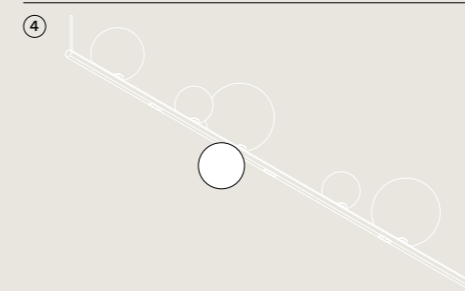
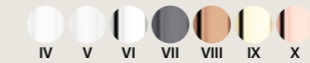

Description Descrizione	Blown glass diffuser Diffusore in vetro soffiato	Code Codice	Euro €	VAT excluded IVA esclusa
Blown glass sphere Ø 12 cm/4,72" Sfera in vetro soffiato Ø 12 cm/4,72"	IV Clear Trasparente	17111V 00	39,00	
	V Frosted White Bianco Satinato	17111V 13	64,00	
	VI Chrome Cromo	17111V 40	64,00	
	VII Glossy Smoke Fumo Lucido	17111V 43	64,00	
	VIII Glossy Bronze Bronzo Lucido	17111V 46	64,00	
	IX Gold Oro	17111V 50	64,00	
	X Rose Gold Oro Rosa	17111V 55	64,00	

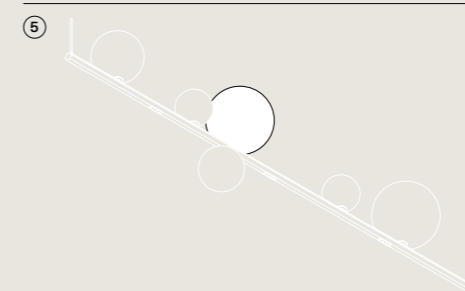

Description Descrizione	Blown glass diffuser Diffusore in vetro soffiato	Code Codice	Euro €	VAT excluded IVA esclusa
Blown glass sphere Ø 18 cm/7,08" Sfera in vetro soffiato Ø 18 cm/7,08"	IV Clear Trasparente	17113V 00	59,00	
	V Frosted White Bianco Satinato	17113V 13	90,00	
	VI Chrome Cromo	17113V 40	90,00	
	VII Glossy Smoke Fumo Lucido	17113V 43	90,00	
	VIII Glossy Bronze Bronzo Lucido	17113V 46	90,00	
	IX Gold Oro	17113V 50	90,00	
	X Rose Gold Oro Rosa	17113V 55	90,00	

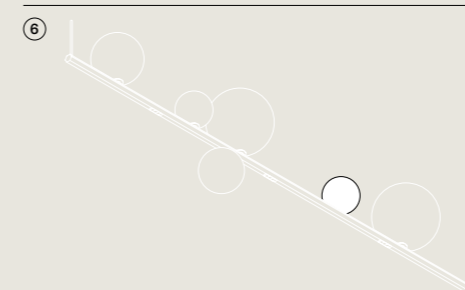

Description Descrizione	Blown glass diffuser Diffusore in vetro soffiato	Code Codice	Euro €	VAT excluded IVA esclusa
Blown glass sphere Ø 10 cm/3,93" Sfera in vetro soffiato Ø 10 cm/3,93"	IV Clear Trasparente	17110V 00	16,00	
	V Frosted White Bianco Satinato	17110V 13	39,00	
	VI Chrome Cromo	17110V 40	39,00	
	VII Glossy Smoke Fumo Lucido	17110V 43	39,00	
	VIII Glossy Bronze Bronzo Lucido	17110V 46	39,00	
	IX Gold Oro	17110V 50	39,00	
	X Rose Gold Oro Rosa	17110V 55	39,00	

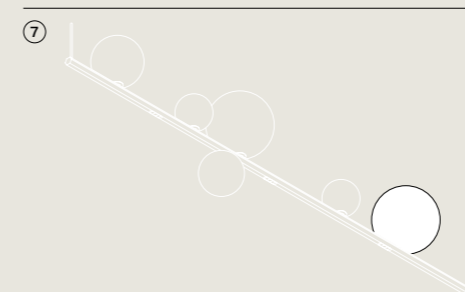

Description Descrizione	Blown glass diffuser Diffusore in vetro soffiato	Code Codice	Euro €	VAT excluded IVA esclusa
Blown glass sphere Ø 18 cm/7,08" Sfera in vetro soffiato Ø 18 cm/7,08"	IV Clear Trasparente	17113V 00	59,00	
	V Frosted White Bianco Satinato	17113V 13	90,00	
	VI Chrome Cromo	17113V 40	90,00	
	VII Glossy Smoke Fumo Lucido	17113V 43	90,00	
	VIII Glossy Bronze Bronzo Lucido	17113V 46	90,00	
	IX Gold Oro	17113V 50	90,00	
	X Rose Gold Oro Rosa	17113V 55	90,00	



Random Stick short

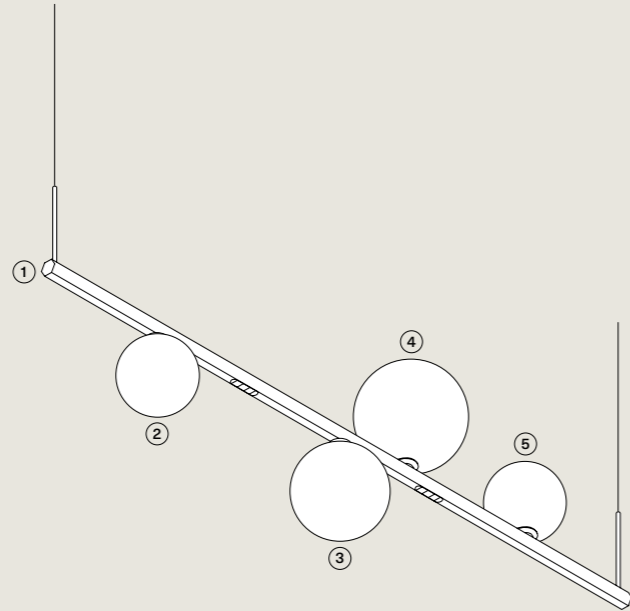

Create the product code
Crea il codice prodotto

Structure 100		Sphere 10	Sphere 12	Sphere 14	Sphere 10				
2700 K	3000 K								
I	23420M 1027	23420M 1030	17110V 00	17111V 00	17112V 00	17110V 00			
			17110V 13	17111V 13	17112V 13	17110V 13			
II	23420M 2227	23420M 2230	17110V 40	17111V 40	17112V 40	17110V 40			
			17110V 43	17111V 43	17112V 43	17110V 43			
			17110V 46	17111V 46	17112V 46	17110V 46			
			17110V 50	17111V 50	17112V 50	17110V 50			
III	23420M 5027	23420M 5030	17110V 55	17111V 55	17112V 55	17110V 55			
①		②	③	④	⑤				
23420M ____		+	17110V __	+	17111V __	+	17112V __	+	17110V __

I	Extra Matte White	Bianco Extra Opaco	VI	Chrome	Cromo
II	Black Chrome	Cromo Nero	VII	Glossy Smoke	Fumo Lucido
III	Glossy Gold	Oro Lucido	VIII	Glossy Bronze	Bronzo Lucido
IV	Clear	Trasparente	IX	Gold	Oro
V	Frosted White	Bianco Satinato	X	Rose Gold	Oro Rosa

Random Stick long

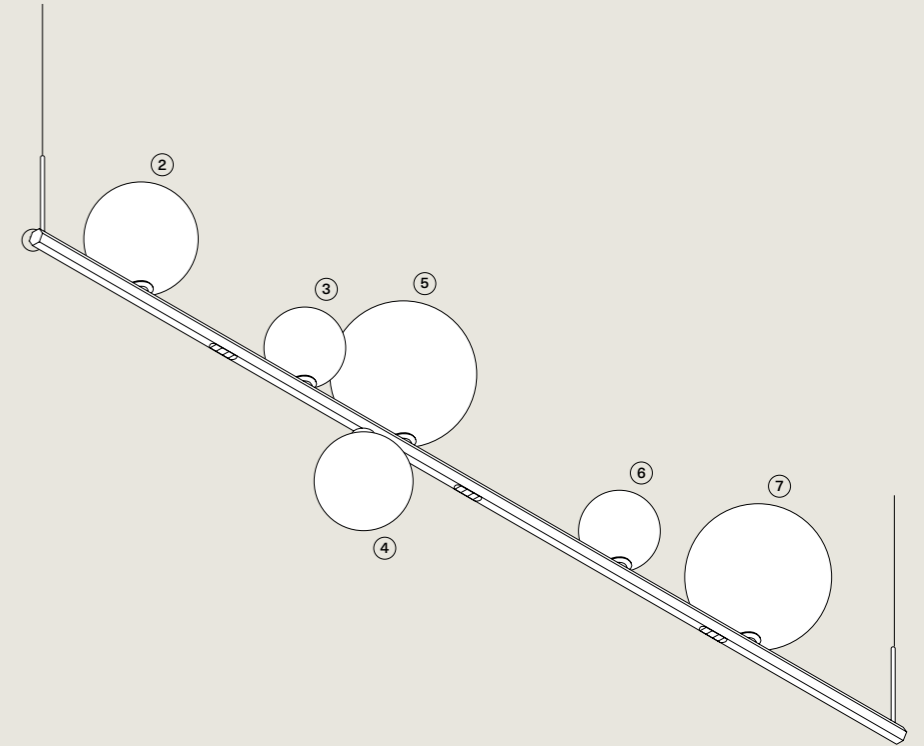

Create the product code
Crea il codice prodotto

Structure 150		Sphere 14	Sphere 10	Sphere 12	Sphere 18	Sphere 10	Sphere 18						
2700 K	3000 K												
I	23421M 1027	23421M 1030	17112V 00	17110V 00	17111V 00	17113V 00	17110V 00	17113V 00					
			17112V 13	17110V 13	17111V 13	17113V 13	17110V 13	17113V 13					
II	23421M 2227	23421M 2230	17112V 40	17110V 40	17111V 40	17113V 40	17110V 40	17113V 40					
			17112V 43	17110V 43	17111V 43	17113V 43	17110V 43	17113V 43					
			17112V 46	17110V 46	17111V 46	17113V 46	17110V 46	17113V 46					
			17112V 50	17110V 50	17111V 50	17113V 50	17110V 50	17113V 50					
III	23421M 5027	23421M 5030	17112V 55	17110V 55	17111V 55	17113V 55	17110V 55	17113V 55					
①		②	③	④	⑤	⑥	⑦						
23421M ____		+	17112V __	+	17110V __	+	17111V __	+	17113V __	+	17110V __	+	17113V __

I	Extra Matte White	Bianco Extra Opaco	VI	Chrome	Cromo
II	Black Chrome	Cromo Nero	VII	Glossy Smoke	Fumo Lucido
III	Glossy Gold	Oro Lucido	VIII	Glossy Bronze	Bronzo Lucido
IV	Clear	Trasparente	IX	Gold	Oro
V	Frosted White	Bianco Satinato	X	Rose Gold	Oro Rosa

Sky-Fall medium

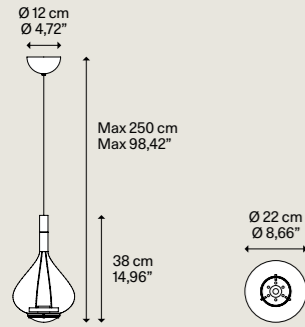

Metal structure Montatura in metallo	Blown glass diffuser Diffusore in vetro soffiato	Code Codice	Code Codice	Euro €
Chrome Cromo	Clear Trasparente	14822 0027	14822 0030	582,00
	Glossy Smoke Fumo Lucido	14822 4327	14822 4330	709,00
	Glossy Bronze Bronzo Lucido	14822 4627	14822 4630	709,00
	Golden Sage Salvia Dorata	14822 7127	14822 7130	709,00

**Light source
Sorgente luminosa**

LED

2700	K
2x 8,5	W
1815	lm
350	mA

CRI 95
MacAdam 3-Step

LED and driver included
LED e driver inclusi

**Light source
Sorgente luminosa**

LED

3000	K
2x 8,5	W
1870	lm
350	mA

CRI 95
MacAdam 3-Step

LED and driver included
LED e driver inclusi

Net weight Peso netto	1,65 kg 3,64 lbs	Pack Colli	2	Energy class Classe energetica	E
--------------------------	---------------------	---------------	---	-----------------------------------	---

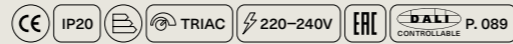

Sky-Fall large

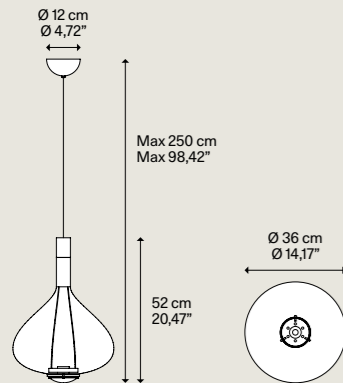

Metal structure Montatura in metallo	Blown glass diffuser Diffusore in vetro soffiato	Code Codice	Code Codice	Euro €
Chrome Cromo	Clear Trasparente	14821 0027	14821 0030	800,00
	Glossy Smoke Fumo Lucido	14821 4327	14821 4330	1082,00
	Glossy Bronze Bronzo Lucido	14821 4627	14821 4630	1082,00
	Golden Sage Salvia Dorata	14821 7127	14821 7130	1082,00

**Light source
Sorgente luminosa**

LED

2700	K
2x 8,5	W
1815	lm
350	mA

CRI 95
MacAdam 3-Step

LED and driver included
LED e driver inclusi

**Light source
Sorgente luminosa**

LED

3000	K
2x 8,5	W
1870	lm
350	mA

CRI 95
MacAdam 3-Step

LED and driver included
LED e driver inclusi

Net weight Peso netto	3,05 kg 6,72 lbs	Pack Colli	2	Energy class Classe energetica	E
--------------------------	---------------------	---------------	---	-----------------------------------	---

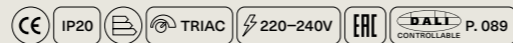

Sky-Fall Round medium

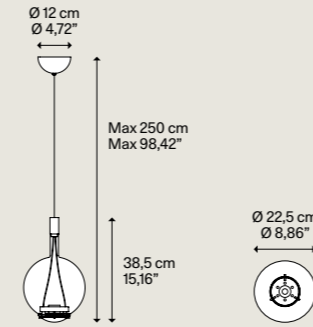

Metal structure Montatura in metallo	Blown glass diffuser Diffusore in vetro soffiato	Code Codice	Code Codice	Euro €
Chrome Cromo	Clear Trasparente	14824 0027	14824 0030	607,00
	Glossy Smoke Fumo Lucido	14824 4327	14824 4330	745,00
	Glossy Bronze Bronzo Lucido	14824 4627	14824 4630	745,00
	Golden Sage Salvia Dorata	14824 7127	14824 7130	745,00

**Light source
Sorgente luminosa**

LED

2700	K
2x 8,5	W
1815	lm
350	mA

CRI 95
MacAdam 3-Step

LED and driver included
LED e driver inclusi

**Light source
Sorgente luminosa**

LED

3000	K
2x 8,5	W
1870	lm
350	mA

CRI 95
MacAdam 3-Step

LED and driver included
LED e driver inclusi

Net weight Peso netto	1,47 kg 3,24 lbs	Pack Colli	2	Energy class Classe energetica	E
--------------------------	---------------------	---------------	---	-----------------------------------	---



Sky-Fall Round large

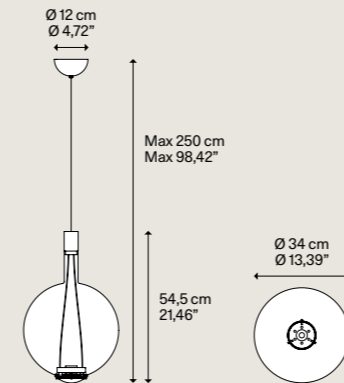

Metal structure Montatura in metallo	Blown glass diffuser Diffusore in vetro soffiato	Code Codice	Code Codice	Euro €
Chrome Cromo	Clear Trasparente	14823 0027	14823 0030	842,00
	Glossy Smoke Fumo Lucido	14823 4327	14823 4330	1133,00
	Glossy Bronze Bronzo Lucido	14823 4627	14823 4630	1133,00
	Golden Sage Salvia Dorata	14823 7127	14823 7130	1133,00

**Light source
Sorgente luminosa**

LED

2700	K
2x 8,5	W
1815	lm
350	mA

CRI 95
MacAdam 3-Step

LED and driver included
LED e driver inclusi

**Light source
Sorgente luminosa**

LED

3000	K
2x 8,5	W
1870	lm
350	mA

CRI 95
MacAdam 3-Step

LED and driver included
LED e driver inclusi

Net weight Peso netto	2,64 kg 5,82 lbs	Pack Colli	2	Energy class Classe energetica	E
--------------------------	---------------------	---------------	---	-----------------------------------	---

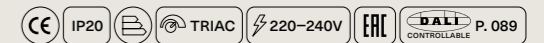

Tidal

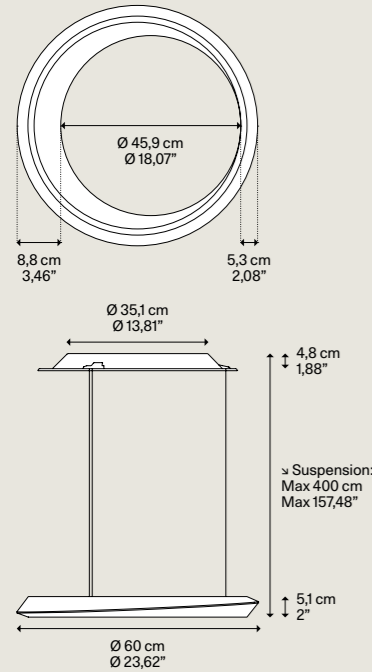

Light source A Sorgente luminosa		Light source B Sorgente luminosa	
LED	K	LED	K
2700	3000	3000	3000
33	33	33	33
6120	6630	6630	6630
350+350	350+350	350+350	350+350
mA	mA	mA	mA
CRI 90	CRI 90	CRI 90	CRI 90
MacAdam 3-Step	MacAdam 3-Step	MacAdam 3-Step	MacAdam 3-Step
LED and driver included LED e driver inclusi		LED and driver included LED e driver inclusi	
Double switch Doppia accensione		Double switch Doppia accensione	

Pack Colli 2 Energy class Classe energetica C



SUSPENSION TRIAC				VAT excluded IVA esclusa
Metal structure Montatura in metallo	Round canopy Rosone rotondo	Code Codice	Code Codice	Euro €
Matte White - 9016 Bianco Opaco - 9016		19921 1027	19921 1030	1260,00
Matte Black - 9005 Nero Opaco - 9005		19921 2027	19921 2030	1260,00
Extra Matte Champagne Champagne Extra Opaco	Matte White - 9016 Bianco Opaco - 9016	19921 4527	19921 4530	1290,00
Terra Terra		19921 6727	19921 6730	1320,00
Matte White - 9016 Bianco Opaco - 9016		19922 1027	19922 1030	1260,00
Matte Black - 9005 Nero Opaco - 9005		19922 2027	19922 2030	1260,00
Extra Matte Champagne Champagne Extra Opaco	Matte Black - 9005 Nero Opaco - 9005	19922 4527	19922 4530	1290,00
Terra Terra		19922 6727	19922 6730	1320,00

SUSPENSION DALI				VAT excluded IVA esclusa
Metal structure Montatura in metallo	Round canopy Rosone rotondo	Code Codice	Code Codice	Euro €
Matte White - 9016 Bianco Opaco - 9016		19925 1027	19925 1030	1360,00
Matte Black - 9005 Nero Opaco - 9005		19925 2027	19925 2030	1360,00
Extra Matte Champagne Champagne Extra Opaco	Matte White - 9016 Bianco Opaco - 9016	19925 4527	19925 4530	1390,00
Terra Terra		19925 6727	19925 6730	1420,00
Matte White - 9016 Bianco Opaco - 9016		19926 1027	19926 1030	1360,00
Matte Black - 9005 Nero Opaco - 9005		19926 2027	19926 2030	1360,00
Extra Matte Champagne Champagne Extra Opaco	Matte Black - 9005 Nero Opaco - 9005	19926 4527	19926 4530	1390,00
Terra Terra		19926 6727	19926 6730	1420,00

SUSPENSION **ADJUSTABLE SUSPENSION**

Light emission Emissione luminosa

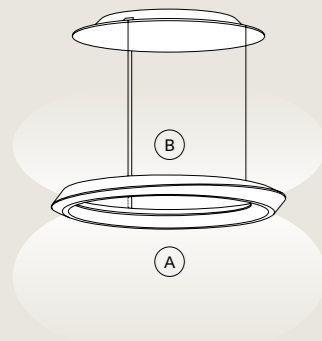

		Tidal	
A Direct light emission Emissione di luce diretta	2700 K	3060 lm	
	3000 K	3315 lm	
B Indirect light emission Emissione di luce indiretta	2700 K	3060 lm	
	3000 K	3315 lm	

Tidal

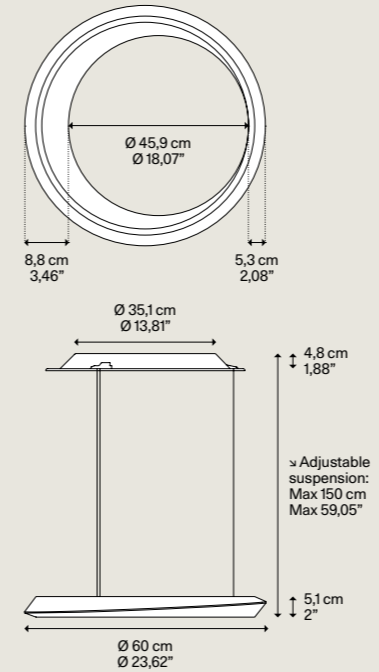

Light source A Sorgente luminosa		Light source B Sorgente luminosa	
LED	K	LED	K
2700	3000	3000	3000
33	33	33	33
6120	6630	6630	6630
350+350	350+350	350+350	350+350
mA	mA	mA	mA
CRI 90	CRI 90	CRI 90	CRI 90
MacAdam 3-Step	MacAdam 3-Step	MacAdam 3-Step	MacAdam 3-Step
LED and driver included LED e driver inclusi		LED and driver included LED e driver inclusi	
Double switch Doppia accensione		Double switch Doppia accensione	

Pack Colli 2 Energy class Classe energetica C



ADJUSTABLE SUSPENSION TRIAC				VAT excluded IVA esclusa
Metal structure Montatura in metallo	Round canopy Rosone rotondo	Code Codice	Code Codice	Euro €
Matte White - 9016 Bianco Opaco - 9016		19923 1027	19923 1030	1460,00
Matte Black - 9005 Nero Opaco - 9005		19923 2027	19923 2030	1460,00
Extra Matte Champagne Champagne Extra Opaco	Matte White - 9016 Bianco Opaco - 9016	19923 4527	19923 4530	1490,00
Terra Terra		19923 6727	19923 6730	1520,00
Matte White - 9016 Bianco Opaco - 9016		19924 1027	19924 1030	1460,00
Matte Black - 9005 Nero Opaco - 9005		19924 2027	19924 2030	1460,00
Extra Matte Champagne Champagne Extra Opaco	Matte Black - 9005 Nero Opaco - 9005	19924 4527	19924 4530	1490,00
Terra Terra		19924 6727	19924 6730	1520,00

ADJUSTABLE SUSPENSION DALI				VAT excluded IVA esclusa
Metal structure Montatura in metallo	Round canopy Rosone rotondo	Code Codice	Code Codice	Euro €
Matte White - 9016 Bianco Opaco - 9016		19927 1027	19927 1030	1560,00
Matte Black - 9005 Nero Opaco - 9005		19927 2027	19927 2030	1560,00
Extra Matte Champagne Champagne Extra Opaco	Matte White - 9016 Bianco Opaco - 9016	19927 4527	19927 4530	1590,00
Terra Terra		19927 6727	19927 6730	1620,00
Matte White - 9016 Bianco Opaco - 9016		19928 1027	19928 1030	1560,00
Matte Black - 9005 Nero Opaco - 9005		19928 2027	19928 2030	1560,00
Extra Matte Champagne Champagne Extra Opaco	Matte Black - 9005 Nero Opaco - 9005	19928 4527	19928 4530	1590,00
Terra Terra		19928 6727	19928 6730	1620,00

ADJUSTABLE SUSPENSION

Adjustable suspension Sospensione saliscendi

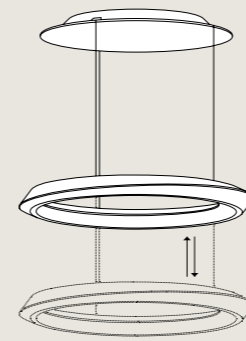

Volum 42

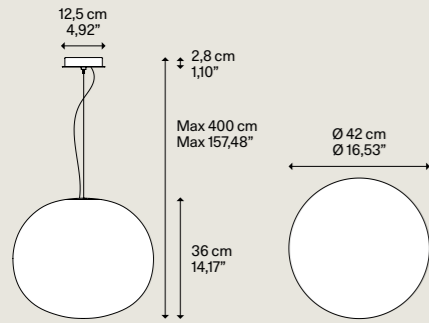

Net weight	3,64 kg	Pack	2
Peso netto	8,02 lbs	Colli	

Methacrylate structure
Struttura in metacrilato

Glossy White
Bianco Lucido

Blown glass diffuser
Diffusore in vetro soffiato

Glossy White
Bianco Lucido

Code
Codice

18720 1200

Euro €

520,00

Light source
Sorgente luminosa

E27 LED T35 Ø max 9,8 cm
1 x 21 W Ø max 3,74"
(max 25 W)

Bulb not included
Lampadina non inclusa

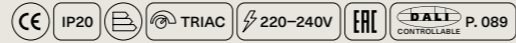

Light source Sorgente luminosa			Bulb dimension Dimensione lampadina		Lamp Lampada	Pack Colli	Code Codice	Euro €
E27 LED T35	2700 K	CRI 90	Ø 3,5 cm	W/L 15 cm	Volum 42	1	LAM-0016	46,00
21 W	2010 lm	MacAdam 3-Step	Ø 1,37"	W/L 5,90"				

Dimmable bulbs/Lampadine dimmerabili

Cluster suspension lamps

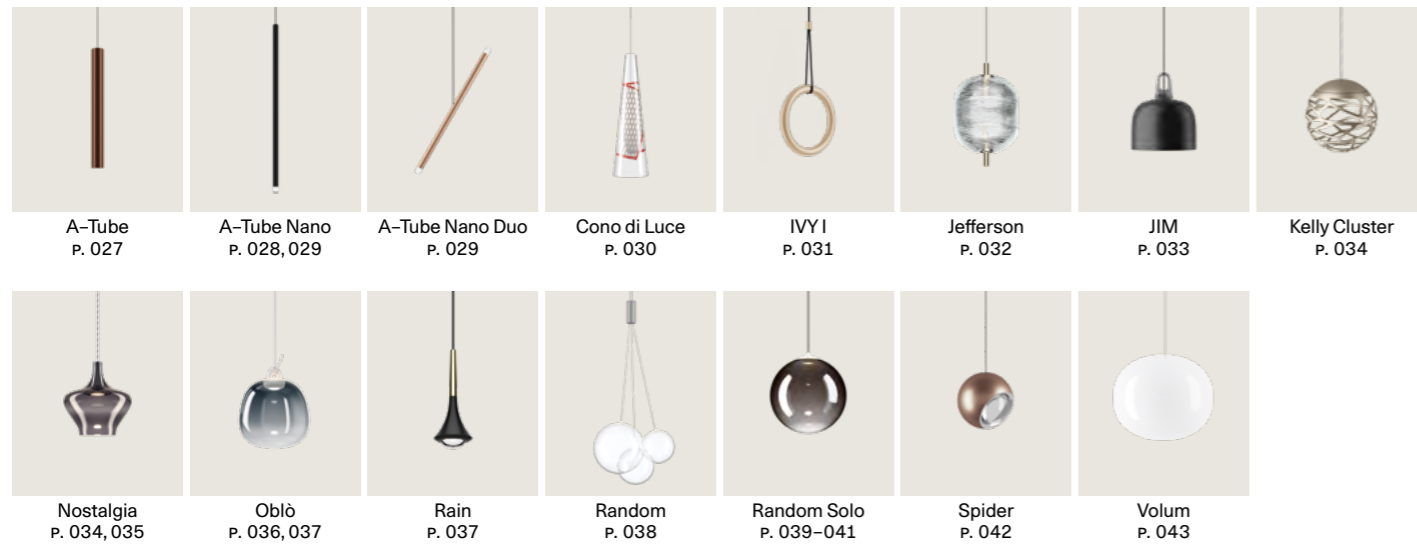

CATEGORY CLUSTER SUSPENSION LAMP

DESIGN Studio Italia Design, 2013

VAT excluded
IVA esclusa

A-Tube small

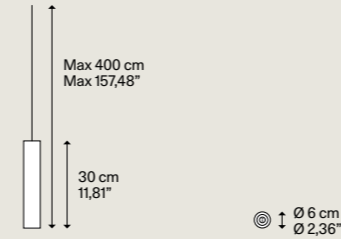

Net weight 1,12 kg
Peso netto 2,47 lbs
Pack Colli 1

Light source
Sorgente luminosa

GU10 Par 16 LED 1x 10 W
W/L max 8,5 cm
W/L max 3,34"

Bulb not included
Lampadina non inclusa

Metal structure
Montatura in metallo

Matte White - 9010
Bianco Opaco - 9010

Matte Black - 9005
Nero Opaco - 9005

Coppery Bronze
Bronzo Ramato

Code
Codice

09622 1000

09622 2000

09622 3500

Euro €

174,00

174,00

179,00

CE IP20 TRIAC 220-240V ENEC DALI P. 089

A-Tube medium

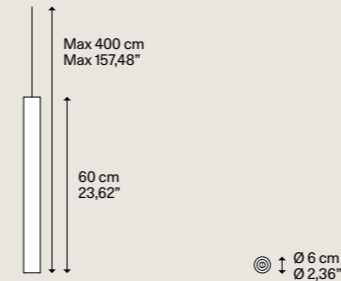

Net weight 1,42 kg
Peso netto 3,13 lbs
Pack Colli 1

Light source
Sorgente luminosa

GU10 Par 16 LED 1x 10 W
W/L max 8,5 cm
W/L max 3,34"

Bulb not included
Lampadina non inclusa

Metal structure
Montatura in metallo

Matte White - 9010
Bianco Opaco - 9010

Matte Black - 9005
Nero Opaco - 9005

Coppery Bronze
Bronzo Ramato

Code
Codice

09623 1000

09623 2000

09623 3500

VAT excluded
IVA esclusa

Euro €

250,00

250,00

265,00

CE IP20 TRIAC 220-240V ENEC DALI P. 089

A-Tube large

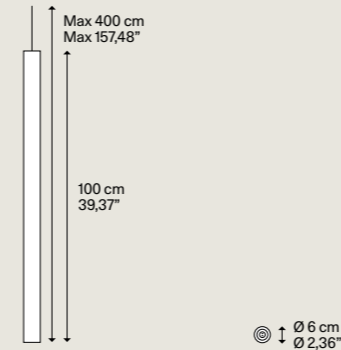

Net weight 1,87 kg
Peso netto 4,12 lbs
Pack Colli 1

Light source
Sorgente luminosa

GU10 Par 16 LED 1x 10 W
W/L max 8,5 cm
W/L max 3,34"

Bulb not included
Lampadina non inclusa

Metal structure
Montatura in metallo

Matte White - 9010
Bianco Opaco - 9010

Matte Black - 9005
Nero Opaco - 9005

Coppery Bronze
Bronzo Ramato

Code
Codice

09624 1000

09624 2000

09624 3500

VAT excluded
IVA esclusa

Euro €

347,00

347,00

368,00

CE IP20 TRIAC 220-240V ENEC DALI P. 089

Cluster suspension lamps must be installed on a canopy ▶ p. 044-051
Le lampade a sospensione cluster devono essere installate su rosone ▶ p. 044-051

SUSPENSION LAMP
CLUSTER SUSPENSION LAMP
CANOPY
WALL & CEILING LAMP
FLOOR & TABLE LAMP
ACCESSORY

A-Tube Nano small

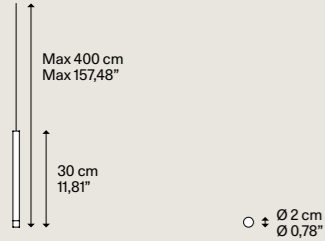

Light source Sorgente luminosa		Light source Sorgente luminosa	
A		B	
LED 2700	K	LED 3000	K
3	W	3	W
450	lm	480	lm
350	mA	350	mA
CRI 90		CRI 90	
MacAdam 3-Step		MacAdam 3-Step	
LED and driver included LED e driver inclusi		LED and driver included LED e driver inclusi	

Net weight Peso netto	0,22 kg 0,48 lbs	Pack Colli	2	Energy class Classe energetica	D
--------------------------	---------------------	---------------	---	-----------------------------------	---

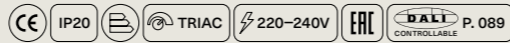

Metal structure Montatura in metallo	Methacrylate diffuser Diffusore in metacrilato	Code Codice	Code Codice	Euro €
		A	B	
Matte Black-9005 Nero Opaco-9005		15822 2020	15822 2035	154,00
Chrome Cromo		15822 4020	15822 4035	174,00
Champagne Champagne		15822 4520	15822 4535	159,00
Gold Oro	Clear Trasparente	15822 5020	15822 5035	179,00
Rose Gold Oro Rosa		15822 5520	15822 5535	179,00
Terra Terra	Transparent cable Cavo trasparente	15822 6720	15822 6735	174,00
Matte Black-9005 Nero Opaco-9005		15826 2020	15826 2035	154,00
Chrome Cromo		15826 4020	15826 4035	174,00
Champagne Champagne		15826 4520	15826 4535	159,00
Gold Oro	Clear Trasparente	15826 5020	15826 5035	179,00
Rose Gold Oro Rosa		15826 5520	15826 5535	179,00
Terra Terra	Black cable Cavo nero	15826 6720	15826 6735	174,00

A-Tube Nano large

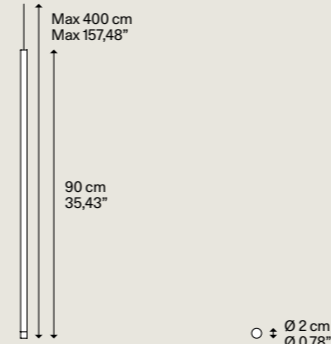

Light source Sorgente luminosa		Light source Sorgente luminosa	
A		B	
LED 2700	K	LED 3000	K
3	W	3	W
450	lm	480	lm
350	mA	350	mA
CRI 90		CRI 90	
MacAdam 3-Step		MacAdam 3-Step	
LED and driver included LED e driver inclusi		LED and driver included LED e driver inclusi	

Net weight Peso netto	0,40 kg 0,88 lbs	Pack Colli	2	Energy class Classe energetica	D
--------------------------	---------------------	---------------	---	-----------------------------------	---



Metal structure Montatura in metallo	Methacrylate diffuser Diffusore in metacrilato	Code Codice	Code Codice	Euro €
		A	B	
Matte Black-9005 Nero Opaco-9005		15824 2020	15824 2035	179,00
Chrome Cromo		15824 4020	15824 4035	214,00
Champagne Champagne		15824 4520	15824 4535	189,00
Gold Oro	Clear Trasparente	15824 5020	15824 5035	224,00
Rose Gold Oro Rosa		15824 5520	15824 5535	224,00
Terra Terra	Transparent cable Cavo trasparente	15824 6720	15824 6735	214,00
Matte Black-9005 Nero Opaco-9005		15828 2020	15828 2035	179,00
Chrome Cromo		15828 4020	15828 4035	214,00
Champagne Champagne		15828 4520	15828 4535	189,00
Gold Oro	Clear Trasparente	15828 5020	15828 5035	224,00
Rose Gold Oro Rosa		15828 5520	15828 5535	224,00
Terra Terra	Black cable Cavo nero	15828 6720	15828 6735	214,00

Cluster suspension lamps must be installed on a canopy ► P. 044-051
Le lampade a sospensione cluster devono essere installate su rosone ► P. 044-051

A-Tube Nano medium

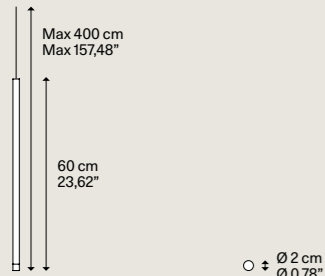

Light source Sorgente luminosa		Light source Sorgente luminosa	
A		B	
LED 2700	K	LED 3000	K
3	W	3	W
450	lm	480	lm
350	mA	350	mA
CRI 90		CRI 90	
MacAdam 3-Step		MacAdam 3-Step	
LED and driver included LED e driver inclusi		LED and driver included LED e driver inclusi	

Net weight Peso netto	0,30 kg 0,66 lbs	Pack Colli	2	Energy class Classe energetica	D
--------------------------	---------------------	---------------	---	-----------------------------------	---

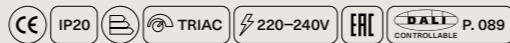

Cluster suspension lamps must be installed on a canopy ► P. 044-051
Le lampade a sospensione cluster devono essere installate su rosone ► P. 044-051

Metal structure Montatura in metallo	Methacrylate diffuser Diffusore in metacrilato	Code Codice	Code Codice	Euro €
		A	B	
Matte Black-9005 Nero Opaco-9005		15823 2020	15823 2035	169,00
Chrome Cromo		15823 4020	15823 4035	194,00
Champagne Champagne		15823 4520	15823 4535	179,00
Gold Oro	Clear Trasparente	15823 5020	15823 5035	204,00
Rose Gold Oro Rosa		15823 5520	15823 5535	204,00
Terra Terra	Transparent cable Cavo trasparente	15823 6720	15823 6735	194,00
Matte Black-9005 Nero Opaco-9005		15827 2020	15827 2035	169,00
Chrome Cromo		15827 4020	15827 4035	194,00
Champagne Champagne		15827 4520	15827 4535	179,00
Gold Oro	Clear Trasparente	15827 5020	15827 5035	204,00
Rose Gold Oro Rosa		15827 5520	15827 5535	204,00
Terra Terra	Black cable Cavo nero	15827 6720	15827 6735	194,00

A-Tube Nano Duo

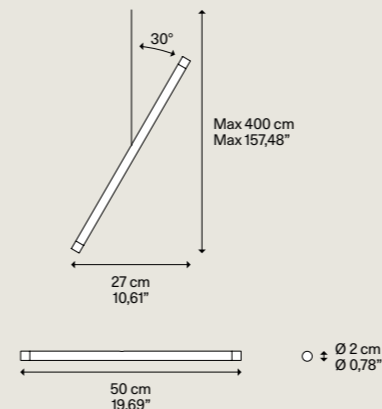

Net weight Peso netto	0,21 kg 0,46 lbs	Pack Colli	1	Energy class Classe energetica	D
--------------------------	---------------------	---------------	---	-----------------------------------	---



Cluster suspension lamps must be installed on a canopy ► P. 044-051
Le lampade a sospensione cluster devono essere installate su rosone ► P. 044-051

Metal structure Montatura in metallo	Methacrylate diffuser Diffusore in metacrilato	Code Codice	Euro €
Matte Black-9005 Nero Opaco-9005		15825 2020	184,00
Chrome Cromo		15825 4020	210,00
Champagne Champagne		15825 4520	194,00
Gold Oro	Clear Trasparente	15825 5020	225,00
Rose Gold Oro Rosa		15825 5520	225,00
Terra Terra	Transparent cable Cavo trasparente	15825 6720	210,00

Light source Sorgente luminosa	
LED 2700	K
2x 1	W
280	lm
350	mA
CRI 90	
MacAdam 3-Step	
LED and driver included LED e driver inclusi	

Cono di Luce small

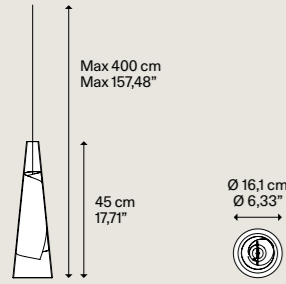

Outside blown glass diffuser
Diffusore esterno in vetro soffiato

Clear
Trasparente

Inside PCB diffuser
Diffusore interno in PCB

- Grey Grigio
- Gold Oro
- Red Rosso

Code Codice	Euro €
21010 3227	368,00
21010 5027	419,00
21010 6027	368,00

Light source
Sorgente luminosa

LED
2700 K
7 W
1307 lm
350 mA
CRI 90
MacAdam 3-Step
LED and driver included
LED e driver inclusi

Net weight Peso netto	0,73 kg 1,61 lbs	Pack Colli	3	Energy class Classe energetica	B
--------------------------	---------------------	---------------	---	-----------------------------------	---

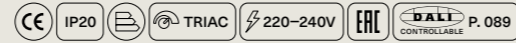

Cono di Luce large

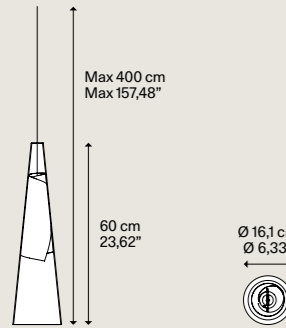

Outside blown glass diffuser
Diffusore esterno in vetro soffiato

Clear
Trasparente

Inside PCB diffuser
Diffusore interno in PCB

- Grey Grigio
- Gold Oro
- Red Rosso

Code Codice	Euro €
21011 3227	470,00
21011 5027	521,00
21011 6027	470,00

Light source
Sorgente luminosa

LED
2700 K
7 W
1307 lm
350 mA
CRI 90
MacAdam 3-Step
LED and driver included
LED e driver inclusi

Net weight Peso netto	1,12 kg 2,47 lbs	Pack Colli	3	Energy class Classe energetica	B
--------------------------	---------------------	---------------	---	-----------------------------------	---

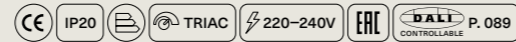

Cluster suspension lamps must be installed on a canopy ▶ P. 044-051
Le lampade a sospensione cluster devono essere installate su rosone ▶ P. 044-051

IVY I

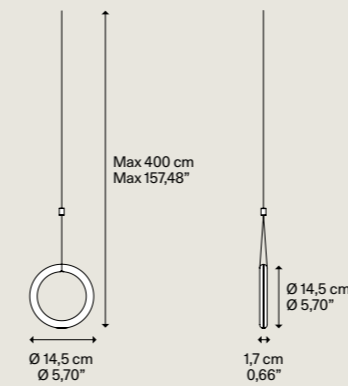

Metal structure
Montatura in metallo

- Matte Black-9005
Nero Opaco-9005
- Extra Matte Champagne
Champagne Extra Opaco
- Terra
Terra

Cable
Cavo

Black
Nero

Code Codice	A Code Codice	B Code Codice	Euro €
17810 2020	17810 2035		169,00
17810 4520	17810 4535		180,00
17810 6720	17810 6735		190,00

Light source
Sorgente luminosa

LED
2700 K
3 W
450 lm
350 mA
CRI 90
MacAdam 3-Step
LED and driver included
LED e driver inclusi

Light source
Sorgente luminosa

LED
3000 K
3 W
480 lm
350 mA
CRI 90
MacAdam 3-Step
LED and driver included
LED e driver inclusi

Net weight Peso netto	0,50 kg 1,10 lbs	Pack Colli	1	Energy class Classe energetica	2700 K ▶ D 3000 K ▶ C
--------------------------	---------------------	---------------	---	-----------------------------------	--------------------------

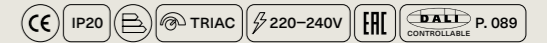

Cluster suspension lamps must be installed on a canopy ▶ P. 044-051
Le lampade a sospensione cluster devono essere installate su rosone ▶ P. 044-051

Jefferson mini

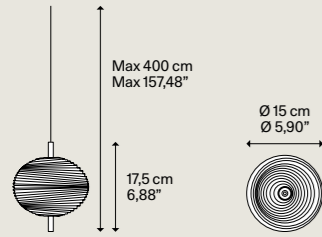

Metal structure Montatura in metallo

- Black Chrome
Cromo Nero
- Gold
Oro

Bohemian crystal diffuser Diffusore in cristallo di Boemia

- Clear
Trasparente

Code Codice	Euro €
16821 4227	286,00
16821 5027	296,00

Light source Sorgente luminosa

LED
2700 K
3 W
450 lm
350 mA
CRI 90
MacAdam 3-Step

LED and driver included
LED e driver inclusi

Net weight Peso netto	1,40 kg 3,09 lbs	Pack Colli	1	Energy class Classe energetica	D
--------------------------	---------------------	---------------	---	-----------------------------------	---

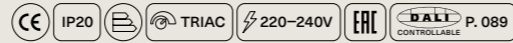

Jefferson small

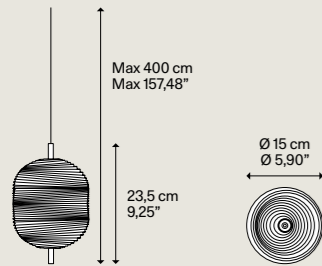

Metal structure Montatura in metallo

- Black Chrome
Cromo Nero
- Gold
Oro

Bohemian crystal diffuser Diffusore in cristallo di Boemia

- Clear
Trasparente

Code Codice	Euro €
16822 4227	368,00
16822 5027	378,00

Light source Sorgente luminosa

LED
2700 K
3 W
450 lm
350 mA
CRI 90
MacAdam 3-Step

LED and driver included
LED e driver inclusi

Net weight Peso netto	2,10 kg 4,63 lbs	Pack Colli	1	Energy class Classe energetica	D
--------------------------	---------------------	---------------	---	-----------------------------------	---

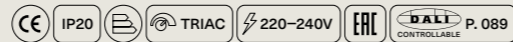

Cluster suspension lamps must be installed on a canopy ▶ p. 044-051
Le lampade a sospensione cluster devono essere installate su rosone ▶ p. 044-051

JIM bell

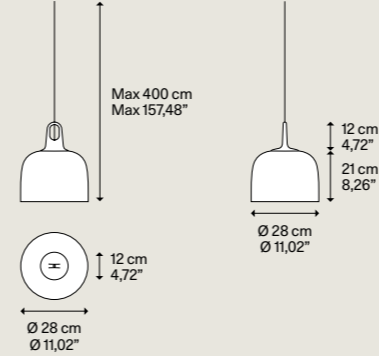

Outside metal diffuser Diff. esterno in metallo

- Matte Black-9005
Nero Opaco-9005

Inside metal diffuser Diff. interno in metallo

- Matte White-9010
Bianco Opaco-9010

Hook methacrylate Gancio in metacrilato

- Grey
Grigio
- Honey
Miele
- Grey
Grigio
- Honey
Miele

Code Codice	Euro €
16921 2800	322,00
16921 6600	322,00
16921 2700	332,00
16921 6500	332,00

Light source Sorgente luminosa

E27 A60 LED
1x Max 25 W

Bulb not included
Lampadina non inclusa

Net weight Peso netto	1,90 kg 4,19 lbs	Pack Colli	2
--------------------------	---------------------	---------------	---

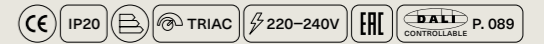

JIM cone

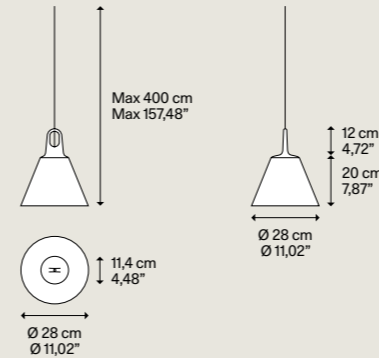

Outside metal diffuser Diff. esterno in metallo

- Matte Black-9005
Nero Opaco-9005

Inside metal diffuser Diff. interno in metallo

- Matte White-9010
Bianco Opaco-9010

Hook methacrylate Gancio in metacrilato

- Grey
Grigio
- Honey
Miele
- Grey
Grigio
- Honey
Miele

Code Codice	Euro €
16922 2800	276,00
16922 6600	276,00
16922 2700	286,00
16922 6500	286,00

Light source Sorgente luminosa

E27 A60 LED
1x Max 25 W

Bulb not included
Lampadina non inclusa

Net weight Peso netto	1,00 kg 2,20 lbs	Pack Colli	2
--------------------------	---------------------	---------------	---

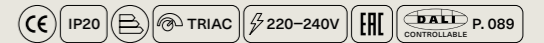

JIM cylinder

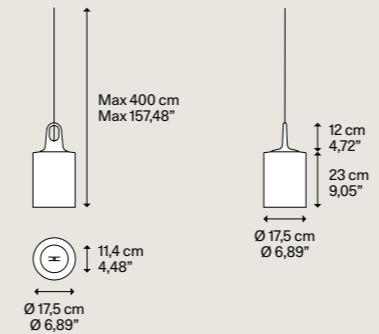

Outside metal diffuser Diff. esterno in metallo

- Matte Black-9005
Nero Opaco-9005

Inside metal diffuser Diff. interno in metallo

- Matte White-9010
Bianco Opaco-9010

Hook methacrylate Gancio in metacrilato

- Grey
Grigio
- Honey
Miele
- Grey
Grigio
- Honey
Miele

Code Codice	Euro €
16923 2800	290,00
16923 6600	290,00
16923 2700	300,00
16923 6500	300,00

Light source Sorgente luminosa

E27 A60 LED
1x Max 25 W

Bulb not included
Lampadina non inclusa

Net weight Peso netto	1,40 kg 3,09 lbs	Pack Colli	2
--------------------------	---------------------	---------------	---

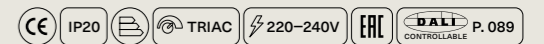

Cluster suspension lamps must be installed on a canopy ▶ p. 044-051
Le lampade a sospensione cluster devono essere installate su rosone ▶ p. 044-051

Kelly Cluster

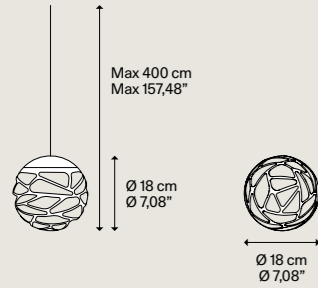

Metal structure Montatura in metallo	Glass diffuser Diffusore in vetro	Code Codice	Euro €
Matte White - 9010 Bianco Opaco - 9010	Glossy White Bianco Lucido	14711 1027	388,00
Matte Black - 9005 Nero Opaco - 9005		14711 2027	388,00
Coppery Bronze Bronzo Ramato		14711 3527	403,00
Champagne Champagne		14711 4527	403,00

Light source
Sorgente luminosa

LED
2700 K
7 W
1280 lm
350 mA
CRI 90
MacAdam 3-Step

LED and driver included
LED e driver inclusi

Net weight Peso netto	1,00 kg 2,20 lbs	Pack Colli	1	Energy class Classe energetica	C
--------------------------	---------------------	---------------	---	-----------------------------------	---

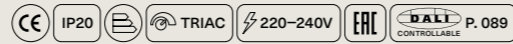

Cluster suspension lamps must be installed on a canopy ▶ p. 044-051
Le lampade a sospensione cluster devono essere installate su rosone ▶ p. 044-051

Nostalgia small

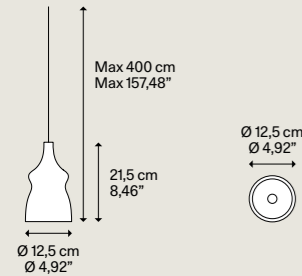

Metal structure Montatura in metallo	Blown glass diffuser Diffusore in vetro soffiato	Code Codice	Euro €
Chrome Cromo	Clear Trasparente	15412 0027	317,00
	Glossy Smoke Fumo Lucido	15412 4327	378,00
	Glossy Bronze Bronzo Lucido	15412 4627	378,00
	Gold Oro	15412 5027	378,00
White fabric cable Cavo bianco in tessuto	Rose Gold Oro Rosa	15412 5527	378,00
	Clear Trasparente	15415 0027	317,00
Matte Black - 9005 Nero Opaco - 9005	Glossy Smoke Fumo Lucido	15415 4327	378,00
	Glossy Bronze Bronzo Lucido	15415 4627	378,00
	Gold Oro	15415 5027	378,00
	Rose Gold Oro Rosa	15415 5527	378,00
Black fabric cable Cavo nero in tessuto	Clear Trasparente	15415 0027	317,00
	Glossy Smoke Fumo Lucido	15415 4327	378,00

Light source
Sorgente luminosa

LED
2700 K
7 W
1280 lm
350 mA
CRI 90
MacAdam 3-Step

LED and driver included
LED e driver inclusi

Net weight Peso netto	0,66 kg 1,46 lbs	Pack Colli	2	Energy class Classe energetica	C
--------------------------	---------------------	---------------	---	-----------------------------------	---

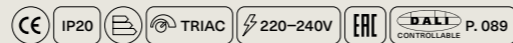

Cluster suspension lamps must be installed on a canopy ▶ p. 044-051
Le lampade a sospensione cluster devono essere installate su rosone ▶ p. 044-051

Nostalgia medium

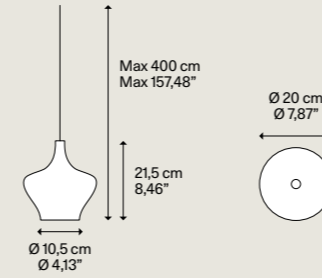

Metal structure Montatura in metallo	Blown glass diffuser Diffusore in vetro soffiato	Code Codice	Euro €
Chrome Cromo	Clear Trasparente	15413 0027	368,00
	Glossy Smoke Fumo Lucido	15413 4327	429,00
	Glossy Bronze Bronzo Lucido	15413 4627	429,00
	Gold Oro	15413 5027	429,00
White fabric cable Cavo bianco in tessuto	Rose Gold Oro Rosa	15413 5527	429,00
	Clear Trasparente	15416 0027	368,00
Matte Black - 9005 Nero Opaco - 9005	Glossy Smoke Fumo Lucido	15416 4327	429,00
	Glossy Bronze Bronzo Lucido	15416 4627	429,00
	Gold Oro	15416 5027	429,00
	Rose Gold Oro Rosa	15416 5527	429,00
Black fabric cable Cavo nero in tessuto	Clear Trasparente	15416 0027	368,00
	Glossy Smoke Fumo Lucido	15416 4327	429,00

Light source
Sorgente luminosa

LED
2700 K
7 W
1280 lm
350 mA
CRI 90
MacAdam 3-Step

LED and driver included
LED e driver inclusi

Net weight Peso netto	0,75 kg 1,65 lbs	Pack Colli	2	Energy class Classe energetica	C
--------------------------	---------------------	---------------	---	-----------------------------------	---

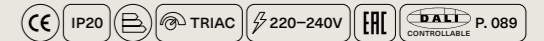

Cluster suspension lamps must be installed on a canopy ▶ p. 044-051
Le lampade a sospensione cluster devono essere installate su rosone ▶ p. 044-051

Oblò small

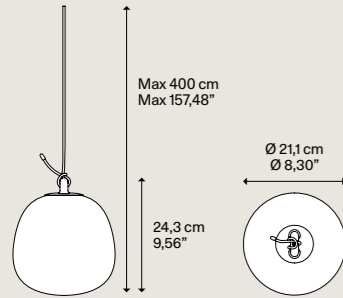

Silicone hook Gancio in silicone	Blown glass diffuser Diffusore in vetro soffiato	Code Codice	Code Codice	Euro €
White Bianco	Clear Trasparente	21811 0027	21811 0030	330,00
	Silk White NEW Bianco Seta	21811 1327	21811 1330	450,00
	Rainbow NEW Iridescente	21811 0127	21811 0130	550,00
	Glossy Smoke Fumo Lucido	21811 4327	21811 4330	450,00
	Azure Steel NEW Azzurro Metallizzato	21811 8627	21811 8630	450,00

**Light source
Sorgente luminosa**

LED
2700 K
7 W
1280 lm
350 mA
CRI 90
MacAdam 3-Step

LED and driver included
LED e driver inclusi

**Light source
Sorgente luminosa**

LED
3000 K
7 W
1300 lm
350 mA
CRI 90
MacAdam 3-Step

LED and driver included
LED e driver inclusi

Net weight 0,64 kg / 1,41 lbs
Pack Colli 2
Energy class Classe energetica D

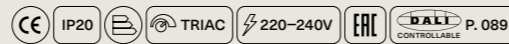

NEW LAMP

Oblò medium

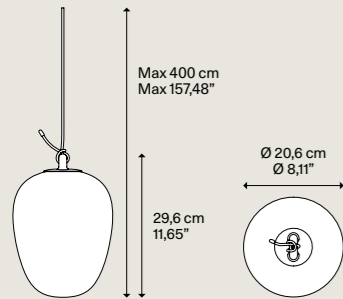

Silicone hook Gancio in silicone	Blown glass diffuser Diffusore in vetro soffiato	Code Codice	Code Codice	Euro €
White Bianco	Clear Trasparente	21812 0027	21812 0030	365,00
	Silk White NEW Bianco Seta	21812 1327	21812 1330	495,00
	Rainbow NEW Iridescente	21812 0127	21812 0130	595,00
	Glossy Smoke Fumo Lucido	21812 4327	21812 4330	495,00
	Azure Steel NEW Azzurro Metallizzato	21812 8627	21812 8630	495,00

**Light source
Sorgente luminosa**

LED
2700 K
7 W
1280 lm
350 mA
CRI 90
MacAdam 3-Step

LED and driver included
LED e driver inclusi

**Light source
Sorgente luminosa**

LED
3000 K
7 W
1300 lm
350 mA
CRI 90
MacAdam 3-Step

LED and driver included
LED e driver inclusi

Net weight 0,69 kg / 1,52 lbs
Pack Colli 2
Energy class Classe energetica D

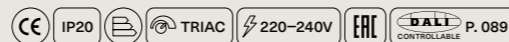

Cluster suspension lamps must be installed on a canopy ▶ p. 044-051
Le lampade a sospensione cluster devono essere installate su rosone ▶ p. 044-051

Oblò large

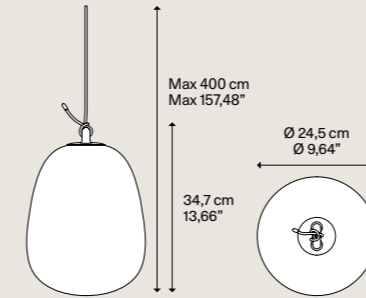

Silicone hook Gancio in silicone	Blown glass diffuser Diffusore in vetro soffiato	Code Codice	Code Codice	Euro €
White Bianco	Clear Trasparente	21813 0027	21813 0030	420,00
	Silk White NEW Bianco Seta	21813 1327	21813 1330	560,00
	Rainbow NEW Iridescente	21813 0127	21813 0130	690,00
	Glossy Smoke Fumo Lucido	21813 4327	21813 4330	560,00
	Azure Steel NEW Azzurro Metallizzato	21813 8627	21813 8630	560,00

**Light source
Sorgente luminosa**

LED
2700 K
7 W
1280 lm
350 mA
CRI 90
MacAdam 3-Step

LED and driver included
LED e driver inclusi

**Light source
Sorgente luminosa**

LED
3000 K
7 W
1300 lm
350 mA
CRI 90
MacAdam 3-Step

LED and driver included
LED e driver inclusi

Net weight 0,82 kg / 1,80 lbs
Pack Colli 2
Energy class Classe energetica D



Cluster suspension lamps must be installed on a canopy ▶ p. 044-051
Le lampade a sospensione cluster devono essere installate su rosone ▶ p. 044-051

Rain

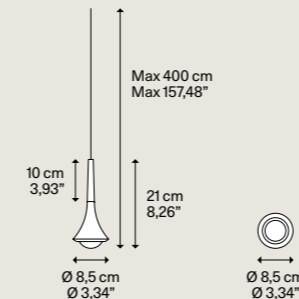

**Light source
Sorgente luminosa**

LED
2700 K
7 W
1280 lm
350 mA
CRI 90
MacAdam 3-Step

LED and driver included
LED e driver inclusi

**Light source
Sorgente luminosa**

LED
3000 K
7 W
1300 lm
350 mA
CRI 90
MacAdam 3-Step

LED and driver included
LED e driver inclusi

Net weight 0,34 kg / 0,75 lbs
Pack Colli 2
Energy class Classe energetica C

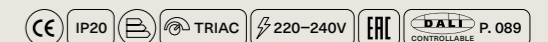

Cluster suspension lamps must be installed on a canopy ▶ p. 044-051
Le lampade a sospensione cluster devono essere installate su rosone ▶ p. 044-051

Metal structure Montatura in metallo	Metal decor Decoro in metallo	Code Codice	Code Codice	Euro €	
Chrome Cromo	Matte Black -9005 Nero Opaco-9005	15611 2027	15611 2030	184,00	
	Coppery Bronze Bronzo Ramato	15611 3527	15611 3530	189,00	
	Brushed Chrome Cromo Spazzolato	15611 4727	15611 4730	199,00	
	Gold Oro	15611 5027	15611 5030	199,00	
	Rose Gold Oro Rosa	15611 5527	15611 5530	199,00	
	Transparent cable Cavo trasparente	Matte Black -9005 Nero Opaco-9005	15612 2027	15612 2030	184,00
		Coppery Bronze Bronzo Ramato	15612 3527	15612 3530	189,00
		Brushed Chrome Cromo Spazzolato	15612 4727	15612 4730	199,00
		Gold Oro	15612 5027	15612 5030	199,00
		Rose Gold Oro Rosa	15612 5527	15612 5530	199,00
Black cable Cavo nero	Matte Black -9005 Nero Opaco-9005	15611 2027	15611 2030	184,00	
	Coppery Bronze Bronzo Ramato	15611 3527	15611 3530	189,00	

Random

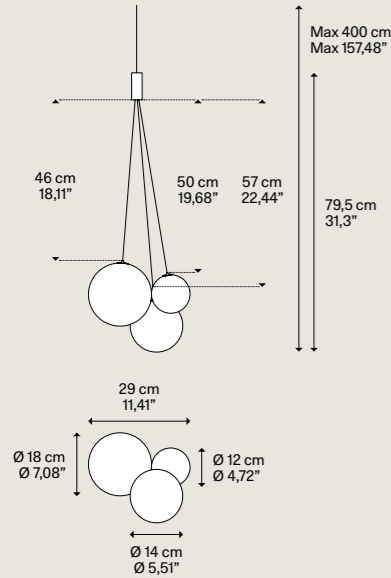

Metal structure Montatura in metallo	Blown glass diffuser Diffusore in vetro soffiato	Code Codice	Code Codice	Euro €
Chrome Cromo	Clear Trasparente	16410 0027	16410 0030	266,00
	Frosted White Bianco Satinato	16410 1327	16410 1330	378,00
	Chrome Cromo	16410 4027	16410 4030	378,00
	Glossy Smoke Fumo Lucido	16410 4327	16410 4330	378,00
	Glossy Bronze Bronzo Lucido	16410 4627	16410 4630	378,00
	Gold Oro	16410 5027	16410 5030	378,00
	Rose Gold Oro Rosa	16410 5527	16410 5530	378,00

Light source Sorgente luminosa	
LED	2700 K
3x 1	W
450	lm
350	mA
CRI 90	
MacAdam 3-Step	
LED and driver included LED e driver inclusi	

Light source Sorgente luminosa	
LED	3000 K
3x 1	W
480	lm
350	mA
CRI 90	
MacAdam 3-Step	
LED and driver included LED e driver inclusi	

Net weight Peso netto	0,88 kg 1,94 lbs	Pack Colli	2	Energy class Classe energetica	D
--------------------------	---------------------	---------------	---	-----------------------------------	---

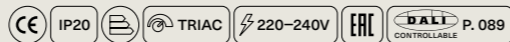

Cluster suspension lamps must be installed on a canopy ► P. 044-051
Le lampade a sospensione cluster devono essere installate su rosone ► P. 044-051

Random Solo 10

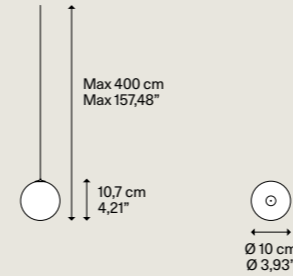

Blown glass diffuser Diffusore in vetro soffiato	Code Codice	Code Codice	Euro €
Clear Trasparente	17110 0027	17110 0030	100,00
Frosted White Bianco Satinato	17110 1327	17110 1330	123,00
Chrome Cromo	17110 4027	17110 4030	123,00
Glossy Smoke Fumo Lucido	17110 4327	17110 4330	123,00
Glossy Bronze Bronzo Lucido	17110 4627	17110 4630	123,00
Gold Oro	17110 5027	17110 5030	123,00
Rose Gold Oro Rosa	17110 5527	17110 5530	123,00

Light source Sorgente luminosa	
LED	2700 K
1	W
150	lm
350	mA
CRI 90	
MacAdam 3-Step	
LED and driver included LED e driver inclusi	

Light source Sorgente luminosa	
LED	3000 K
1	W
160	lm
350	mA
CRI 90	
MacAdam 3-Step	
LED and driver included LED e driver inclusi	

Net weight Peso netto	0,165 kg 0,363 lbs	Pack Colli	2	Energy class Classe energetica	D
--------------------------	-----------------------	---------------	---	-----------------------------------	---

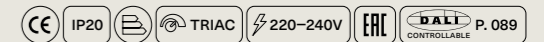

Random Solo 12

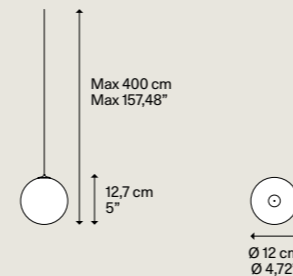

Blown glass diffuser Diffusore in vetro soffiato	Code Codice	Code Codice	Euro €
Clear Trasparente	17111 0027	17111 0030	123,00
Frosted White Bianco Satinato	17111 1327	17111 1330	148,00
Chrome Cromo	17111 4027	17111 4030	148,00
Glossy Smoke Fumo Lucido	17111 4327	17111 4330	148,00
Glossy Bronze Bronzo Lucido	17111 4627	17111 4630	148,00
Gold Oro	17111 5027	17111 5030	148,00
Rose Gold Oro Rosa	17111 5527	17111 5530	148,00

Light source Sorgente luminosa	
LED	2700 K
1	W
150	lm
350	mA
CRI 90	
MacAdam 3-Step	
LED and driver included LED e driver inclusi	

Light source Sorgente luminosa	
LED	3000 K
1	W
160	lm
350	mA
CRI 90	
MacAdam 3-Step	
LED and driver included LED e driver inclusi	

Net weight Peso netto	0,20 kg 0,44 lbs	Pack Colli	2	Energy class Classe energetica	D
--------------------------	---------------------	---------------	---	-----------------------------------	---

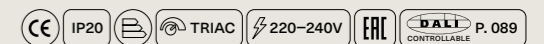

Cluster suspension lamps must be installed on a canopy ► P. 044-051
Le lampade a sospensione cluster devono essere installate su rosone ► P. 044-051

SUSPENSION LAMP
CLUSTER SUSPENSION LAMP
CANOPY
WALL & CEILING LAMP
FLOOR & TABLE LAMP
ACCESSORY

Random Solo 14

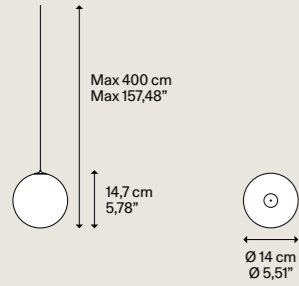

Blown glass diffuser
Diffusore in vetro soffiato

	Code Codice A	Code Codice B	Euro €
Clear Trasparente	17112 0027	17112 0030	128,00
Frosted White Bianco Satinato	17112 1327	17112 1330	159,00
Chrome Cromo	17112 4027	17112 4030	159,00
Glossy Smoke Fumo Lucido	17112 4327	17112 4330	159,00
Glossy Bronze Bronzo Lucido	17112 4627	17112 4630	159,00
Gold Oro	17112 5027	17112 5030	159,00
Rose Gold Oro Rosa	17112 5527	17112 5530	159,00

Light source
Sorgente luminosa **A**

LED
2700 K
1 W
150 lm
350 mA
CRI 90
MacAdam 3-Step

LED and driver included
LED e driver inclusi

Light source
Sorgente luminosa **B**

LED
3000 K
1 W
160 lm
350 mA
CRI 90
MacAdam 3-Step

LED and driver included
LED e driver inclusi

Net weight 0,22 kg / 0,48 lbs
Pack Colli 2
Energy class Classe energetica D

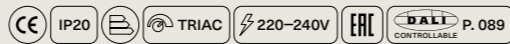

Random Solo 23

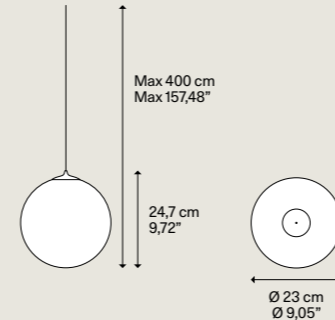

Blown glass diffuser
Diffusore in vetro soffiato

	Code Codice A	Code Codice B	Euro €
Clear Trasparente	17114 0027	17114 0030	235,00
Frosted White Bianco Satinato	17114 1327	17114 1330	357,00
Chrome Cromo	17114 4027	17114 4030	357,00
Glossy Smoke Fumo Lucido	17114 4327	17114 4330	357,00
Glossy Bronze Bronzo Lucido	17114 4627	17114 4630	357,00
Gold Oro	17114 5027	17114 5030	357,00
Rose Gold Oro Rosa	17114 5527	17114 5530	357,00

Light source
Sorgente luminosa **A**

LED
2700 K
3 W
450 lm
350 mA
CRI 90
MacAdam 3-Step

LED and driver included
LED e driver inclusi

Light source
Sorgente luminosa **B**

LED
3000 K
3 W
480 lm
350 mA
CRI 90
MacAdam 3-Step

LED and driver included
LED e driver inclusi

Net weight 0,60 kg / 1,32 lbs
Pack Colli 2
Energy class Classe energetica D



Random Solo 18

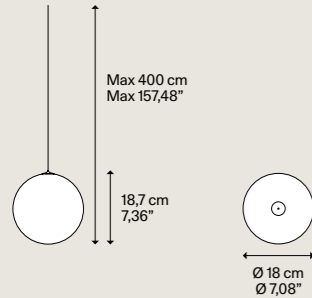

Blown glass diffuser
Diffusore in vetro soffiato

	Code Codice A	Code Codice B	Euro €
Clear Trasparente	17113 0027	17113 0030	143,00
Frosted White Bianco Satinato	17113 1327	17113 1330	174,00
Chrome Cromo	17113 4027	17113 4030	174,00
Glossy Smoke Fumo Lucido	17113 4327	17113 4330	174,00
Glossy Bronze Bronzo Lucido	17113 4627	17113 4630	174,00
Gold Oro	17113 5027	17113 5030	174,00
Rose Gold Oro Rosa	17113 5527	17113 5530	174,00

Light source
Sorgente luminosa **A**

LED
2700 K
1 W
150 lm
350 mA
CRI 90
MacAdam 3-Step

LED and driver included
LED e driver inclusi

Light source
Sorgente luminosa **B**

LED
3000 K
1 W
160 lm
350 mA
CRI 90
MacAdam 3-Step

LED and driver included
LED e driver inclusi

Net weight 0,35 kg / 0,77 lbs
Pack Colli 2
Energy class Classe energetica D



Random Solo 28

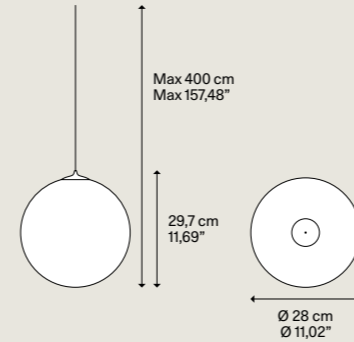

Blown glass diffuser
Diffusore in vetro soffiato

	Code Codice A	Code Codice B	Euro €
Clear Trasparente	17115 0027	17115 0030	276,00
Frosted White Bianco Satinato	17115 1327	17115 1330	398,00
Chrome Cromo	17115 4027	17115 4030	398,00
Glossy Smoke Fumo Lucido	17115 4327	17115 4330	398,00
Glossy Bronze Bronzo Lucido	17115 4627	17115 4630	398,00
Gold Oro	17115 5027	17115 5030	398,00
Rose Gold Oro Rosa	17115 5527	17115 5530	398,00

Light source
Sorgente luminosa **A**

LED
2700 K
3 W
450 lm
350 mA
CRI 90
MacAdam 3-Step

LED and driver included
LED e driver inclusi

Light source
Sorgente luminosa **B**

LED
3000 K
3 W
480 lm
350 mA
CRI 90
MacAdam 3-Step

LED and driver included
LED e driver inclusi

Net weight 0,90 kg / 1,98 lbs
Pack Colli 2
Energy class Classe energetica D



Cluster suspension lamps must be installed on a canopy ▶ P. 044-051
Le lampade a sospensione cluster devono essere installate su rosone ▶ P. 044-051

Cluster suspension lamps must be installed on a canopy ▶ P. 044-051
Le lampade a sospensione cluster devono essere installate su rosone ▶ P. 044-051

Spider

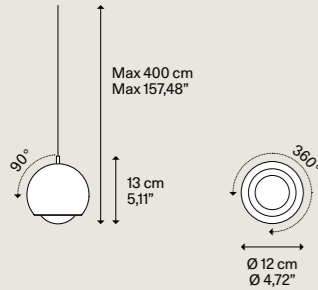

Metal structure Montatura in metallo	Metal diffuser Diffusore in metallo	Code Codice	Code Codice	Euro €
Chrome Cromo	Matte White-9010 Bianco Opaco-9010	16010 1027	16010 1030	255,00
	Matte Black-9005 Nero Opaco-9005	16010 2027	16010 2030	255,00
	Extra Matte Champagne Champagne Extra Opaco	16010 4527	16010 4530	270,00
	Gold Oro	16010 5027	16010 5030	280,00
	Rose Gold Oro Rosa	16010 5527	16010 5530	280,00
	Terra Terra	16010 6727	16010 6730	280,00

Light source Sorgente luminosa	Light source Sorgente luminosa
LED 2700 K 11 W 1280 lm 350 mA CRI 90 MacAdam 3-Step LED and driver included LED e driver inclusi	LED 3000 K 11 W 1300 lm 350 mA CRI 90 MacAdam 3-Step LED and driver included LED e driver inclusi

Adjustable light
Luce orientabile

Net weight Peso netto	0,80 kg 1,76 lbs	Pack Colli	2	Energy class Classe energetica	C
--------------------------	---------------------	---------------	---	-----------------------------------	---



Cluster suspension lamps must be installed on a canopy ▶ p. 044-051
Le lampade a sospensione cluster devono essere installate su rosone ▶ p. 044-051

Volum 14

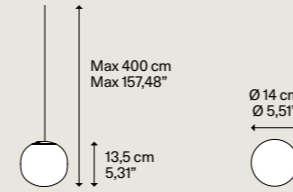

Methacrylate structure Struttura in metacrilato	Blown glass diffuser Diffusore in vetro soffiato	Code Codice	Euro €
Glossy White Bianco Lucido	Glossy White Bianco Lucido	18711 1200	174,00

Light source
Sorgente luminosa
E14 LED T18 1x 5 W (max 10 W) Ø max 6 cm Ø max 2,36" W/L max 8 cm W/L max 3,14"
Bulb not included
Lampadina non inclusa

Net weight Peso netto	0,90 kg 1,98 lbs	Pack Colli	2
--------------------------	---------------------	---------------	---



Volum 22

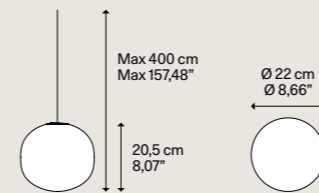

Methacrylate structure Struttura in metacrilato	Blown glass diffuser Diffusore in vetro soffiato	Code Codice	Euro €
Glossy White Bianco Lucido	Glossy White Bianco Lucido	18712 1200	260,00

Light source
Sorgente luminosa
E27 LED T28 1x 10 W (max 25 W) Ø max 6 cm Ø max 2,36" W/L max 11 cm W/L max 4,33"
Bulb not included
Lampadina non inclusa

Net weight Peso netto	1,30 kg 2,86 lbs	Pack Colli	2
--------------------------	---------------------	---------------	---

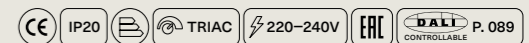

Volum 29

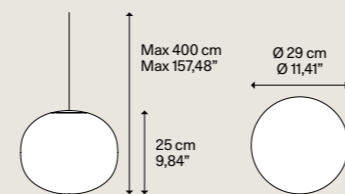

Methacrylate structure Struttura in metacrilato	Blown glass diffuser Diffusore in vetro soffiato	Code Codice	Euro €
Glossy White Bianco Lucido	Glossy White Bianco Lucido	18713 1200	327,00

Light source
Sorgente luminosa
E27 LED T35 1x 13 W (max 25 W) Ø max 9,8 cm Ø max 3,74"
Bulb not included
Lampadina non inclusa

Net weight Peso netto	2,12 kg 4,67 lbs	Pack Colli	2
--------------------------	---------------------	---------------	---

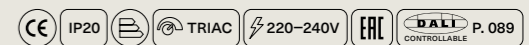

Cluster suspension lamps must be installed on a canopy ▶ p. 044-051
Le lampade a sospensione cluster devono essere installate su rosone ▶ p. 044-051

Light source Sorgente luminosa	Bulb dimension Dimensione lampadina	Lamp Lampada	Pack Colli	Code Codice	Euro €
E14 LED T18 5 W 2700 K 500 lm CRI 90 MacAdam 3-Step	Ø 1,8 cm Ø 0,70" W/L 6,1 cm W/L 2,40"	Volum 14	1	LAM-0017	24,00
E27 LED T28 10 W 2700 K 1000 lm CRI 90 MacAdam 3-Step	Ø 2,8 cm Ø 1,10" W/L 11,3 cm W/L 4,44"	Volum 22	1	LAM-0014	29,00
E27 LED T35 13 W 2700 K 1500 lm CRI 90 MacAdam 3-Step	Ø 3,5 cm Ø 1,37" W/L 15 cm W/L 5,90"	Volum 29	1	LAM-0015	39,00

Dimmable bulbs/Lampadine dimmerabili

Lodes' Canopy Systems

Single Systems

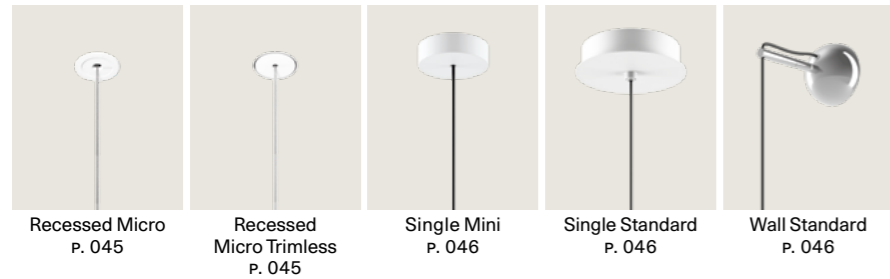

Multiple Systems

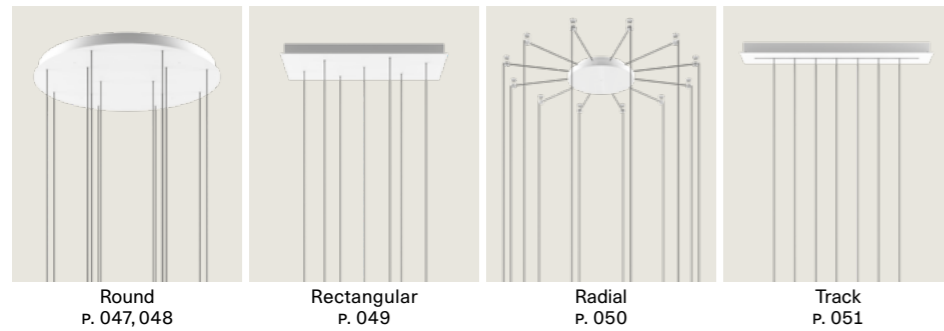

CATEGORY RECESSED CANOPY

Recessed Micro

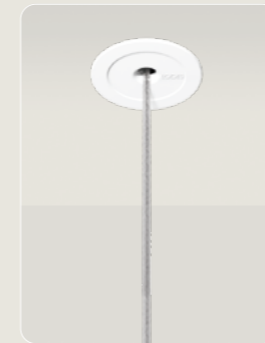
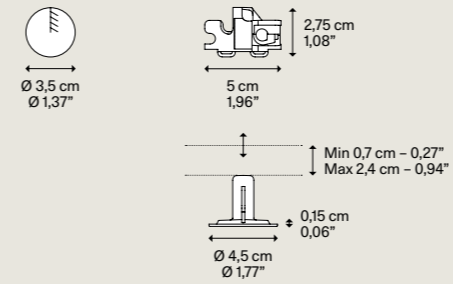

Net weight 0,015 kg Pack 1
Peso netto 0,033 lbs Colli 1

Description Descrizione	Methacrylate structure Struttura in metacrilato	System Sistema	Code Codice	Euro €	VAT excluded IVA esclusa
Recessed canopy for single lamp max capacity 3,5 kg - 7,71 lbs	Matte White - 9010* Bianco Opaco - 9010*	Recessed	R01L01 1000	26,00	
	Matte Black - 9005 Nero Opaco - 9005		R01L01 2000	26,00	
Rosone da incasso per lampada singola portata max 3,5 kg - 7,71 lbs	Chrome Cromo		R01L01 4000	31,00	

* Paintable with mural paint
Verniciabile con pittura murale



CATEGORY RECESSED CANOPY

Recessed Micro Trimless

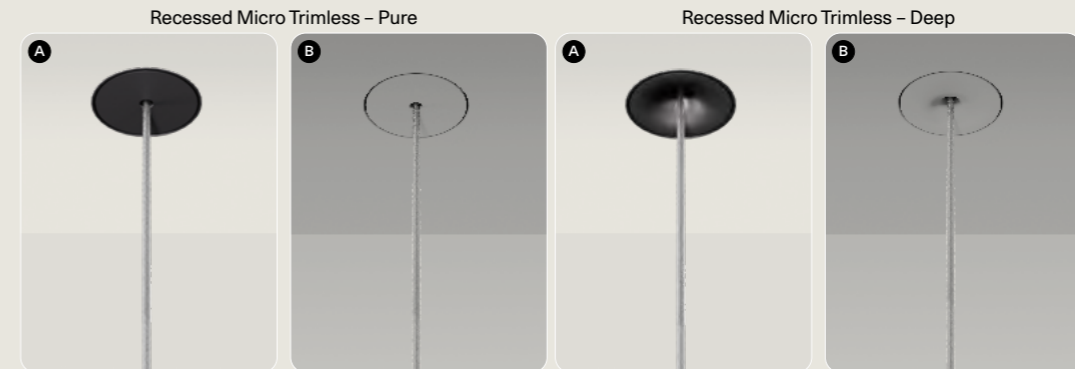
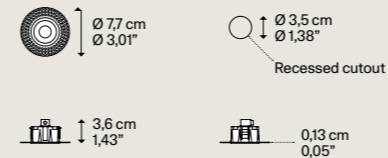

- A Recessed Micro Trimless ▾ Not painted
- B Recessed Micro Trimless ▾ Painted

Net weight 0,12 kg Pack 1
Peso netto 0,26 lbs Colli 1

Description Descrizione	Methacrylate structure Struttura in metacrilato	System Sistema	Code Codice	Euro €	VAT excluded IVA esclusa
Recessed canopy Trimless available in Pure and Deep versions for single lamp.	Matte White - 9010* Bianco Opaco - 9010*	Recessed	R13L01 1000	28,00	
	Matte Black - 9005 Nero Opaco - 9005		R13L01 2000	28,00	

* Paintable with mural paint
Verniciabile con pittura murale



Recessed Micro ▶ Suitable for ceilings up to 2,4 cm - 0,94" thickness.
Recessed Micro Trimless ▶ Suitable for ceilings up to max 2,2 cm - 0,85" thickness.

Recessed Micro ▶ Adatta per soffitti fino a 2,4 cm - 0,94" di spessore.
Recessed Micro Trimless ▶ Adatto per soffitti fino a max 2,2 cm - 0,85" di spessore.

CATEGORY SINGLE CANOPY

Single Mini

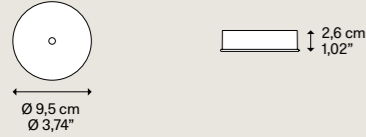

Net weight 0,13 kg / 0,28 lbs
Pack Colli 1

Description Descrizione	Methacrylate structure Struttura in metacrilato	System Sistema	Code Codice	Euro €	VAT excluded IVA esclusa
Single ceiling canopy small size	Matte White - 9010 * Bianco Opaco - 9010 *	Single	R11L01 1000	43,00	
	Matte Black - 9005 Nero Opaco - 9005		R11L01 2000	43,00	
Rosone per lampada singola versione mini	Coppery Bronze Bronzo Ramato		R11L01 3500	49,00	
	Chrome Cromo		R11L01 4000	56,00	
	Champagne Champagne		R11L01 4500	49,00	

* Paintable with mural paint
Verniciabile con pittura murale

CE IP20

CATEGORY SINGLE CANOPY

Single Standard

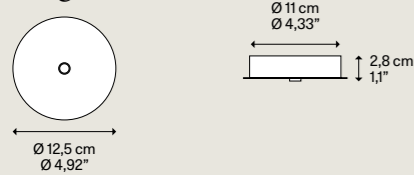

Net weight 0,40 kg / 0,88 lbs
Pack Colli 1

Description Descrizione	Metal structure Struttura in metallo	System Sistema	Code Codice	Euro €	VAT excluded IVA esclusa
Single ceiling canopy standard size	Matte White - 9010 Bianco Opaco - 9010	Single	R03L01 1000	64,00	
Rosone per lampada singola versione standard					

CE IP20

CATEGORY WALL CANOPY

Wall Standard

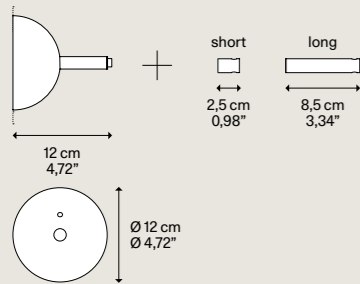

Net weight 0,40 kg / 0,88 lbs
Pack Colli 1

Description Descrizione	Metal structure Montatura in metallo	System Sistema	Code Codice	Euro €	VAT excluded IVA esclusa
Wall canopy for suspension modular system	Chrome Cromo	Wall	R12L01 4000	118,00	
Rosone a parete per sistema modulare a sospensione					

CE IP20

Wall Standard ► Both accessories in the two available lengths are supplied in the box with the wall bracket.

Wall Standard ► Entrambi gli accessori nelle due diverse lunghezze sono inclusi nella confezione con il supporto a parete.

CATEGORY CLUSTER CANOPY

3 Lights Round

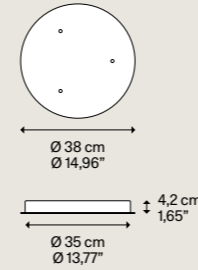

Net weight 3,55 kg / 7,82 lbs
Pack Colli 1

Description Descrizione	Metal structure Struttura in metallo	System Sistema	Code Codice	Euro €	VAT excluded IVA esclusa
Round canopy for 3 suspensions	Matte White - 9010 Bianco Opaco - 9010	Cluster	R04L03 1000	276,00	
Rosone circolare per 3 sospensioni	Matte Black - 9005 Nero Opaco - 9005		R04L03 2000	276,00	

CE IP20

5 Lights Round

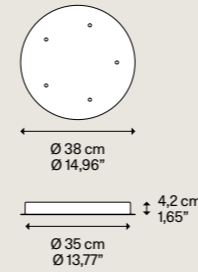

Net weight 3,55 kg / 7,82 lbs
Pack Colli 1

Description Descrizione	Metal structure Struttura in metallo	System Sistema	Code Codice	Euro €	VAT excluded IVA esclusa
Round canopy for 5 suspensions	Matte White - 9010 Bianco Opaco - 9010	Cluster	R04L05 1000	317,00	
Rosone circolare per 5 sospensioni	Matte Black - 9005 Nero Opaco - 9005		R04L05 2000	317,00	

CE IP20

7 Lights Round

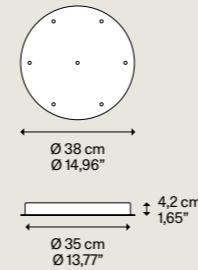

Net weight 3,55 kg / 7,82 lbs
Pack Colli 1

Description Descrizione	Metal structure Struttura in metallo	System Sistema	Code Codice	Euro €	VAT excluded IVA esclusa
Round canopy for 7 suspensions	Matte White - 9010 Bianco Opaco - 9010	Cluster	R04L07 1000	357,00	
Rosone circolare per 7 sospensioni	Matte Black - 9005 Nero Opaco - 9005		R04L07 2000	357,00	

CE IP20

9 Lights Round

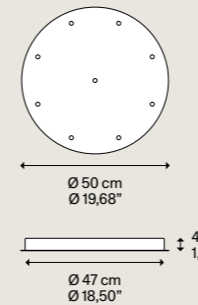

Net weight 5,84 kg / 12,87 lbs
Pack Colli 1

Description Descrizione	Metal structure Struttura in metallo	System Sistema	Code Codice	Euro €	VAT excluded IVA esclusa
Round canopy for 9 suspensions	Matte White - 9010 Bianco Opaco - 9010	Cluster	R04L09 1000	560,00	
Rosone circolare per 9 sospensioni	Matte Black - 9005 Nero Opaco - 9005		R04L09 2000	560,00	

CE IP20

14 Lights Round

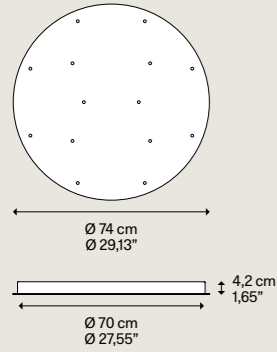

Net weight 14,14 kg / 31,17 lbs
Pack Colli 1

Description Descrizione	Metal structure Struttura in metallo	System Sistema	Code Codice	Euro €
Round canopy for 14 suspensions	Matte White - 9010 Bianco Opaco - 9010	Cluster	R04L14 1000	1060,00
Rosone circolare per 14 sospensioni	Matte Black - 9005 Nero Opaco - 9005		R04L14 2000	1060,00

VAT excluded IVA esclusa
CE IP20

24 Lights Round

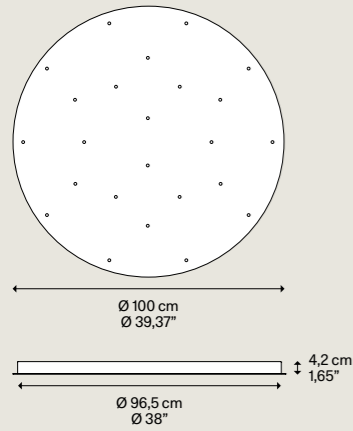

Net weight 23,50 kg / 51,80 lbs
Pack Colli 1

Description Descrizione	Metal structure Struttura in metallo	System Sistema	Code Codice	Euro €
Round canopy for 24 suspensions	Matte White - 9010 Bianco Opaco - 9010	Cluster	R04L24 1000	1826,00
Rosone circolare per 24 sospensioni	Matte Black - 9005 Nero Opaco - 9005		R04L24 2000	1826,00

VAT excluded IVA esclusa
CE IP20

36 Lights Round

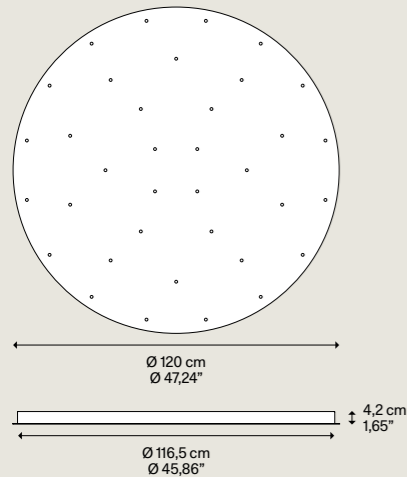

Net weight 32,70 kg / 72,09 lbs
Pack Colli 1

Description Descrizione	Metal structure Struttura in metallo	System Sistema	Code Codice	Euro €
Round canopy for 36 suspensions	Matte White - 9010 Bianco Opaco - 9010	Cluster	R04L36 1000	2244,00
Rosone circolare per 36 sospensioni	Matte Black - 9005 Nero Opaco - 9005		R04L36 2000	2244,00

VAT excluded IVA esclusa
CE IP20

7 Lights Rectangular

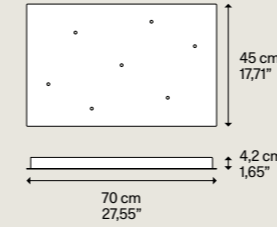

Net weight 9,89 kg / 21,80 lbs
Pack Colli 1

Description Descrizione	Metal structure Struttura in metallo	System Sistema	Code Codice	Euro €
Rectangular canopy for 7 suspensions	Matte White - 9010 Bianco Opaco - 9010	Cluster	R05L07 1000	560,00
Rosone rettangolare per 7 sospensioni	Matte Black - 9005 Nero Opaco - 9005		R05L07 2000	560,00

VAT excluded IVA esclusa
CE IP20

14 Lights Rectangular

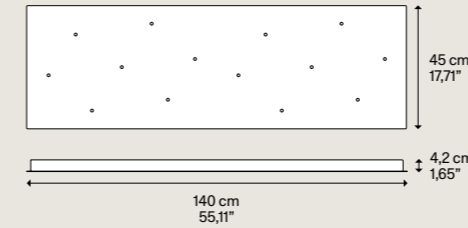

Net weight 17,10 kg / 37,80 lbs
Pack Colli 1

Description Descrizione	Metal structure Struttura in metallo	System Sistema	Code Codice	Euro €
Rectangular canopy for 14 suspensions	Matte White - 9010 Bianco Opaco - 9010	Cluster	R05L14 1000	1005,00
Rosone rettangolare per 14 sospensioni	Matte Black - 9005 Nero Opaco - 9005		R05L14 2000	1005,00

VAT excluded IVA esclusa
CE IP20

28 Lights Rectangular

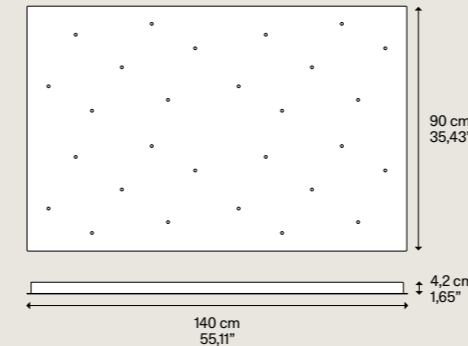

Net weight 31,10 kg / 68,56 lbs
Pack Colli 1

Description Descrizione	Metal structure Struttura in metallo	System Sistema	Code Codice	Euro €
Rectangular canopy for 28 suspensions	Matte White - 9010 Bianco Opaco - 9010	Cluster	R05L28 1000	1785,00
Rosone rettangolare per 28 sospensioni	Matte Black - 9005 Nero Opaco - 9005		R05L28 2000	1785,00

VAT excluded IVA esclusa
CE IP20

4 Lights Radial



Ø 16,5 cm
Ø 6,49"

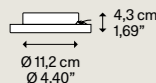

Net weight 0,35 kg
Peso netto 0,13 lbs
Pack Colli 1

VAT excluded IVA esclusa

Description Descrizione	Metal structure Struttura in metallo	System Sistema	Code Codice	Euro €
Radial canopy max 4 suspension Radial Swag Kit not included	● Matte White - 9010 Bianco Opaco - 9010	Radial	R10L04 1000	133,00
Rosone radiale max 4 sospensioni Radial Swag Kit non incluso	● Matte Black - 9005 Nero Opaco - 9005		R10L04 2000	133,00

CE IP20

12 Lights Radial



Ø 25 cm
Ø 9,84"

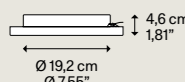

Net weight 1,05 kg
Peso netto 2,31 lbs
Pack Colli 1

VAT excluded IVA esclusa

Description Descrizione	Metal structure Struttura in metallo	System Sistema	Code Codice	Euro €
Radial canopy max 12 suspension Radial Swag Kit not included	● Matte White - 9010 Bianco Opaco - 9010	Radial	R10L12 1000	322,00
Rosone radiale max 12 sospensioni Radial Swag Kit non incluso	● Matte Black - 9005 Nero Opaco - 9005		R10L12 2000	322,00

CE IP20

28 Lights Radial

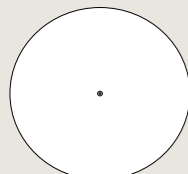

Ø 36 cm
Ø 14,17"

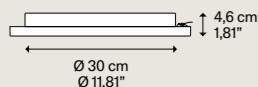

Net weight 3,35 kg
Peso netto 7,38 lbs
Pack Colli 1

VAT excluded IVA esclusa

Description Descrizione	Metal structure Struttura in metallo	System Sistema	Code Codice	Euro €
Radial canopy max 28 suspension Radial Swag Kit not included	● Matte White - 9010 Bianco Opaco - 9010	Radial	R10L28 1000	505,00
Rosone radiale max 28 sospensioni Radial Swag Kit non incluso	● Matte Black - 9005 Nero Opaco - 9005		R10L28 2000	505,00

CE IP20

Swag Kit for Radial Canopy



Ø 2 cm
Ø 0,78"



Net weight 0,02 kg
Peso netto 0,04 lbs
Pack Colli 1

Description Descrizione	Polycarbonate structure Struttura in policarbonato	System Sistema	Code Codice	Euro €
Wall and ceiling anchor for Radial System power cable /Max Ø 7 mm - 0,27" /Max capacity 5 kg - 11,02 lbs	● Clear Trasparente	Radial	999A4 00	22,00
Cilindro di decentramento per Sistema Radiale cavo elettrico /Max Ø 7 mm - 0,27" /Portata max 5 kg - 11,02 lbs				

VAT excluded IVA esclusa

CE

Short Lights Track

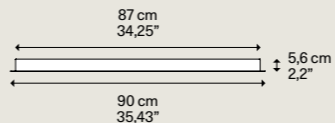
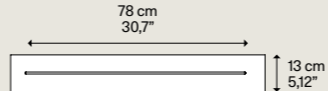

Net weight 7,33 kg
Peso netto 16,16 lbs
Pack Colli 1

VAT excluded IVA esclusa

Description Descrizione	Metal structure Struttura in metallo	System Sistema	Code Codice	Euro €
Multiple linear track standard version max 7 suspensions Binario lineare multiplo versione standard max 7 sospensioni	● Matte White - 9010 Bianco Opaco - 9010	Track	R08L07 1000	403,00
	● Matte Black - 9005 Nero Opaco - 9005		R08L07 2000	403,00

CE IP20

Long Lights Track

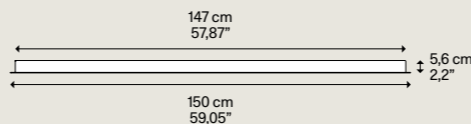
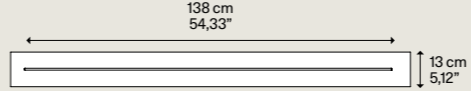

Net weight 11,85 kg
Peso netto 26,12 lbs
Pack Colli 1

VAT excluded IVA esclusa

Description Descrizione	Metal structure Struttura in metallo	System Sistema	Code Codice	Euro €
Multiple linear track standard version max 11 suspensions Binario lineare multiplo versione standard max 11 sospensioni	● Matte White - 9010 Bianco Opaco - 9010	Track	R08L11 1000	674,00
	● Matte Black - 9005 Nero Opaco - 9005		R08L11 2000	674,00

CE IP20

Suspension aligned, maximum quantity
Sospensione allineata, quantità massima



Staggered suspension, maximum quantity
Sospensione sfalsata, quantità massima



Short Lights Track		Long Lights Track		Short Lights Track		Long Lights Track	
Max 7	A-Tube	Max 11	A-Tube	Max 7	A-Tube	Max 11	A-Tube
Max 6	A-Tube Nano	Max 10	A-Tube Nano	Max 6	A-Tube Nano	Max 10	A-Tube Nano
Max 6	A-Tube Nano Duo	Max 10	A-Tube Nano Duo	Max 6	A-Tube Nano Duo	Max 10	A-Tube Nano Duo
Max 4	Cono di Luce small	Max 8	Cono di Luce small	Max 7	Cono di Luce small	Max 11	Cono di Luce small
Max 4	Cono di Luce large	Max 8	Cono di Luce large	Max 7	Cono di Luce large	Max 11	Cono di Luce large
Max 6	IVY I	Max 10	IVY I	Max 7	IVY I	Max 11	IVY I
Max 5	Jefferson	Max 8	Jefferson	Max 6	Jefferson	Max 10	Jefferson
Max 4	JIM cylinder	Max 8	JIM cylinder	Max 7	JIM cylinder	Max 11	JIM cylinder
Max 3	JIM cone	Max 5	JIM cone	Max 5	JIM cone	Max 9	JIM cone
Max 3	JIM bell	Max 5	JIM bell	Max 5	JIM bell	Max 9	JIM bell
Max 4	Kelly Cluster	Max 8	Kelly Cluster	Max 7	Kelly Cluster	Max 11	Kelly Cluster
Max 7	Nostalgia small	Max 11	Nostalgia small	Max 7	Nostalgia small	Max 11	Nostalgia small
Max 4	Nostalgia medium	Max 7	Nostalgia medium	Max 7	Nostalgia medium	Max 11	Nostalgia medium
Max 3	Nostalgia large	Max 5	Nostalgia large	Max 5	Nostalgia large	Max 9	Nostalgia large
Max 4	Oblò small	Max 7	Oblò small	Max 7	Oblò small	Max 13	Oblò small
Max 4	Oblò medium	Max 7	Oblò medium	Max 7	Oblò medium	Max 12	Oblò medium
Max 4	Oblò large	Max 6	Oblò large	Max 6	Oblò large	Max 11	Oblò large
Max 7	Rain	Max 11	Rain	Max 7	Rain	Max 11	Rain
Max 3	Random	Max 5	Random	Max 5	Random	Max 9	Random
Max 7	Random Solo 10	Max 11	Random Solo 10	Max 7	Random Solo 10	Max 11	Random Solo 10
Max 7	Random Solo 12	Max 11	Random Solo 12	Max 7	Random Solo 12	Max 11	Random Solo 12
Max 6	Random Solo 14	Max 10	Random Solo 14	Max 7	Random Solo 14	Max 11	Random Solo 14
Max 4	Random Solo 18	Max 8	Random Solo 18	Max 7	Random Solo 18	Max 11	Random Solo 18
Max 4	Random Solo 23	Max 6	Random Solo 23	Max 7	Random Solo 23	Max 11	Random Solo 23
Max 3	Random Solo 28	Max 6	Random Solo 28	Max 6	Random Solo 28	Max 10	Random Solo 28
Max 7	Spider	Max 11	Spider	Max 7	Spider	Max 11	Spider
Max 6	Volum 14	Max 10	Volum 14	Max 7	Volum 14	Max 11	Volum 14
Max 4	Volum 22	Max 7	Volum 22	Max 7	Volum 22	Max 11	Volum 22
Max 3	Volum 29	Max 5	Volum 29	Max 5	Volum 29	Max 9	Volum 29

Wall & Ceiling lamps

Wall lamps

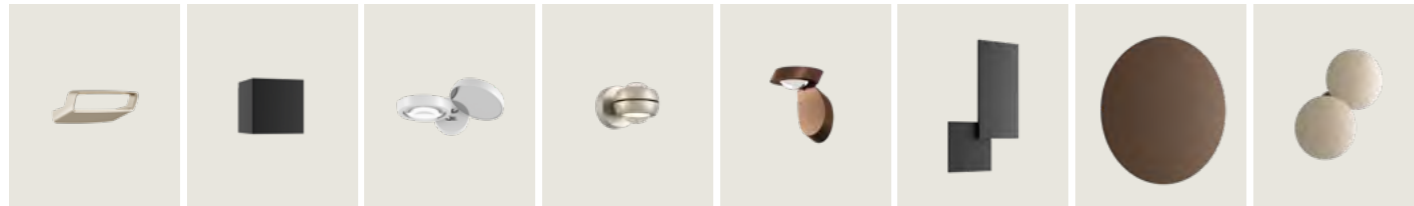

Aile P. 056 Laser P. 058 Nautilus P. 059, 060 Nautilus Mini P. 060 Pin-Up P. 061 Puzzle P. 063 Puzzle Mega P. 064-066 Puzzle Round P. 062



Shift P. 070 Volum P. 071-073

Ceiling lamps



A-Tube P. 053 A-Tube Nano Swing P. 054, 055 Bugia P. 056-058 Nautilus P. 059, 060 Nautilus Spot P. 061 Pin-Up P. 061 Puzzle P. 063 Puzzle Mega P. 064-066



Puzzle Round P. 062 Spider P. 067 Tidal P. 068, 069 Volum P. 071-073

CATEGORY CEILING LAMP

DESIGN Studio Italia Design, 2013

VAT excluded
IVA esclusa

A-Tube mini



Light source Sorgente luminosa

GU10 Par 16 1x 10 W W/L max 9 cm W/L max 3,54"

Bulb not included
Lampadina non inclusa

Metal structure Montatura in metallo

	Code Codice	Euro €
Matte White - 9010 Bianco Opaco - 9010	09631 1000	118,00
Matte Black - 9005 Nero Opaco - 9005	09631 2000	118,00
Coppery Bronze Bronzo Ramato	09631 3500	123,00

Net weight 0,20 kg
Peso netto 0,44 lbs Pack Colli 1

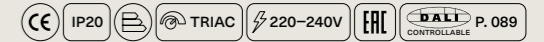

A-Tube small



Light source Sorgente luminosa

GU10 Par 16 1x 10 W W/L max 9 cm W/L max 3,54"

Bulb not included
Lampadina non inclusa

Metal structure Montatura in metallo

	Code Codice	Euro €
Matte White - 9010 Bianco Opaco - 9010	09632 1000	164,00
Matte Black - 9005 Nero Opaco - 9005	09632 2000	164,00
Coppery Bronze Bronzo Ramato	09632 3500	169,00

Net weight 0,80 kg
Peso netto 1,76 lbs Pack Colli 1

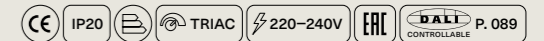

A-Tube medium



Light source Sorgente luminosa

GU10 Par 16 1x 10 W W/L max 9 cm W/L max 3,54"

Bulb not included
Lampadina non inclusa

Metal structure Montatura in metallo

	Code Codice	Euro €
Matte White - 9010 Bianco Opaco - 9010	09633 1000	240,00
Matte Black - 9005 Nero Opaco - 9005	09633 2000	240,00
Coppery Bronze Bronzo Ramato	09633 3500	255,00

Net weight 0,90 kg
Peso netto 1,98 lbs Pack Colli 1

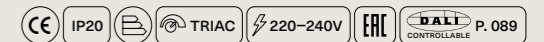

A-Tube large

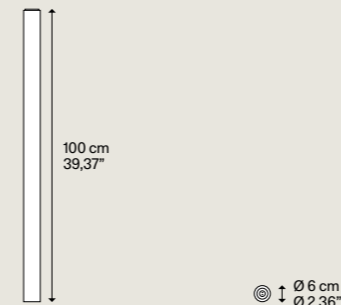

Light source Sorgente luminosa

GU10 Par 16 1x 10 W W/L max 9 cm W/L max 3,54"

Bulb not included
Lampadina non inclusa

Metal structure Montatura in metallo

	Code Codice	Euro €
Matte White - 9010 Bianco Opaco - 9010	09634 1000	337,00
Matte Black - 9005 Nero Opaco - 9005	09634 2000	337,00
Coppery Bronze Bronzo Ramato	09634 3500	358,00

Net weight 1,50 kg
Peso netto 3,31 lbs Pack Colli 1

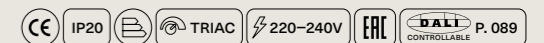

VAT excluded
IVA esclusa

A-Tube Nano Swing small

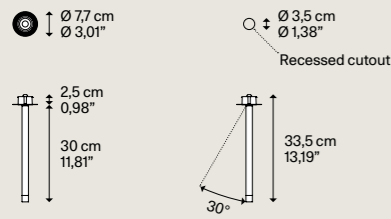

Metal structure Montatura in metallo	Methacrylate diffuser Diffusore in metacrilato	Code Codice	Code Codice	Euro €
Matte Black-9005 Nero Opaco-9005	Clear Trasparente	15832 2020	15832 2035	175,00
Chrome Cromo		15832 4020	15832 4035	195,00
Champagne Champagne		15832 4520	15832 4535	180,00
Gold Oro		15832 5020	15832 5035	200,00
Rose Gold Oro Rosa		15832 5520	15832 5535	200,00
Terra Terra		15832 6720	15832 6735	195,00

Light source Sorgente luminosa	Light source Sorgente luminosa
LED 2700 K 3 W 450 lm 350 mA CRI 90 MacAdam 3-Step	LED 3000 K 3 W 480 lm 350 mA CRI 90 MacAdam 3-Step
LED and driver included LED e driver inclusi	LED and driver included LED e driver inclusi

Net weight Peso netto	0,68 kg 1,49 lbs	Pack Colli	2	Energy class Classe energetica	D
--------------------------	---------------------	---------------	---	-----------------------------------	---

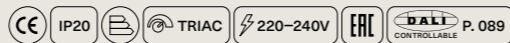

Metal structure Montatura in metallo	Methacrylate diffuser Diffusore in metacrilato	Code Codice	Code Codice	Euro €
Matte Black-9005 Nero Opaco-9005	Clear Trasparente	15833 2020	15833 2035	190,00
Chrome Cromo		15833 4020	15833 4035	215,00
Champagne Champagne		15833 4520	15833 4535	200,00
Gold Oro		15833 5020	15833 5035	225,00
Rose Gold Oro Rosa		15833 5520	15833 5535	225,00
Terra Terra		15833 6720	15833 6735	215,00

Light source Sorgente luminosa	Light source Sorgente luminosa
LED 2700 K 3 W 450 lm 350 mA CRI 90 MacAdam 3-Step	LED 3000 K 3 W 480 lm 350 mA CRI 90 MacAdam 3-Step
LED and driver included LED e driver inclusi	LED and driver included LED e driver inclusi

Net weight Peso netto	0,76 kg 1,67 lbs	Pack Colli	2	Energy class Classe energetica	D
--------------------------	---------------------	---------------	---	-----------------------------------	---

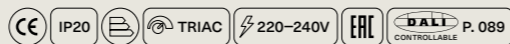

A-Tube Nano Swing large

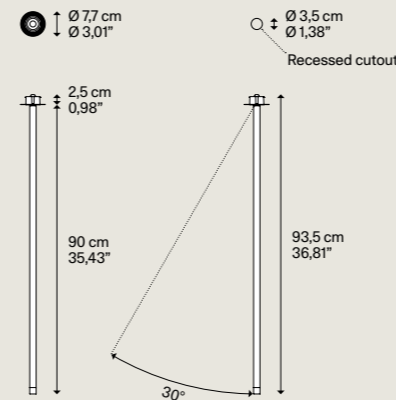

Metal structure Montatura in metallo	Methacrylate diffuser Diffusore in metacrilato	Code Codice	Code Codice	Euro €
Matte Black-9005 Nero Opaco-9005	Clear Trasparente	15834 2020	15834 2035	200,00
Chrome Cromo		15834 4020	15834 4035	235,00
Champagne Champagne		15834 4520	15834 4535	210,00
Gold Oro		15834 5020	15834 5035	245,00
Rose Gold Oro Rosa		15834 5520	15834 5535	245,00
Terra Terra		15834 6720	15834 6735	235,00

Light source Sorgente luminosa	Light source Sorgente luminosa
LED 2700 K 3 W 450 lm 350 mA CRI 90 MacAdam 3-Step	LED 3000 K 3 W 480 lm 350 mA CRI 90 MacAdam 3-Step
LED and driver included LED e driver inclusi	LED and driver included LED e driver inclusi

Net weight Peso netto	0,86 kg 1,89 lbs	Pack Colli	2	Energy class Classe energetica	D
--------------------------	---------------------	---------------	---	-----------------------------------	---

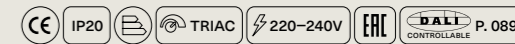

Adjustable light Luce orientabile

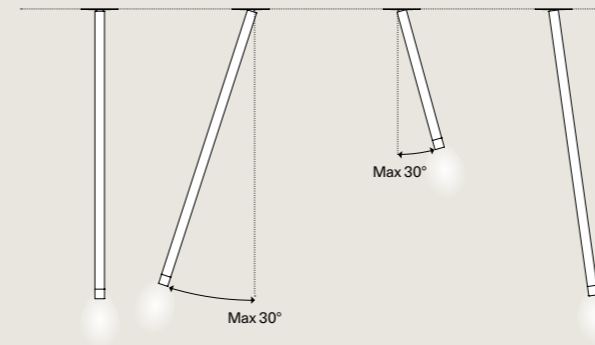

Aile

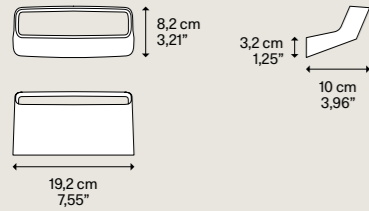

Metal structure Montatura in metallo	Code Codice	Code Codice	Euro €
Matte White – 9010 Bianco Opaco – 9010	17550 1027	17550 1030	169,00
Matte Black – 9005 Nero Opaco – 9005	17550 2027	17550 2030	169,00
Champagne Champagne	17550 4527	17550 4530	194,00
Lacquer Red Rosso Lacca	17550 6027	17550 6030	266,00

Light source
Sorgente luminosa

AC LED
2700 K
2x 8 W
1840 lm
220-240 V
CRI 92
MacAdam 3-Step

LED included
LED incluso

Light source
Sorgente luminosa

AC LED
3000 K
2x 8 W
1960 lm
220-240 V
CRI 92
MacAdam 3-Step

LED included
LED incluso

Net weight Peso netto	0,55 kg 1,21 lbs	Pack Colli	1	Energy class Classe energetica	E
--------------------------	---------------------	---------------	---	-----------------------------------	---

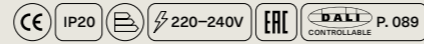

► LED sources with direct power supply to the AC line voltage – driver not required. ► LED con alimentazione diretta a tensione di rete – non necessita di driver.

Bugia Single

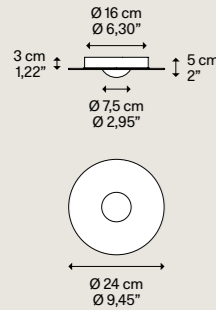

Metal structure Montatura in metallo	Methacrylate diffuser Diffusore in metacrilato	Code Codice	Code Codice	Euro €
Matte White – 9010 Bianco Opaco – 9010	Glossy White Bianco Lucido	16131 1227	16131 1230	250,00
	Glossy Black Nero Lucido	16131 2227	16131 2230	250,00
	Chrome Cromo	16131 4027	16131 4030	250,00
	Glossy Bronze Bronzo Lucido	16131 4627	16131 4630	250,00

Light source
Sorgente luminosa

AC LED
2700 K
15 W
1320 lm
220-240 V
CRI 90
MacAdam 3-Step

LED included
LED incluso

Light source
Sorgente luminosa

AC LED
3000 K
15 W
1440 lm
220-240 V
CRI 90
MacAdam 3-Step

LED included
LED incluso

Net weight Peso netto	0,80 kg 1,76 lbs	Pack Colli	2	Energy class Classe energetica	F
--------------------------	---------------------	---------------	---	-----------------------------------	---

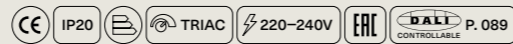

► LED sources with direct power supply to the AC line voltage – driver not required. Dimmable with phase cut dimmer. ► LED con alimentazione diretta a tensione di rete – non necessita di driver. Dimmerabile con varialuce a taglio di fase.

Bugia Double

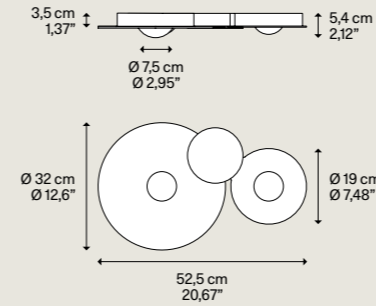

Metal structure Montatura in metallo	Methacrylate diffuser Diffusore in metacrilato	Code Codice	Code Codice	Euro €
Matte White – 9010 Bianco Opaco – 9010	Glossy White Bianco Lucido	16132 1227	16132 1230	444,00
	Glossy Black Nero Lucido	16132 2227	16132 2230	444,00
	Chrome Cromo	16132 4027	16132 4030	444,00
	Glossy Bronze Bronzo Lucido	16132 4627	16132 4630	444,00

Light source
Sorgente luminosa

AC LED
2700 K
2x 15 W
2640 lm
220-240 V
CRI 90
MacAdam 3-Step

LED included
LED incluso

Light source
Sorgente luminosa

AC LED
3000 K
2x 15 W
2880 lm
220-240 V
CRI 90
MacAdam 3-Step

LED included
LED incluso

Net weight Peso netto	2,05 kg 4,52 lbs	Pack Colli	2	Energy class Classe energetica	F
--------------------------	---------------------	---------------	---	-----------------------------------	---

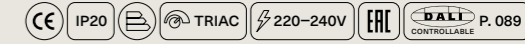

► LED sources with direct power supply to the AC line voltage – driver not required. Dimmable with phase cut dimmer. ► LED con alimentazione diretta a tensione di rete – non necessita di driver. Dimmerabile con varialuce a taglio di fase.

CATEGORY **CEILING LAMP**

Bugia Mega

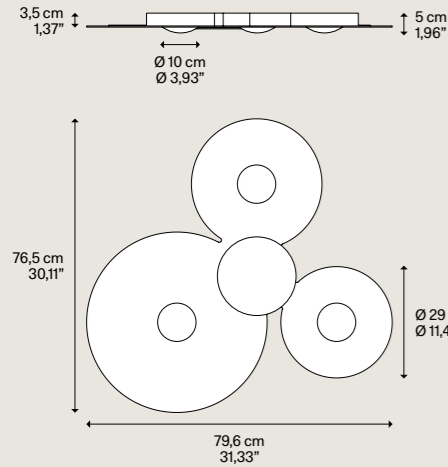

DESIGN Andrea Tosetto, 2020

Metal structure
Montatura in metallo

● Matte White - 9010
Bianco Opaco - 9010

Light source
Sorgente luminosa

AC LED
2700 K
3x 15 W
3960 lm
220-240 V
CRI 90
MacAdam 3-Step

LED included
LED incluso

Methacrylate diffuser
Diffusore in metacrilato

- Glossy White
Bianco Lucido
- Glossy Black
Nero Lucido
- Chrome
Cromo
- Glossy Bronze
Bronzo Lucido

Light source
Sorgente luminosa

AC LED
3000 K
3x 15 W
4320 lm
220-240 V
CRI 90
MacAdam 3-Step

LED included
LED incluso

Code Codice	Code Codice	Euro €
16134 1227	16134 1230	847,00
16134 2227	16134 2230	847,00
16134 4027	16134 4030	847,00
16134 4627	16134 4630	847,00

VAT excluded
IVA esclusa

Net weight 4,40 kg
Peso netto 9,70 lbs
Pack Colli 2
Energy class Classe energetica F

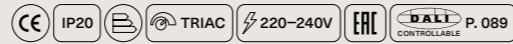

CATEGORY **WALL LAMP**

Laser

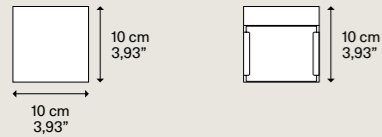

DESIGN Studio Italia Design, 2015

Metal structure
Montatura in metallo

- Matte White - 9010
Bianco Opaco - 9010
- Matte Black - 9005
Nero Opaco - 9005
- Champagne
Champagne

Light source
Sorgente luminosa

AC LED
2700 K
16 W
1750 lm
220-240 V
CRI 92
MacAdam 3-Step

LED included
LED incluso

Light source
Sorgente luminosa

AC LED
3000 K
16 W
1850 lm
220-240 V
CRI 92
MacAdam 3-Step

LED included
LED incluso

Code Codice	Code Codice	Euro €
03652 1027	03652 1030	174,00
03652 2027	03652 2030	174,00
03652 4527	03652 4530	184,00

VAT excluded
IVA esclusa

Net weight 0,60 kg
Peso netto 1,32 lbs
Pack Colli 1
Energy class Classe energetica E



► LED sources with direct power supply to the AC line voltage - driver not required. Dimmable with phase cut dimmer. ► LED con alimentazione diretta a tensione di rete - non necessita di driver. Dimmerabile con varialuce a taglio di fase.

CATEGORY **WALL LAMP**

Nautilus Dim-to-Warm

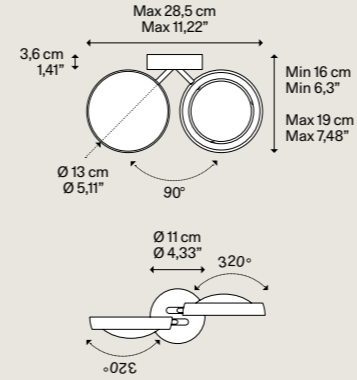

DESIGN Andrea Tosetto, 2024

Metal structure
Montatura in metallo

- Matte White - 9010
Bianco Opaco - 9010
- Matte Black - 9005
Nero Opaco - 9005
- Champagne
Champagne

Light source
Sorgente luminosa

LED
Dim-to-Warm
FROM 2200 K
TO 2700 K
2x 7 W
2000 lm
220-240 V
CRI 90
MacAdam 3-Step

LED and driver included
LED e driver inclusi

Dim-to-Warm

► 10% 2200 K 160 lm
► 30% 2400 K 520 lm
► 60% 2600 K 1200 lm
► 100% 2700 K 2000 lm

Net weight 1,80 kg
Peso netto 3,96 lbs
Pack Colli 1
Energy class Classe energetica E

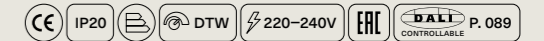

Adjustable light
Luce orientabile

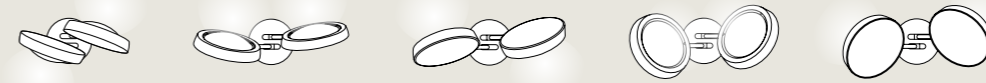

CATEGORY **WALL LAMP**

Nautilus

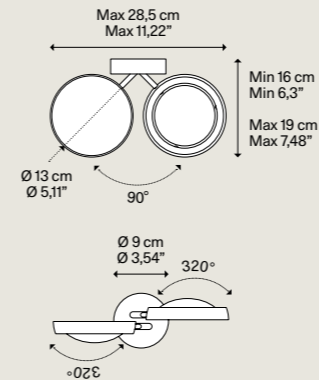

DESIGN Andrea Tosetto, 2017

Metal structure
Montatura in metallo

- Matte White - 9010
Bianco Opaco - 9010
- Matte Black - 9005
Nero Opaco - 9005
- Champagne
Champagne

Light source
Sorgente luminosa

AC LED
2700 K
2x 12 W
1990 lm
220-240 V
CRI 90
MacAdam 3-Step

LED included
LED incluso

Light source
Sorgente luminosa

AC LED
3000 K
2x 12 W
2170 lm
220-240 V
CRI 90
MacAdam 3-Step

LED included
LED incluso

Net weight 1,15 kg
Peso netto 2,54 lbs
Pack Colli 1
Energy class Classe energetica F

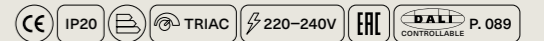

► LED sources with direct power supply to the AC line voltage - driver not required. Dimmable with phase cut dimmer. ► LED con alimentazione diretta a tensione di rete - non necessita di driver. Dimmerabile con varialuce a taglio di fase.

Adjustable light
Luce orientabile

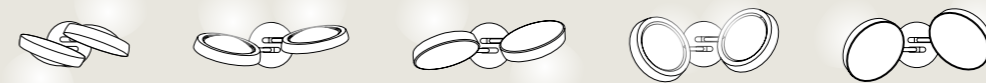

Nautilus Mini

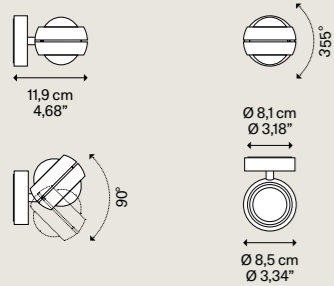

DESIGN Andrea Tosetto, 2017

VAT excluded
IVA esclusa

Metal structure Montatura in metallo	Code Codice	Code Codice	Euro €
Matte White – 9010 Bianco Opaco – 9010	16552 1027	16552 1030	255,00
Matte Black – 9005 Nero Opaco – 9005	16552 2027	16552 2030	255,00
Champagne Champagne	16552 4527	16552 4530	266,00

Light source
Sorgente luminosa

AC LED

2700	K
12	W
950	lm
220-240	V
CRI 90	

MacAdam 3-Step

LED included
LED incluso

Light source
Sorgente luminosa

AC LED

3000	K
12	W
1030	lm
220-240	V
CRI 90	

MacAdam 3-Step

LED included
LED incluso

Net weight Peso netto	0,75 kg 1,65 lbs	Pack Colli	1	Energy class Classe energetica	G
--------------------------	---------------------	---------------	---	-----------------------------------	---

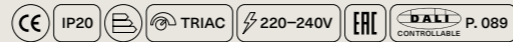

Adjustable light
Luce orientabile



Nautilus

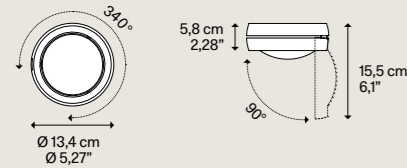

DESIGN Andrea Tosetto, 2017

VAT excluded
IVA esclusa

Metal structure Montatura in metallo	Code Codice	Code Codice	Euro €
Matte White – 9010 Bianco Opaco – 9010	16530 1027	16530 1030	255,00
Matte Black – 9005 Nero Opaco – 9005	16530 2027	16530 2030	255,00
Champagne Champagne	16530 4527	16530 4530	270,00

Light source
Sorgente luminosa

AC LED

2700	K
12	W
995	lm
220-240	V
CRI 90	

MacAdam 3-Step

LED included
LED incluso

Light source
Sorgente luminosa

AC LED

3000	K
12	W
1085	lm
220-240	V
CRI 90	

MacAdam 3-Step

LED included
LED incluso

Net weight Peso netto	1,10 kg 2,43 lbs	Pack Colli	1	Energy class Classe energetica	F
--------------------------	---------------------	---------------	---	-----------------------------------	---

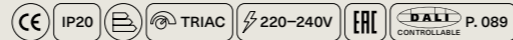

Adjustable light
Luce orientabile



► LED sources with direct power supply to the AC line voltage – driver not required. Dimmable with phase cut dimmer.

► LED con alimentazione diretta a tensione di rete – non necessita di driver. Dimmerabile con varialuce a taglio di fase.

Nautilus Spot

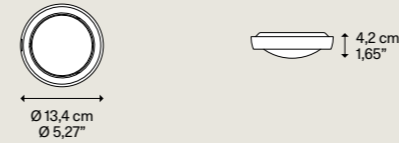

DESIGN Andrea Tosetto, 2020

VAT excluded
IVA esclusa

Metal structure Montatura in metallo	Code Codice	Code Codice	Euro €
Matte White – 9010 Bianco Opaco – 9010	16560 1027	16560 1030	189,00
Matte Black – 9005 Nero Opaco – 9005	16560 2027	16560 2030	189,00
Champagne Champagne	16560 4527	16560 4530	199,00

Light source
Sorgente luminosa

AC LED

2700	K
10	W
945	lm
220-240	V
CRI 90	

MacAdam 3-Step

LED included
LED incluso

Light source
Sorgente luminosa

AC LED

3000	K
10	W
950	lm
220-240	V
CRI 90	

MacAdam 3-Step

LED included
LED incluso

Net weight Peso netto	0,56 kg 1,23 lbs	Pack Colli	1	Energy class Classe energetica	F
--------------------------	---------------------	---------------	---	-----------------------------------	---

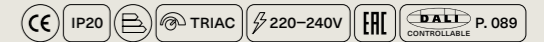

► LED sources with direct power supply to the AC line voltage – driver not required. Dimmable with phase cut dimmer.

► LED con alimentazione diretta a tensione di rete – non necessita di driver. Dimmerabile con varialuce a taglio di fase.

Pin-Up

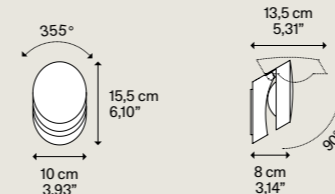

DESIGN Andrea Tosetto, 2015

VAT excluded
IVA esclusa

Metal structure Montatura in metallo	Code Codice	Code Codice	Euro €
Matte White – 9010 Bianco Opaco – 9010	15540 1027	15540 1030	235,00
Matte Black – 9005 Nero Opaco – 9005	15540 2027	15540 2030	235,00
Coppery Bronze Bronzo Ramato	15540 3527	15540 3530	240,00

Light source
Sorgente luminosa

AC LED

2700	K
8	W
920	lm
220-240	V
CRI 92	

MacAdam 3-Step

LED included
LED incluso

Light source
Sorgente luminosa

AC LED

3000	K
8	W
980	lm
220-240	V
CRI 92	

MacAdam 3-Step

LED included
LED incluso

Net weight Peso netto	1,15 kg 2,53 lbs	Pack Colli	1	Energy class Classe energetica	E
--------------------------	---------------------	---------------	---	-----------------------------------	---

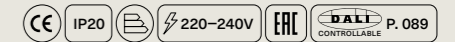

Adjustable light
Luce orientabile



► LED sources with direct power supply to the AC line voltage – driver not required.

► LED con alimentazione diretta a tensione di rete – non necessita di driver.

Puzzle Round single

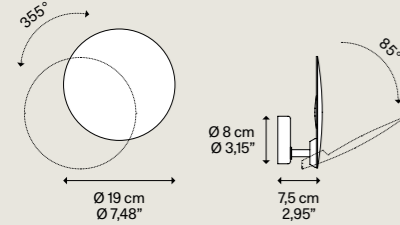

Net weight	0,60 kg	Pack	1	Energy class	E
Peso netto	1,32 lbs	Colli		Classe energetica	

Adjustable light
Luce orientabile



Puzzle Round double

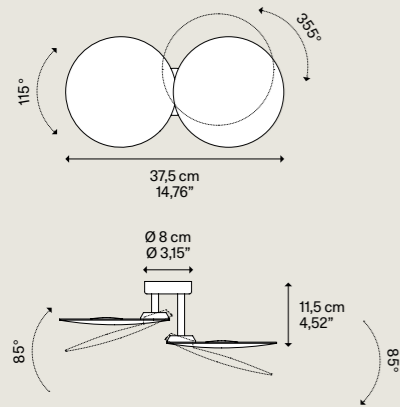

Net weight	1,10 kg	Pack	1	Energy class	E
Peso netto	2,43 lbs	Colli		Classe energetica	

Adjustable light
Luce orientabile



Metal structure
Montatura in metallo

	Code Codice	Code Codice	Euro €
Matte White – 9016 Bianco Opaco – 9016	15941 1027	15941 1030	220,00
Matte Black – 9005 Nero Opaco – 9005	15941 2027	15941 2030	220,00
Coppery Bronze Bronzo Ramato	15941 3527	15941 3530	230,00
Champagne Champagne	15941 4527	15941 4530	230,00

Light source
Sorgente luminosa

AC LED
2700 K
16 W
1750 lm
220-240 V
CRI 92
MacAdam 3-Step

LED included
LED incluso

Light source
Sorgente luminosa

AC LED
3000 K
16 W
1850 lm
220-240 V
CRI 92
MacAdam 3-Step

LED included
LED incluso

CE	IP20	TRIAC	220-240V	ERC	DALI CONTROLLABLE P. 089
----	------	-------	----------	-----	--------------------------

Puzzle single square

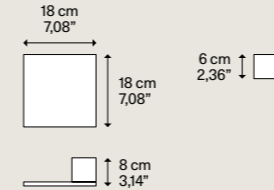

Net weight	1,16 kg	Pack	1	Energy class	E
Peso netto	2,56 lbs	Colli		Classe energetica	

Puzzle double square

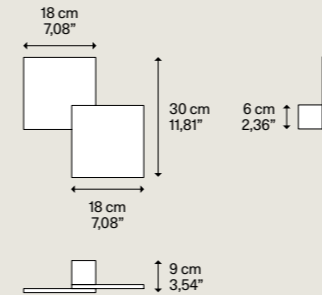

Net weight	2,00 kg	Pack	1	Energy class	E
Peso netto	4,41 lbs	Colli		Classe energetica	

Puzzle square & rectangle

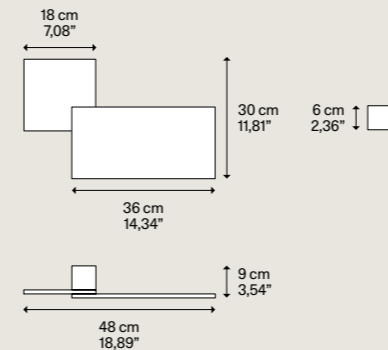

Net weight	2,91 kg	Pack	1	Energy class	E
Peso netto	6,42 lbs	Colli		Classe energetica	

► LED sources with direct power supply to the AC line voltage – driver not required. Dimmable with phase cut dimmer. ► Optional backplate available.

Metal structure
Montatura in metallo

	Code Codice	Code Codice	Euro €
Matte White – 9016 Bianco Opaco – 9016	14641 1027	14641 1030	204,00
Matte Black – 9005 Nero Opaco – 9005	14641 2027	14641 2030	204,00

Light source
Sorgente luminosa

AC LED
2700 K
16 W
1750 lm
220-240 V
CRI 92
MacAdam 3-Step

LED included
LED incluso

Light source
Sorgente luminosa

AC LED
3000 K
16 W
1850 lm
220-240 V
CRI 92
MacAdam 3-Step

LED included
LED incluso

CE	IP20	TRIAC	220-240V	ERC	DALI CONTROLLABLE P. 089
----	------	-------	----------	-----	--------------------------

Metal structure
Montatura in metallo

	Code Codice	Code Codice	Euro €
Matte White – 9016 Bianco Opaco – 9016	14642 1027	14642 1030	327,00
Matte Black – 9005 Nero Opaco – 9005	14642 2027	14642 2030	327,00

Light source
Sorgente luminosa

AC LED
2700 K
2x 16 W
3500 lm
220-240 V
CRI 92
MacAdam 3-Step

LED included
LED incluso

Light source
Sorgente luminosa

AC LED
3000 K
2x 16 W
3700 lm
220-240 V
CRI 92
MacAdam 3-Step

LED included
LED incluso

CE	IP20	TRIAC	220-240V	ERC	DALI CONTROLLABLE P. 089
----	------	-------	----------	-----	--------------------------

Metal structure
Montatura in metallo

	Code Codice	Code Codice	Euro €
Matte White – 9016 Bianco Opaco – 9016	14643 1027	14643 1030	388,00
Matte Black – 9005 Nero Opaco – 9005	14643 2027	14643 2030	388,00

Light source
Sorgente luminosa

AC LED
2700 K
2x 16 W
3500 lm
220-240 V
CRI 92
MacAdam 3-Step

LED included
LED incluso

Light source
Sorgente luminosa

AC LED
3000 K
2x 16 W
3700 lm
220-240 V
CRI 92
MacAdam 3-Step

LED included
LED incluso

CE	IP20	TRIAC	220-240V	ERC	DALI CONTROLLABLE P. 089
----	------	-------	----------	-----	--------------------------

► LED con alimentazione diretta a tensione di rete – non necessita di driver. Dimmerabile con varialuce a taglio di fase. ► Disponibile piastra a muro opzionale.

Puzzle Mega round small

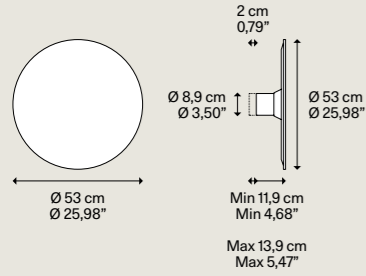

Metal structure Montatura in metallo

● Matte White - 9016
Bianco Opaco - 9016

Light source Sorgente luminosa

LED
Turnable White

25 W
2700 K → 4590 lm
3000 K → 4690 lm
550 mA
CRI 90
MacAdam 3-Step

LED and driver included
LED e driver inclusi

MDF diffuser Diffusore in MDF

● Matte White - 9016
Bianco Opaco - 9016

● Matte Black - 9005
Nero Opaco - 9005

● Taupe
Grigio Caldo

● Red
Rosso

Code Codice

16746 1023

16746 2023

16746 3923

16746 6023

VAT excluded
IVA esclusa

Euro €

592,00

663,00

663,00

663,00

Net weight 3,80 kg
Peso netto 8,38 lbs

Pack Colli 2

Energy class
Classe energetica C

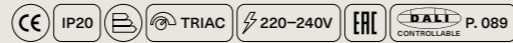

Puzzle Mega square small

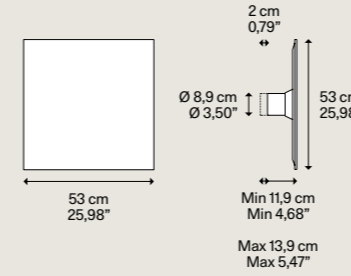

Metal structure Montatura in metallo

● Matte White - 9016
Bianco Opaco - 9016

Light source Sorgente luminosa

LED
Turnable White

25 W
2700 K → 4590 lm
3000 K → 4690 lm
550 mA
CRI 90
MacAdam 3-Step

LED and driver included
LED e driver inclusi

MDF diffuser Diffusore in MDF

● Matte White - 9016
Bianco Opaco - 9016

● Matte Black - 9005
Nero Opaco - 9005

● Taupe
Grigio Caldo

● Red
Rosso

Code Codice

16747 1023

16747 2023

16747 3923

16747 6023

VAT excluded
IVA esclusa

Euro €

592,00

663,00

663,00

663,00

Net weight 4,10 kg
Peso netto 9,04 lbs

Pack Colli 2

Energy class
Classe energetica C

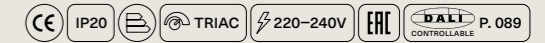

Puzzle Mega round large

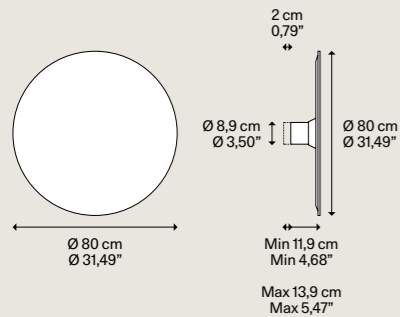

Metal structure Montatura in metallo

● Matte White - 9016
Bianco Opaco - 9016

Light source Sorgente luminosa

LED
Turnable White

33 W
2700 K → 5980 lm
3000 K → 6120 lm
700 mA
CRI 90
MacAdam 3-Step

LED and driver included
LED e driver inclusi

MDF diffuser Diffusore in MDF

● Matte White - 9016
Bianco Opaco - 9016

● Matte Black - 9005
Nero Opaco - 9005

● Taupe
Grigio Caldo

● Red
Rosso

Code Codice

16748 1023

16748 2023

16748 3923

16748 6023

VAT excluded
IVA esclusa

Euro €

1000,00

1102,00

1102,00

1102,00

Net weight 7,20 kg
Peso netto 15,87 lbs

Pack Colli 2

Energy class
Classe energetica C

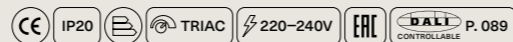

Puzzle Mega square large

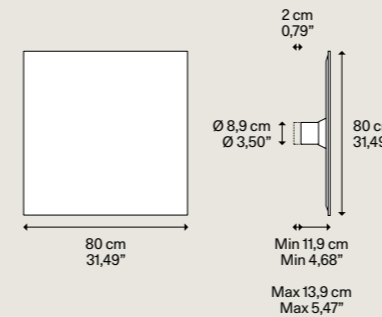

Metal structure Montatura in metallo

● Matte White - 9016
Bianco Opaco - 9016

Light source Sorgente luminosa

LED
Turnable White

33 W
2700 K → 5980 lm
3000 K → 6120 lm
700 mA
CRI 90
MacAdam 3-Step

LED and driver included
LED e driver inclusi

MDF diffuser Diffusore in MDF

● Matte White - 9016
Bianco Opaco - 9016

● Matte Black - 9005
Nero Opaco - 9005

● Taupe
Grigio Caldo

● Red
Rosso

Code Codice

16749 1023

16749 2023

16749 3923

16749 6023

VAT excluded
IVA esclusa

Euro €

1000,00

1102,00

1102,00

1102,00

Net weight 8,80 kg
Peso netto 19,40 lbs

Pack Colli 2

Energy class
Classe energetica C

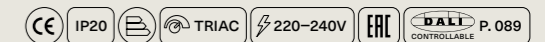

► LED sources with direct power supply to the AC line voltage – driver not required. Dimmable with phase cut dimmer. ► You can connect up to 4 Puzzle Mega to each fixture directly connected to the power supply. You can also connect up to 3 additional fixtures to each of those for maximum total of 36 fixtures on a single power outlet.

► LED con alimentazione diretta a tensione di rete – non necessita di driver. Dimmerabile con varialuce a taglio di fase. ► Ad ogni Puzzle Mega connessa al punto di alimentazione elettrica possono esserne collegate altre 4. Ad ognuna di queste possono esserne collegate fino ad altre 3 e così via. Le lampade totali collegabili su un singolo punto di alimentazione sono 36.

► LED sources with direct power supply to the AC line voltage – driver not required. Dimmable with phase cut dimmer. ► You can connect up to 4 Puzzle Mega to each fixture directly connected to the power supply. You can also connect up to 3 additional fixtures to each of those for maximum total of 36 fixtures on a single power outlet.

► LED con alimentazione diretta a tensione di rete – non necessita di driver. Dimmerabile con varialuce a taglio di fase. ► Ad ogni Puzzle Mega connessa al punto di alimentazione elettrica possono esserne collegate altre 4. Ad ognuna di queste possono esserne collegate fino ad altre 3 e così via. Le lampade totali collegabili su un singolo punto di alimentazione sono 36.

Puzzle Mega extension

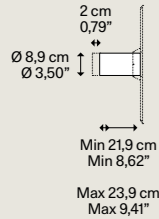

Description
Descrizione

Extension optional ► to be used to widen the light beam in case of ceiling installation

Estensione opzionale ► da utilizzare per ampliare il fascio luminoso in caso di installazione a soffitto

Metal structure
Montatura in metallo

- Matte White - 9016
- Bianco Opaco - 9016

Code
Codice

16799 A200

Euro €
67,00

Net weight 0,86 kg
Peso netto 1,86 lbs

Pack Colli 1



Puzzle Mega standard version
Puzzle Mega versione standard

Puzzle Mega extension optional version
Puzzle Mega versione estensione opzionale

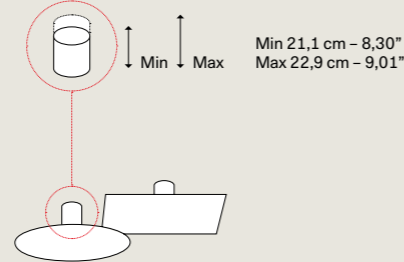
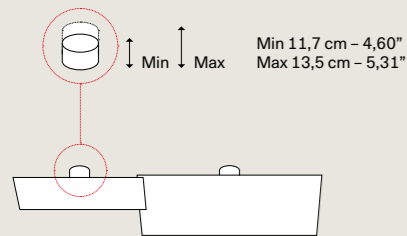

Accessory connector



Description
Descrizione

Connection ► to be used to connect the fixtures together in the compositions
Collegamento ► da utilizzare per collegare le lampade tra loro nelle composizioni

Code
Codice

16799 A100

Euro €
39,00

Net weight 0,10 kg
Peso netto 0,22 lbs

Pack Colli 1



Accessory connector
Accessorio di collegamento

Main power connection

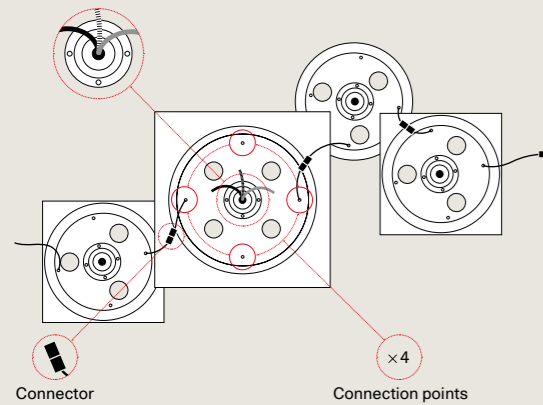

Spider

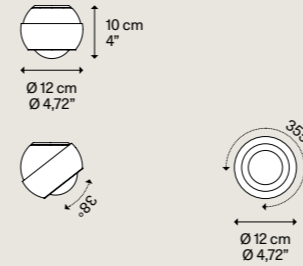

Metal structure
Montatura in metallo

- Chrome Cromo

Metal diffuser
Diffusore in metallo

- Matte White - 9010
Bianco Opaco - 9010
- Matte Black - 9005
Nero Opaco - 9005
- Extra Matte Champagne
Champagne Extra Opaco
- Terra Terra

Code
Codice

18340 1027
18340 2027
18340 4527
18340 6727

Code
Codice

18340 1030
18340 2030
18340 4530
18340 6730

Euro €
300,00
300,00
317,00
327,00

Adjustable light
Luce orientabile



Light source
Sorgente luminosa

AC LED
2700 K
10 W
920 lm
220-240 V
CRI 90
MacAdam 3-Step

LED included
LED incluso

Light source
Sorgente luminosa

AC LED
3000 K
10 W
980 lm
220-240 V
CRI 90
MacAdam 3-Step

LED included
LED incluso

Net weight 0,86 kg
Peso netto 1,89 lbs

Pack Colli 2

Energy class
Classe energetica F

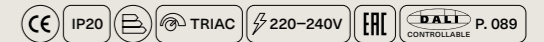

► LED sources with direct power supply to the AC line voltage - driver not required. Dimmable with phase cut dimmer.

► LED con alimentazione diretta a tensione di rete - non necessita di driver. Dimmerabile con varialuce a taglio di fase.

Tidal 45

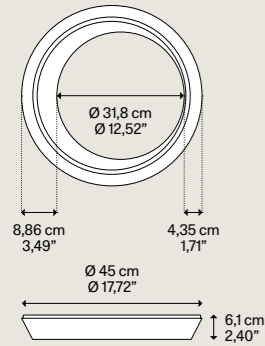

Net weight	2,80 kg	Pack	1	Energy class	C
Peso netto	6,17 lbs	Colli	1	Classe energetica	

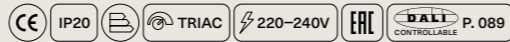

Metal structure Montatura in metallo	Code Codice	Code Codice	Euro €
Matte White - 9016 Bianco Opaco - 9016	19931 1027	19931 1030	498,00
Matte Black - 9005 Nero Opaco - 9005	19931 2027	19931 2030	498,00
Extra Matte Champagne Champagne Extra Opaco	19931 4527	19931 4530	524,00
Terra Terra	19931 6727	19931 6730	550,00

Light source Sorgente luminosa		Light source Sorgente luminosa	
A		B	
LED	2700 K	LED	3000 K
27	W	27	W
5040	lm	5292	lm
1100	mA	1100	mA
CRI 90		CRI 90	
MacAdam 3-Step		MacAdam 3-Step	
LED and driver included LED e driver inclusi		LED and driver included LED e driver inclusi	

Tidal 60

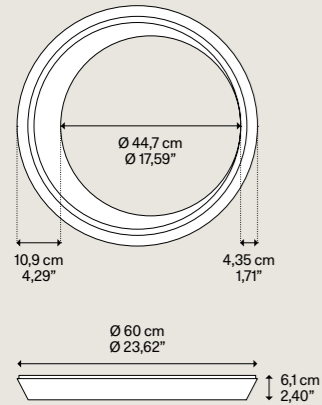

Net weight	3,90 kg	Pack	1	Energy class	C
Peso netto	8,60 lbs	Colli	1	Classe energetica	

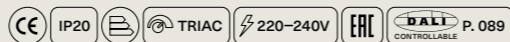

Metal structure Montatura in metallo	Code Codice	Code Codice	Euro €
Matte White - 9016 Bianco Opaco - 9016	19933 1027	19933 1030	682,00
Matte Black - 9005 Nero Opaco - 9005	19933 2027	19933 2030	682,00
Extra Matte Champagne Champagne Extra Opaco	19933 4527	19933 4530	712,00
Terra Terra	19933 6727	19933 6730	743,00

Light source Sorgente luminosa		Light source Sorgente luminosa	
A		B	
LED	2700 K	LED	3000 K
37	W	37	W
6975	lm	7320	lm
Direct light ↘	600 mA	Direct light ↘	600 mA
Indirect light ↘	350 mA	Indirect light ↘	350 mA
CRI 90		CRI 90	
MacAdam 3-Step		MacAdam 3-Step	
LED and driver included LED e driver inclusi		LED and driver included LED e driver inclusi	
Double switch Doppia accensione		Double switch Doppia accensione	
The driver, included, is supplied with an output voltage of 600 mA but can be adjusted during installation		The driver, included, is supplied with an output voltage of 600 mA but can be adjusted during installation	
Il driver, incluso, è fornito con una corrente di uscita impostata a 600 mA ma può essere regolato in installazione		Il driver, incluso, è fornito con una corrente di uscita impostata a 600 mA ma può essere regolato in installazione	
▶ 500 mA	40 W 6083 lm	▶ 500 mA	40 W 6385 lm
▶ 550 mA	44 W 6529 lm	▶ 550 mA	44 W 6853 lm

Tidal 75

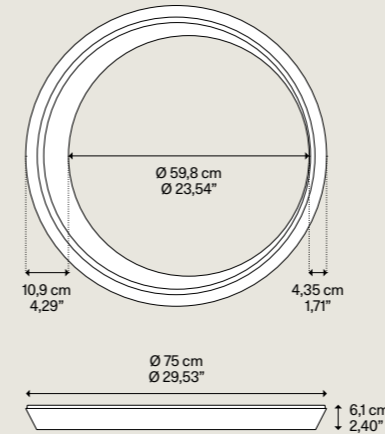

Net weight	5,38 kg	Pack	1	Energy class	C
Peso netto	11,86 lbs	Colli	1	Classe energetica	

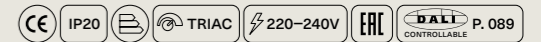

Metal structure Montatura in metallo	Code Codice	Code Codice	Euro €
Matte White - 9016 Bianco Opaco - 9016	19932 1027	19932 1030	880,00
Matte Black - 9005 Nero Opaco - 9005	19932 2027	19932 2030	880,00
Extra Matte Champagne Champagne Extra Opaco	19932 4527	19932 4530	930,00
Terra Terra	19932 6727	19932 6730	980,00

Light source Sorgente luminosa		Light source Sorgente luminosa	
A		B	
LED	2700 K	LED	3000 K
46	W	46	W
8589	lm	9072	lm
Direct light ↘	700 mA	Direct light ↘	700 mA
Indirect light ↘	550 mA	Indirect light ↘	550 mA
CRI 90		CRI 90	
MacAdam 3-Step		MacAdam 3-Step	
LED and driver included LED e driver inclusi		LED and driver included LED e driver inclusi	
Double switch Doppia accensione		Double switch Doppia accensione	
The driver, included, is supplied with an output voltage of 700 mA but can be adjusted during installation		The driver, included, is supplied with an output voltage of 700 mA but can be adjusted during installation	
Il driver, incluso, è fornito con una corrente di uscita impostata a 700 mA ma può essere regolato in installazione		Il driver, incluso, è fornito con una corrente di uscita impostata a 700 mA ma può essere regolato in installazione	
▶ 500 mA	39 W 6855 lm	▶ 500 mA	39 W 7236 lm
▶ 550 mA	43 W 7289 lm	▶ 550 mA	43 W 7695 lm
▶ 600 mA	47 W 7722 lm	▶ 600 mA	47 W 8154 lm

Light emission Emissione luminosa	Tidal 45			Tidal 60			Tidal 75		
A Direct light emission Emissione di luce diretta	2700 K	3600 lm	-	2700 K	4463 lm	500 mA	2700 K	4335 lm	500 mA
					4909 lm	550 mA		4769 lm	550 mA
					5355 lm	600 mA		5202 lm	600 mA
								6069 lm	700 mA
B Indirect light emission Emissione di luce indiretta	3000 K	3780 lm	-	3000 K	4675 lm	500 mA	3000 K	4590 lm	500 mA
					5143 lm	550 mA		5049 lm	550 mA
					5610 lm	600 mA		5508 lm	600 mA
								6426 lm	700 mA

Shift small

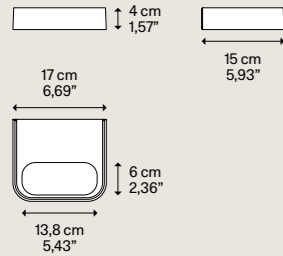

Light source Sorgente luminosa		Light source Sorgente luminosa	
A		B	
LED	K	LED	K
2700	W	3000	W
16	Im	16	Im
2495	mA	2580	mA
500		500	
CRI 90		CRI 90	
MacAdam 3-Step		MacAdam 3-Step	
LED and driver included LED e driver inclusi		LED and driver included LED e driver inclusi	

Net weight Peso netto	1,60 kg 3,52 lbs	Pack Colli	1	Energy class Classe energetica	D
--------------------------	---------------------	---------------	---	-----------------------------------	---

NEW LAMP

Shift large

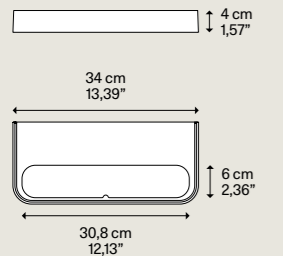

Light source Sorgente luminosa		Light source Sorgente luminosa	
A		B	
LED	K	LED	K
2700	W	3000	W
32,5	Im	32,5	Im
5085	mA	5255	mA
700		700	
CRI 90		CRI 90	
MacAdam 3-Step		MacAdam 3-Step	
LED and driver included LED e driver inclusi		LED and driver included LED e driver inclusi	

Net weight Peso netto	3,00 kg 6,61 lbs	Pack Colli	1	Energy class Classe energetica	D
--------------------------	---------------------	---------------	---	-----------------------------------	---

The light emission angle Angolo di emissione della luce

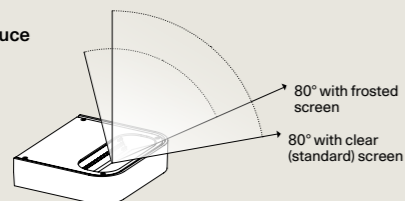

Metal structure Montatura in metallo	Code Codice	Code Codice	VAT excluded IVA esclusa
Matte White - 9010 Bianco Opaco - 9010	21551 1027	21551 1030	180,00
Matte Black - 9005 Nero Opaco - 9005	21551 2027	21551 2030	180,00
Extra Matte Champagne Champagne Extra Opaco	21551 4527	21551 4530	190,00
Natural Brown NSCS8005Y50R NEW Testa di Moro NSCS8005Y50R	21551 6927	21551 6930	185,00

Metal structure Montatura in metallo	Code Codice	Code Codice	VAT excluded IVA esclusa
Matte White - 9010 Bianco Opaco - 9010	21553 1027	21553 1030	240,00
Matte Black - 9005 Nero Opaco - 9005	21553 2027	21553 2030	240,00
Extra Matte Champagne Champagne Extra Opaco	21553 4527	21553 4530	250,00
Natural Brown NSCS8005Y50R NEW Testa di Moro NSCS8005Y50R	21553 6927	21553 6930	245,00

CE	IP20	TRIAC	DALI	220-240V	⏚
----	------	-------	------	----------	---

Metal structure Montatura in metallo	Code Codice	Code Codice	VAT excluded IVA esclusa
Matte White - 9010 Bianco Opaco - 9010	21552 1027	21552 1030	250,00
Matte Black - 9005 Nero Opaco - 9005	21552 2027	21552 2030	250,00
Extra Matte Champagne Champagne Extra Opaco	21552 4527	21552 4530	265,00
Natural Brown NSCS8005Y50R NEW Testa di Moro NSCS8005Y50R	21552 6927	21552 6930	260,00

Metal structure Montatura in metallo	Code Codice	Code Codice	VAT excluded IVA esclusa
Matte White - 9010 Bianco Opaco - 9010	21554 1027	21554 1030	370,00
Matte Black - 9005 Nero Opaco - 9005	21554 2027	21554 2030	370,00
Extra Matte Champagne Champagne Extra Opaco	21554 4527	21554 4530	385,00
Natural Brown NSCS8005Y50R NEW Testa di Moro NSCS8005Y50R	21554 6927	21554 6930	380,00

CE	IP20	TRIAC	DALI	220-240V	⏚
----	------	-------	------	----------	---

Volum mirror 14

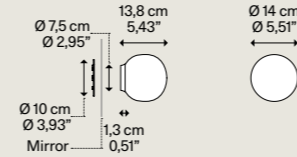

Net weight Peso netto	0,74 kg 1,63 lbs	Pack Colli	2
--------------------------	---------------------	---------------	---

Volum mirror 22

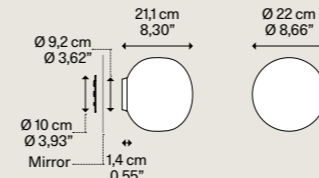

Net weight Peso netto	1,15 kg 2,53 lbs	Pack Colli	2
--------------------------	---------------------	---------------	---

Volum mirror 29

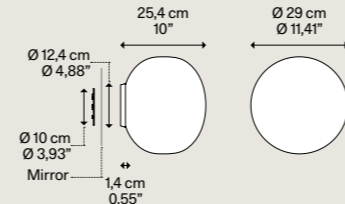

Net weight Peso netto	2,16 kg 4,76 lbs	Pack Colli	2
--------------------------	---------------------	---------------	---

Silicone structure Struttura in silicone	Blown glass diffuser Diffusore in vetro soffiato	Code Codice	VAT excluded IVA esclusa
Translucent Traslucido	Glossy White Bianco Lucido	18741 120S	210,00

**Light source
Sorgente luminosa**

E14 LED T18 Ø max 5 cm
1x 5 W Ø max 1,96"
(max 10 W) W/L max 9 cm
 W/L max 3,54"

Bulb not included
Lampadina non inclusa

CE	IP54	TRIAC	220-240V	ERC	DALI CONTROLLABLE P. 089
----	------	-------	----------	-----	--------------------------

Silicone structure Struttura in silicone	Blown glass diffuser Diffusore in vetro soffiato	Code Codice	VAT excluded IVA esclusa
Translucent Traslucido	Glossy White Bianco Lucido	18742 120S	307,00

**Light source
Sorgente luminosa**

E27 LED T28 Ø max 5 cm
1x 10 W Ø max 1,96"
(max 25 W) W/L max 12,5 cm
 W/L max 4,92"

Bulb not included
Lampadina non inclusa

CE	IP54	TRIAC	220-240V	ERC	DALI CONTROLLABLE P. 089
----	------	-------	----------	-----	--------------------------

Silicone structure Struttura in silicone	Blown glass diffuser Diffusore in vetro soffiato	Code Codice	VAT excluded IVA esclusa
Translucent Traslucido	Glossy White Bianco Lucido	18743 120S	373,00

**Light source
Sorgente luminosa**

E27 LED T35 Ø max 8,5 cm
1x 13 W Ø max 3,34"
(max 25 W)

Bulb not included
Lampadina non inclusa

CE	IP54	TRIAC	220-240V	ERC	DALI CONTROLLABLE P. 089
----	------	-------	----------	-----	--------------------------

SUSPENSION LAMP
CLUSTER SUSPENSION LAMP
CANOPY
WALL & CEILING LAMP
FLOOR & TABLE LAMP
ACCESSORY

CATEGORY WALL LAMP

DESIGN Snøhetta, 2023

VAT excluded
IVA esclusa

Volum mirror 42

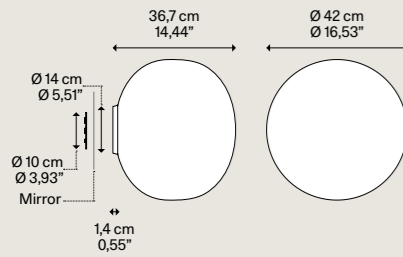

Net weight 3,39 kg
Peso netto 7,47 lbs
Pack Colli 2

Silicone structure
Struttura in silicone

Translucent
Traslucido

Blown glass diffuser
Diffusore in vetro soffiato

Glossy White
Bianco Lucido

Code
Codice

18744 120S

Euro €

541,00

Light source
Sorgente luminosa

E27 LED T35 1x 21 W (max 25 W)
Ø max 8,5 cm
Ø max 3,34"

Bulb not included
Lampadina non inclusa

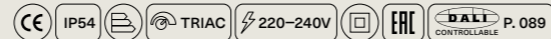

Application
Applicazione

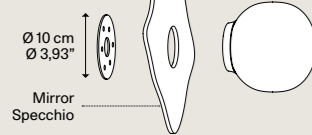

CATEGORY WALL LAMP CEILING LAMP

DESIGN Snøhetta, 2023

VAT excluded
IVA esclusa

Volum 14

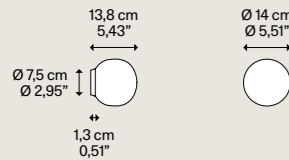

Net weight 0,74 kg
Peso netto 1,63 lbs
Pack Colli 2

Silicone structure
Struttura in silicone

Translucent
Traslucido

Blown glass diffuser
Diffusore in vetro soffiato

Glossy White
Bianco Lucido

Code
Codice

18741 1200

Euro €

169,00

Light source
Sorgente luminosa

E14 LED T18 1x 5 W (max 10 W)
Ø max 5 cm
Ø max 1,96"
W/L max 9 cm
W/L max 3,54"

Bulb not included
Lampadina non inclusa

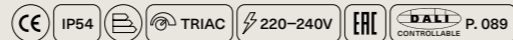

Volum 22

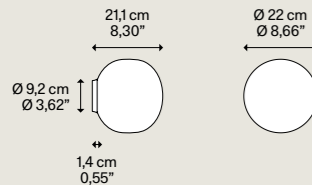

Net weight 1,15 kg
Peso netto 2,53 lbs
Pack Colli 2

Silicone structure
Struttura in silicone

Translucent
Traslucido

Blown glass diffuser
Diffusore in vetro soffiato

Glossy White
Bianco Lucido

Code
Codice

18742 1200

Euro €

266,00

Light source
Sorgente luminosa

E27 LED T28 1x 10 W (max 25 W)
Ø max 5 cm
Ø max 1,96"
W/L max 12,5 cm
W/L max 4,92"

Bulb not included
Lampadina non inclusa

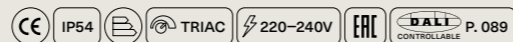

CATEGORY WALL LAMP CEILING LAMP

DESIGN Snøhetta, 2023

VAT excluded
IVA esclusa

Volum 29

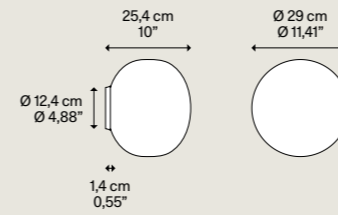

Net weight 2,16 kg
Peso netto 4,76 lbs
Pack Colli 2

Silicone structure
Struttura in silicone

Translucent
Traslucido

Blown glass diffuser
Diffusore in vetro soffiato

Glossy White
Bianco Lucido

Code
Codice

18743 1200

Euro €

332,00

Light source
Sorgente luminosa

E27 LED T35 1x 13 W (max 25 W)
Ø max 8,5 cm
Ø max 3,34"

Bulb not included
Lampadina non inclusa

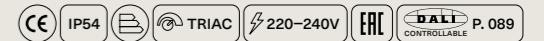

Volum 42

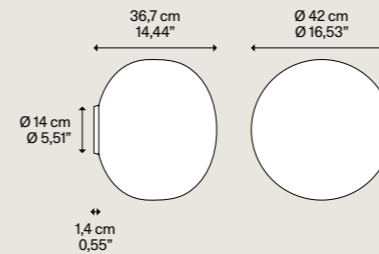

Net weight 3,39 kg
Peso netto 7,47 lbs
Pack Colli 2

Silicone structure
Struttura in silicone

Translucent
Traslucido

Blown glass diffuser
Diffusore in vetro soffiato

Glossy White
Bianco Lucido

Code
Codice

18744 1200

VAT excluded
IVA esclusa

Euro €

500,00

Light source
Sorgente luminosa

E27 LED T35 1x 21 W (max 25 W)
Ø max 8,5 cm
Ø max 3,34"

Bulb not included
Lampadina non inclusa

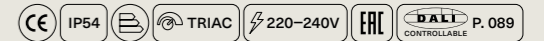

Light source
Sorgente luminosa

E14 LED T18 5 W
2700 K
500 lm
CRI 90
MacAdam 3-Step

E27 LED T28 10 W
2700 K
1000 lm
CRI 90
MacAdam 3-Step

E27 LED T35 13 W
2700 K
1500 lm
CRI 90
MacAdam 3-Step

E27 LED T35 21 W
2700 K
2010 lm
CRI 90
MacAdam 3-Step

Bulb dimension
Dimensione lampadina

Ø 1,8 cm
Ø 0,70"

W/L 6,1 cm
W/L 2,40"

Ø 2,8 cm
Ø 1,10"

Ø 3,5 cm
Ø 1,37"

Lamp
Lampada

Volum 14
P. 071, 072

Volum 22
P. 071, 072

Volum 29
P. 071, 073

Volum 42
P. 072, 073

Pack
Colli

1

1

1

1

Code
Codice

LAM-0017

LAM-0014

LAM-0015

LAM-0016

VAT excluded
IVA esclusa

Euro €

24,00

29,00

39,00

46,00

Dimmable bulbs / Lampadine dimmerabili

Floor & Table lamps

Floor lamps

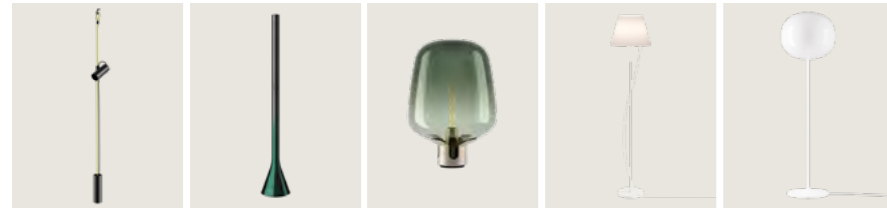

Cima P. 075 Croma P. 076 Flar P. 077 Hover P. 078 Volum P. 082-083

Table lamps

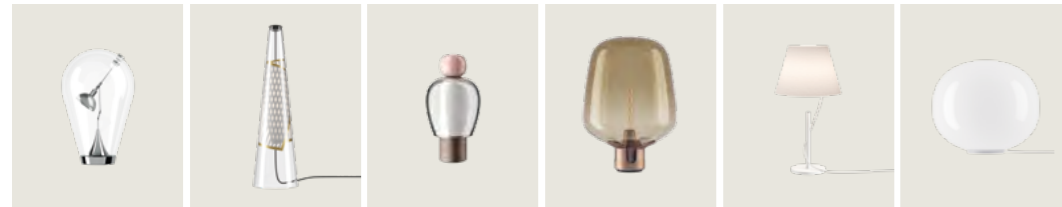

Blow P. 079 Cono di Luce P. 079 Easy Peasy P. 080 Flar P. 077 Hover P. 078 Volum P. 081

CATEGORY **SUSPENSION LAMP** **FLOOR LAMP**

Cima

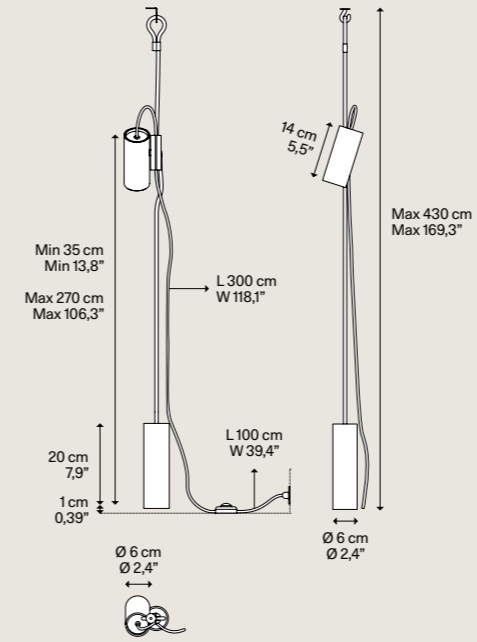

DESIGN Marco Dessì, 2021

VAT excluded
IVA esclusa

Metal structure Montatura in metallo	Rope Corda	Code Codice	Euro €
● Matte Black Nero Opaco	● Silver Argento	17371 4100	304,00
	● Gold Oro	17371 5000	304,00
	● Yellow Giallo	17371 5100	304,00

VAT excluded
IVA esclusa

Description Descrizione	Metal structure Montatura in metallo	Code Codice	Euro €
Additional kit (max 1 additional kit)	● Matte Black Nero Opaco	17371K 2000	199,00

Light source Sorgente luminosa

GU10 Par 16 LED 1 × 10 W
W/L max 9 cm
W/L max 3,54"

Bulb and dimmer not included
Lampadina e dimmer non inclusi

Net weight 1,75 kg
Peso netto 3,86 lbs Pack 1
Colli 1



Adjustable light Luce orientabile

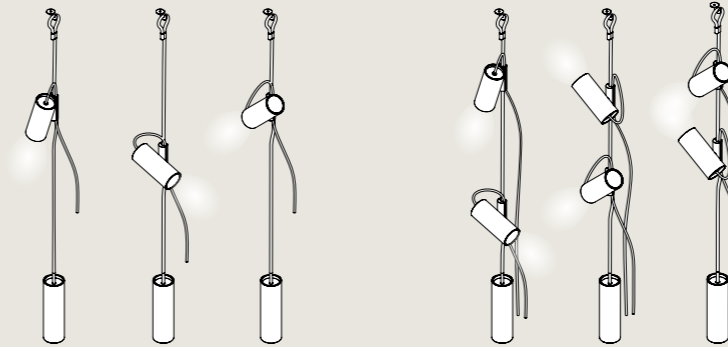

SUSPENSION LAMP
CLUSTER SUSPENSION LAMP
CANOPY
WALL & CEILING LAMP
FLOOR & TABLE LAMP
ACCESSORY

Croma

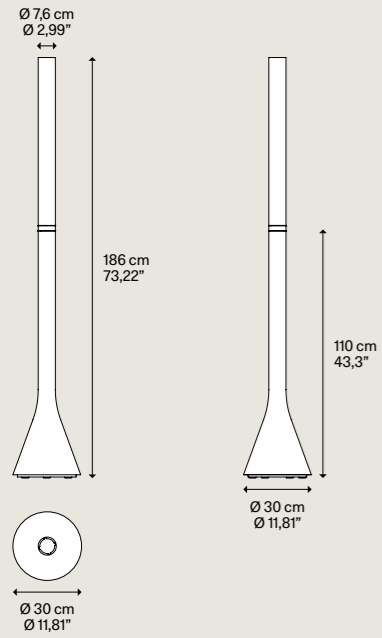

Net weight	15,00 kg	Pack	1	Energy class	E
Peso netto	33,07 lbs	Colli		Classe energetica	

Metal structure Montatura in metallo	Code Codice	Euro €
Matte White - 9010* Bianco Opaco - 9010*	17270 1000	1580,00
Matte Black - 9005 Nero Opaco - 9005	17270 2000	1580,00
Bronze Bronzo	17270 3400	2295,00
Green* Verde*	17270 7000	2295,00

Light source
Sorgente luminosa

LED
Dim-to-Warm
FROM 2200 K
TO 3200 K
42 W
5600 lm
220-240 V
CRI 90
MacAdam 3-Step

Dim-to-Warm		
► 20%	2200 K	1400 lm
► 40%	2600 K	2400 lm
► 60%	2850 K	3550 lm
► 80%	3000 K	4600 lm
► 100%	3200 K	5600 lm

LED, driver and Dim-to-Warm dimmer included
LED, driver e Dim-to-Warm dimmer inclusi



Flar medium

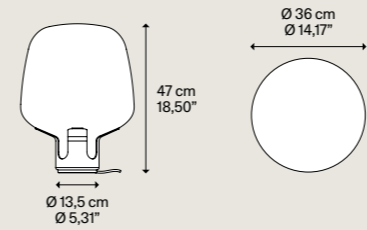

Net weight	6,77 kg	Pack	2
Peso netto	14,92 lbs	Colli	

Metal structure Montatura in metallo	Blown glass diffuser Diffusore in vetro soffiato	Code Codice	Euro €
Champagne Champagne	Honey Miele	19182 6800	908,00
Champagne Champagne	Turquoise Turchese	19182 8600	908,00
Terra Terra	Honey Miele	19183 6800	1030,00
Terra Terra	Turquoise Turchese	19183 8600	1030,00

Light source
Sorgente luminosa

E27 T30 W/L max 22,5 cm
Tubular LED W/L max 8,85"
1 x 6 W (max 25 W)

Bulb not included
Dimmer on the cord
included

Lampadina non inclusa
Dimmer nel filo incluso



Flar large

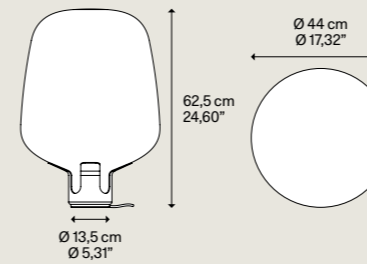

Net weight	9,89 kg	Pack	2
Peso netto	21,80 lbs	Colli	

Metal structure Montatura in metallo	Blown glass diffuser Diffusore in vetro soffiato	Code Codice	Euro €
Champagne Champagne	Honey Miele	19184 6800	1260,00
Champagne Champagne	Turquoise Turchese	19184 8600	1260,00
Terra Terra	Honey Miele	19185 6800	1382,00
Terra Terra	Turquoise Turchese	19185 8600	1382,00

Light source
Sorgente luminosa

E27 T30 W/L max 30 cm
Tubular LED W/L max 11,81"
1 x 7 W (max 25 W)

Bulb not included
Dimmer on the cord
included

Lampadina non inclusa
Dimmer nel filo incluso



CATEGORY FLOOR LAMP

Hover

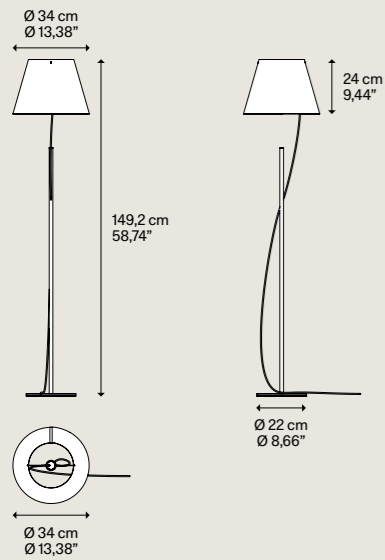

Net weight 3,86 kg / 8,51 lbs
 Pack Colli 2
 Energy class Classe energetica C

DESIGN YOY, 2022

Metal structure
 Montatura in metallo

Matte White
 Bianco Opaco

Paper diffuser
 Diffusore in carta

Matte White
 Bianco Opaco

Code
 Codice

18471 1027

VAT excluded
 IVA esclusa

Euro €

495,00

Light source
 Sorgente luminosa

LED
 2700 K
 6,5 W
 1000 lm
 5 V
 2 A
 CRI 90
 MacAdam 3-Step

LED, driver and touch dimmer included
 LED, driver e touch dimmer inclusi

USB adaptor included
 Adattatore USB incluso

CE IP20 E 5V EAC

CATEGORY TABLE LAMP

Hover

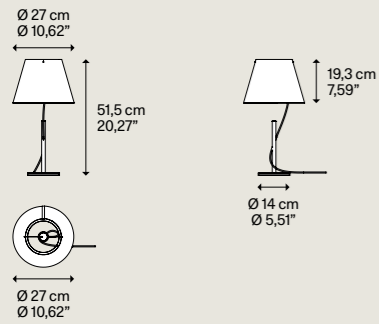

Net weight 1,68 kg / 3,70 lbs
 Pack Colli 2
 Energy class Classe energetica C

DESIGN YOY, 2022

Metal structure
 Montatura in metallo

Matte White
 Bianco Opaco

Paper diffuser
 Diffusore in carta

Matte White
 Bianco Opaco

Code
 Codice

18480 1027

VAT excluded
 IVA esclusa

Euro €

403,00

Light source
 Sorgente luminosa

LED
 2700 K
 6,5 W
 1000 lm
 5 V
 2 A
 CRI 90
 MacAdam 3-Step

LED, driver and touch dimmer included
 LED, driver e touch dimmer inclusi

USB adaptor included
 Adattatore USB incluso

CE IP20 E 5V EAC

Touch dimmer



CATEGORY TABLE LAMP

Blow

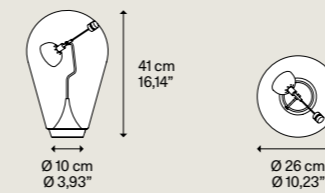

Net weight 4,00 kg / 8,82 lbs
 Pack Colli 1
 Energy class Classe energetica C

DESIGN Pio & Tito Toso, 2005

Metal structure
 Montatura in metallo

Chrome
 Cromo

Blown glass diffuser
 Diffusore in vetro soffiato

Clear
 Trasparente

Code
 Codice

00880 27

VAT excluded
 IVA esclusa

Euro €

1070,00

Light source
 Sorgente luminosa

LED
 2700 K
 4,5 W
 500 lm
 500 mA
 CRI 90
 MacAdam 3-Step

LED and driver included
 LED e driver inclusi

CE IP20 E TRIAC 220-240V EAC

Adjustable light
 Luce orientabile

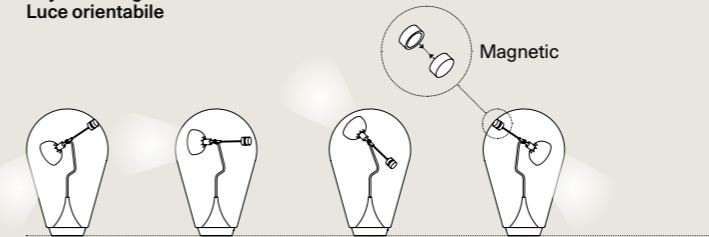

CATEGORY TABLE LAMP

Cono di Luce

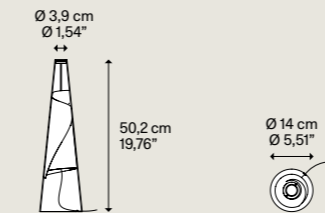

Net weight 0,91 kg / 2,00 lbs
 Pack Colli 2
 Energy class Classe energetica B

DESIGN Ron Arad, 2023

Outside blown glass diffuser
 Diffusore esterno in vetro soffiato

Clear
 Trasparente

Inside PCB diffuser
 Diffusore interno in PCB

- Grey / Grigio
- Gold / Oro
- Red / Rosso

Code
 Codice

21080 3227

VAT excluded
 IVA esclusa

Euro €

530,00

21080 5027

581,00

21080 6027

530,00

Light source
 Sorgente luminosa

LED
 2700 K
 7,5 W
 1307 lm
 5 V - 1,5 A
 CRI 90
 MacAdam 3-Step

LED and driver included
 LED e driver inclusi

CE IP20 E 5V-1,5A EAC

Easy Peasy

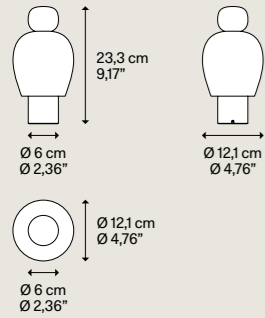

Light source Sorgente luminosa	Battery charging time Tempo di ricarica
LED Dim-to-Warm FROM 2200 K TO 2700 K 5 W 380 lm 2000 mA Battery CRI 90 MacAdam 3-Step	Power supply 1A ▶ 180 min Battery life Durata batteria Full power 100% ▶ 6h Half power 50% ▶ 10h Min power 10% ▶ 19h
LED and battery included LED e batteria inclusi	

Net weight 0,85 kg / 1,87 lbs | Pack Colli 1 | Energy class Classe energetica D

Flamingo

Technopolymer knob Pomolo in tecnopolimero	Blown glass shade Cappello in vetro soffiato	Metal base Base in metallo	Code Codice	Euro €
Pink Rosa	Grey Grigio	Brushed Bronze Bronzo Spazzolato	17081 6226	266,00

Lagoon

Technopolymer knob Pomolo in tecnopolimero	Blown glass shade Cappello in vetro soffiato	Metal base Base in metallo	Code Codice	Euro €
Turquoise Turchese	Honey Miele	Brushed Gold Oro Spazzolato	17081 8126	266,00

VAT excluded
IVA esclusa

CE IP20 DTW EAC

VAT excluded
IVA esclusa

Easy Peasy

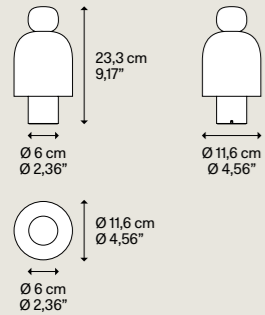

Light source Sorgente luminosa	Battery charging time Tempo di ricarica
LED Dim-to-Warm FROM 2200 K TO 2700 K 5 W 380 lm 2000 mA Battery CRI 90 MacAdam 3-Step	Power supply 1A ▶ 180 min Battery life Durata batteria Full power 100% ▶ 6h Half power 50% ▶ 10h Min power 10% ▶ 19h
LED and battery included LED e batteria inclusi	

Net weight 0,85 kg / 1,87 lbs | Pack Colli 1 | Energy class Classe energetica D

Kelp

Technopolymer knob Pomolo in tecnopolimero	Blown glass shade Cappello in vetro soffiato	Metal base Base in metallo	Code Codice	Euro €
Green Verde	Honey Miele	Brushed Rose Gold Oro Rosa Spazzolato	17081 7226	266,00

Chestnut

Technopolymer knob Pomolo in tecnopolimero	Blown glass shade Cappello in vetro soffiato	Metal base Base in metallo	Code Codice	Euro €
Taupe Grigio Caldo	Grey Grigio	Brushed Palladium Palladio Spazzolato	17081 3826	266,00

CE IP20 DTW EAC

Volum 14

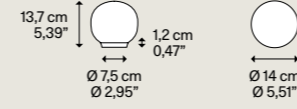

Net weight 0,80 kg / 1,76 lbs | Pack Colli 2

Silicone base Base in silicone	Blown glass diffuser Diffusore in vetro soffiato	Code Codice	Code Codice	Euro €
Translucent Traslucido	Glossy White Bianco Lucido	18781 1200	18781 120D	245,00

Light source Sorgente luminosa	Light source Sorgente luminosa
E14 LED T18 1x 5 W (max 10 W)	E14 LED T18 1x 5 W (max 10 W)
Ø max 6 cm Ø max 2,36"	Ø max 6 cm Ø max 2,36"
W/L max 9 cm W/L max 3,54"	W/L max 9 cm W/L max 3,54"
Bulb not included Lampadina non inclusa	Bulb not included Lampadina non inclusa
ON/OFF Switch the cord Interuttore ON/OFF sul cavo	Dimmer switch on the cord Interuttore con dimmer sul cavo

CE IP20 DIM 220-240V EAC

VAT excluded
IVA esclusa

Volum 22

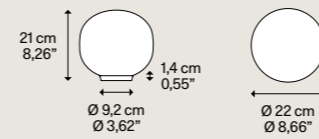

Net weight 1,26 kg / 2,77 lbs | Pack Colli 2

Silicone base Base in silicone	Blown glass diffuser Diffusore in vetro soffiato	Code Codice	Code Codice	Euro €
Translucent Traslucido	Glossy White Bianco Lucido	18782 1200	18782 120D	337,00

Light source Sorgente luminosa	Light source Sorgente luminosa
E27 LED T28 1x 10 W (max 25 W)	E27 LED T28 1x 10 W (max 25 W)
Ø max 6 cm Ø max 2,36"	Ø max 6 cm Ø max 2,36"
W/L max 12,5 cm W/L max 4,92"	W/L max 12,5 cm W/L max 4,92"
Bulb not included Lampadina non inclusa	Bulb not included Lampadina non inclusa
ON/OFF Switch the cord Interuttore ON/OFF sul cavo	Dimmer switch on the cord Interuttore con dimmer sul cavo

CE IP20 DIM 220-240V EAC

VAT excluded
IVA esclusa

Volum 29

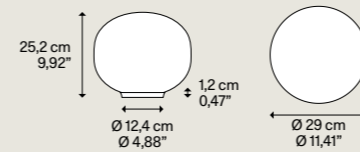

Net weight 2,16 kg / 4,76 lbs | Pack Colli 2

Silicone base Base in silicone	Blown glass diffuser Diffusore in vetro soffiato	Code Codice	Code Codice	Euro €
Translucent Traslucido	Glossy White Bianco Lucido	18783 1200	18783 120D	398,00

Light source Sorgente luminosa	Light source Sorgente luminosa
E27 LED T35 1x 13 W (max 25 W)	E27 LED T35 1x 13 W (max 25 W)
Ø max 9,8 cm Ø max 3,85"	Ø max 9,8 cm Ø max 3,85"
Bulb not included Lampadina non inclusa	Bulb not included Lampadina non inclusa
ON/OFF Switch the cord Interuttore ON/OFF sul cavo	Dimmer switch on the cord Interuttore con dimmer sul cavo

CE IP20 DIM 220-240V EAC

VAT excluded
IVA esclusa

Volum 42

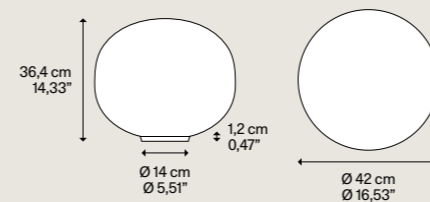

Net weight 3,44 kg / 7,58 lbs | Pack Colli 2

Silicone base Base in silicone	Blown glass diffuser Diffusore in vetro soffiato	Code Codice	Code Codice	Euro €
Translucent Traslucido	Glossy White Bianco Lucido	18784 1200	18784 120D	561,00

Light source Sorgente luminosa	Light source Sorgente luminosa
E27 LED T35 1x 21 W (max 25 W)	E27 LED T35 1x 21 W (max 25 W)
Ø max 9,8 cm Ø max 3,85"	Ø max 9,8 cm Ø max 3,85"
Bulb not included Lampadina non inclusa	Bulb not included Lampadina non inclusa
ON/OFF Switch the cord Interuttore ON/OFF sul cavo	Dimmer switch on the cord Interuttore con dimmer sul cavo

CE IP20 DIM 220-240V EAC

VAT excluded
IVA esclusa

SUSPENSION LAMP | CLUSTER SUSPENSION LAMP | CANOPY | WALL & CEILING LAMP | FLOOR & TABLE LAMP | ACCESSORY

Volum short 29

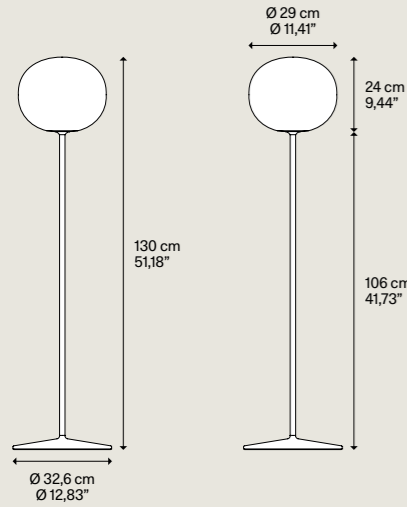

Net weight Peso netto	8,33 kg 18,36 lbs	Pack Colli	2	Energy class Classe energetica	D
--------------------------	----------------------	---------------	---	-----------------------------------	---

Metal structure
Montatura in metallo

White
Bianco

Blown glass diffuser
Diffusore in vetro soffiato

Glossy White
Bianco Lucido

Code
Codice

18771 1200

Euro €
595,00

Light source
Sorgente luminosa

E27 LED T28 1x 10 W (max 25 W)
 Ø max 6 cm
 Ø max 2,36"
 W/L max 12,5 cm
 W/L max 4,92"

Bulb not included
Lampadina non inclusa
 Dimmer switch on the cord
 Interruttore con dimmer sul cavo

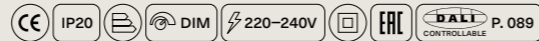

NEW LAMP

Volum long 29

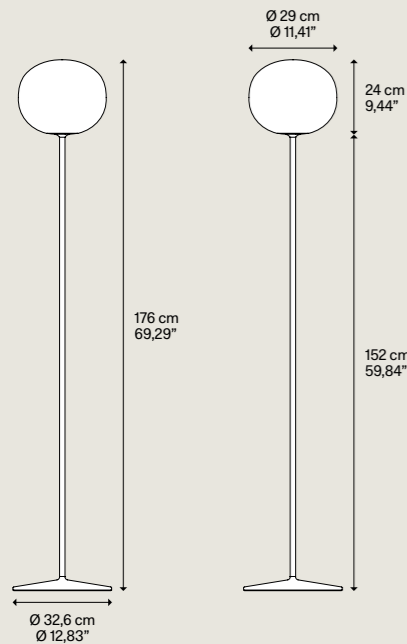

Net weight Peso netto	8,67 kg 19,11 lbs	Pack Colli	2	Energy class Classe energetica	D
--------------------------	----------------------	---------------	---	-----------------------------------	---

Metal structure
Montatura in metallo

White
Bianco

Blown glass diffuser
Diffusore in vetro soffiato

Glossy White
Bianco Lucido

Code
Codice

18773 1200

Euro €
680,00

Light source
Sorgente luminosa

E27 LED T28 1x 10 W (max 25 W)
 Ø max 6 cm
 Ø max 2,36"
 W/L max 12,5 cm
 W/L max 4,92"

Bulb not included
Lampadina non inclusa
 Dimmer switch on the cord
 Interruttore con dimmer sul cavo

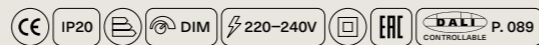

Volum short 42

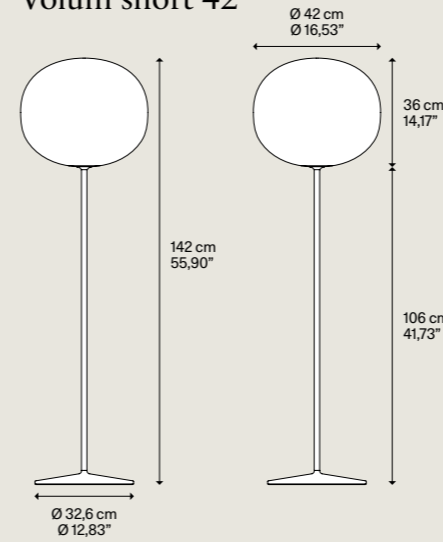

Net weight Peso netto	9,53 kg 21,01 lbs	Pack Colli	2	Energy class Classe energetica	D
--------------------------	----------------------	---------------	---	-----------------------------------	---

Metal structure
Montatura in metallo

White
Bianco

Blown glass diffuser
Diffusore in vetro soffiato

Glossy White
Bianco Lucido

Code
Codice

18772 1200

Euro €
711,00

Light source
Sorgente luminosa

E27 LED T35 1x 21 W (max 25 W)
 Ø max 9,8 cm
 Ø max 3,85"

Bulb not included
Lampadina non inclusa
 Dimmer switch on the cord
 Interruttore con dimmer sul cavo

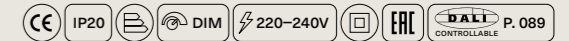

NEW LAMP

Volum long 42

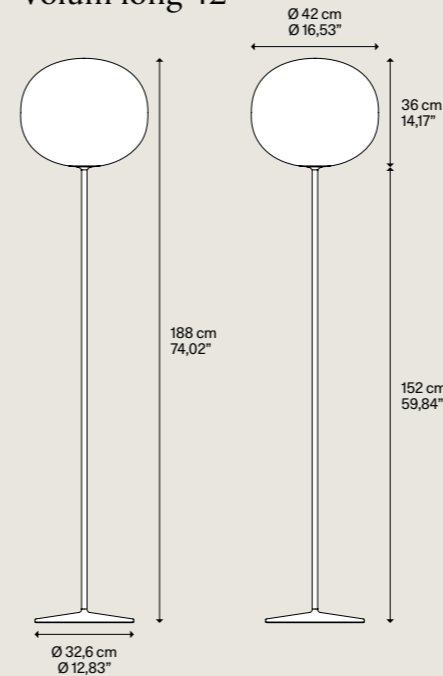

Net weight Peso netto	9,87 kg 21,75 lbs	Pack Colli	2	Energy class Classe energetica	D
--------------------------	----------------------	---------------	---	-----------------------------------	---

Metal structure
Montatura in metallo

White
Bianco

Blown glass diffuser
Diffusore in vetro soffiato

Glossy White
Bianco Lucido

Code
Codice

18774 1200

Euro €
796,00

Light source
Sorgente luminosa

E27 LED T35 1x 21 W (max 25 W)
 Ø max 9,8 cm
 Ø max 3,85"

Bulb not included
Lampadina non inclusa
 Dimmer switch on the cord
 Interruttore con dimmer sul cavo

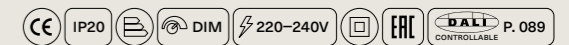

Light source Sorgente luminosa		Bulb dimension Dimensione lampadina		Lamp Lampada	Pack Colli	Code Codice	Euro €
E14 LED T18 5 W	2700 K 500 lm	CRI 90 MacAdam 3-Step	Ø 1,8 cm Ø 0,70"	Volum 14 P. 081	1	LAM-0017	24,00
E27 LED T28 10 W	2700 K 1000 lm	CRI 90 MacAdam 3-Step	Ø 2,8 cm Ø 1,10"	Volum 22, Volum short and long 29 P. 081, 082	1	LAM-0014	29,00
E27 LED T35 13 W	2700 K 1500 lm	CRI 90 MacAdam 3-Step	Ø 3,5 cm Ø 1,37"	Volum 29 P. 081	1	LAM-0015	39,00
E27 LED T35 21 W	2700 K 2010 lm	CRI 90 MacAdam 3-Step	Ø 3,5 cm Ø 1,37"	Volum 42, Volum short and long 42 P. 081, 083	1	LAM-0016	46,00

Dimmable bulbs/Lampadine dimmerabili

Accessories

CATEGORY RADIAL SYSTEM

Swag Kit for Radial Canopy

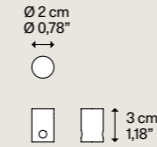

Net weight 0,02 kg
Peso netto 0,04 lbs

Pack Colli 1

Description Descrizione	Polycarbonate structure Struttura in policarbonato	System Sistema	Code Codice	Euro €	VAT excluded IVA esclusa
Wall and ceiling anchor for Radial System power cable / Max Ø 7 mm - 0,27" / Max capacity 5 kg - 11,02 lbs	<input type="radio"/> Clear Trasparente	Radial	999A4 00	22,00	CE
Cilindro di decentramento per Sistema Radiale cavo elettrico / Max Ø 7 mm - 0,27" / Portata max 5 kg - 11,02 lbs					

CATEGORY ACCESSORY

Back Plate Puzzle

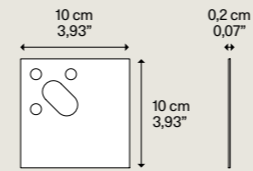

Net weight 0,07 kg
Peso netto 1,54 lbs

Pack Colli 1

Description Descrizione	Metal structure Montatura in metallo	System Sistema	Code Codice	Euro €	VAT excluded IVA esclusa
Optional backplate for Puzzle Wall and Ceiling	<input type="radio"/> Matte White - 9010 Bianco Opaco - 9010	Puzzle Series	14644 00	36,00	CE
Piastra a muro opzionale per Puzzle Parete e Soffitto					

CATEGORY ACCESSORY

Kit 4 Lights Line

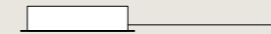

Net weight 0,37 kg
Peso netto 0,81 lbs

Pack Colli 1

Description Descrizione	Metal structure Montatura in metallo	System Sistema	Code Codice	Euro €	VAT excluded IVA esclusa
Extra Kit for decentralizing suspension with single power cable	<input type="radio"/> Matte White - 9016 Bianco Opaco - 9016	Line voltage cluster suspension lamps	999A00 1000	77,00	CE
Kit extra per decentrare sospensioni con cavo elettrico portante	<input type="radio"/> Matte Black - 9005 Nero Opaco - 9005		999A00 2000	77,00	

CATEGORY ACCESSORY

Kit Steel







Net weight 0,05 kg
Peso netto 0,11 lbs



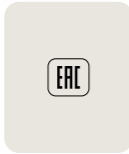

Pack Colli 1

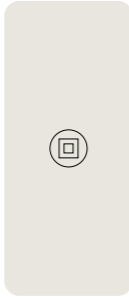



Description Descrizione	Metal structure Montatura in metallo	System Sistema	Code Codice	Euro €	VAT excluded IVA esclusa
Extra Kit for decentralizing suspension with steel cable	<input type="radio"/> Chrome Cromo	Kelly Series	999A01 4000	96,00	CE
Kit extra per decentrare sospensioni con funi d'acciaio					

Glossary



Certifications	
 <p>EN ● This certifies that the product complies with the provisions of EC directives.</p> <p>IT ● Attesta la conformità del prodotto alle disposizioni delle direttive comunitarie.</p>	 <p>EN ● EAC marking confirms the compliance of the products with the Eurasian Customs Union.</p> <p>IT ● EAC un marchio che attesta la conformità delle merci alle norme dell'Unione doganale euroasiatica.</p>

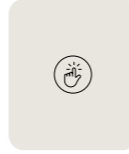

Insulation Class		
 <p>EN ● Class I device → connection to the yellow / green protective conductor (ground) is compulsory.</p> <p>IT ● Apparecchio in Classe I → è obbligatoria la connessione al conduttore di protezione giallo / verde (messa a terra).</p>	 <p>EN ● Class II → device in which protection against electric shock is based solely on double and / or reinforced insulation. These devices do not have earthing devices.</p> <p>IT ● Apparecchio in Classe II → nel quale la protezione contro la scossa elettrica si basa unicamente sul doppio isolamento e / o isolamento rinforzato. Questi apparecchi non prevedono dispositivi per la messa a terra.</p>	 <p>EN ● Class III → device in which protection against electric shock is based on a separated extra low voltage (SELV) supply and in which no higher voltages are produced.</p> <p>IT ● Apparecchio in Classe III → Apparecchio in cui la protezione contro la scossa elettrica si basa sull'alimentazione a bassissima tensione di sicurezza (SELV) e in cui non si producono tensioni superiori alla stessa.</p>

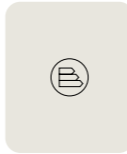
Levels of protection		
<p>EN ● IP → Level of protection. The IP code or ingress protection code indicates how well a device is protected against water and dust. It is defined by the International Electrotechnical Commission (IEC) which classifies and provides a guideline to the degree of protection provided by mechanical casings and electrical enclosures against intrusion, dust, accidental contact, and water.</p> <p>IT ● IP → Il codice IP è un parametro definito dallo standard internazionale IEC 60529 (pubblicato dalla Commissione elettrotecnica internazionale), che classifica e valuta il grado di protezione fornito da involucri meccanici e quadri elettrici contro l'intrusione di particelle solide (quali parti del corpo e polvere) e l'accesso di liquidi.</p>	 <p>EN ● An IP20 rating means the product is touchproof and will be resistant to dust or objects that are over 12 mm in size.</p> <p>IT ● Il grado di protezione IP20 significa che il prodotto è touchproof e resistente alle particelle di polvere o a oggetti di dimensioni superiori a 12 mm.</p>	 <p>EN ● An IP44 rating means that your product will be protected from solid particles that are over 1 mm in size and from low velocity sprays of water from every direction.</p> <p>IT ● Il grado di protezione IP44 significa che il prodotto è protetto da particelle solide di dimensioni superiori a 1 mm e da spruzzi d'acqua a bassa velocità provenienti da ogni direzione.</p>
 <p>EN ● An IP54 rating means that your product will be protected against contamination from limited amounts of dust and other particles. Additionally, you can be confident that it will be protected from water sprays from all directions.</p> <p>IT ● Il grado di protezione IP54 significa che il prodotto è protetto dalla contaminazione di quantità limitate di polvere e altre particelle. Inoltre, è garantita la protezione dagli spruzzi d'acqua provenienti da tutte le direzioni.</p>	 <p>EN ● An IP65 Rating means the product has the highest level of dust protection, and is able to withstand low-pressure water jets from all directions.</p> <p>IT ● La classificazione IP65 significa che il prodotto ha il massimo livello di protezione dalla polvere ed è in grado di resistere a getti d'acqua a bassa pressione provenienti da tutte le direzioni.</p>	 <p>EN ● Products with an IP67 Rating are waterproof due to their high levels of both solid and water ingress.</p> <p>IT ● I prodotti con classificazione IP67 sono impermeabili grazie agli elevati livelli di resistenza all'ingresso di acqua e solidi.</p>

Dimming		
 <p>EN ● Dimmable with TRIAC phase-cut dimmers (trailing edge).</p> <p>IT ● Dimmerabile con variatore a taglio di fase TRIAC.</p>	 <p>EN ● Dimmable with DALI dimmers.</p> <p>IT ● Dimmerabile con dimmer DALI.</p>	 <p>EN ● Controllable with DALI dimmers (non included).</p> <p>IT ● Controllabile con dimmer DALI (non inclusi).</p>
 <p>EN ● Dimmer on the cord included.</p> <p>IT ● Dimmer sul cavo incluso.</p>	 <p>EN ● Dim-to-Warm integrated dimmer.</p> <p>IT ● Dim-to-Warm dimmer integrato.</p>	 <p>EN ● Touch integrated dimmer.</p> <p>IT ● Touch dimmer integrato.</p>

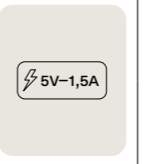
EU Energetic Label	
 <p>EN ● Energy efficiency classes (with a scale from A to G). It indicates the Energy efficiency class of a product.</p> <p>IT ● Classi di efficienza energetica (con una scala da A a G). Indica la classe di efficienza energetica di un prodotto.</p>	

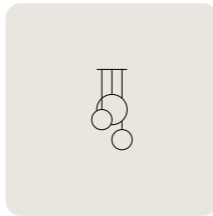
Voltage			
<p>EN ● Voltage of the lamp.</p> <p>IT ● Tensione dell'apparecchio.</p>			

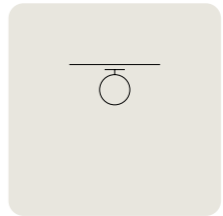
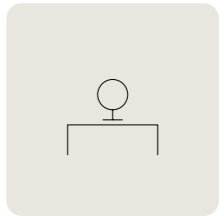
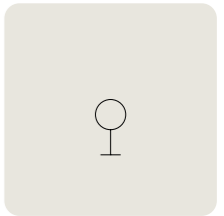
Category					
					
Cluster suspension Sospensione cluster	Suspension Sospensione	Wall Parete	Ceiling Soffitto	Table Tavolo	Floor Terra

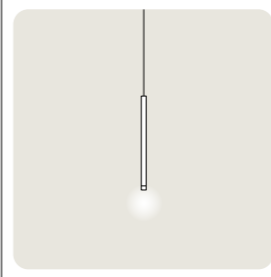
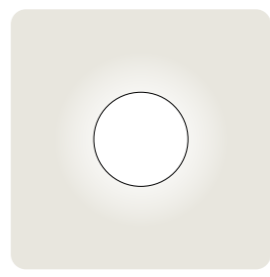
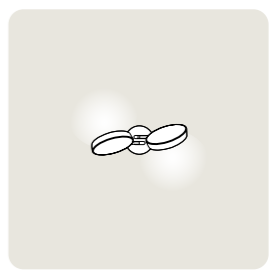
Type of light			
			
Diffused light Luce diffusa	Symmetrical diffused light Luce simmetrica diffusa	Indirect light Luce indiretta	Adjustable Orientabile

1

EN The LED-only light source contained in this fixture must only be replaced by the manufacturer, its support service or similarly qualified personnel.

IT La sorgente luminosa, esclusivamente LED, contenuta in questo apparecchio deve essere sostituita solo dal costruttore o dal suo servizio di assistenza o da personale altrettanto qualificato.

2

EN The LED driver contained in this fixture must only be replaced by the manufacturer, its support service or similarly qualified personnel.

IT Il driver LED contenuto in questo apparecchio deve essere sostituito solo dal costruttore o dal suo servizio di assistenza o da personale altrettanto qualificato.

PAGE	PRODUCT NAME	CATEGORY	KELVIN	ENERGY CLASS	ECODESIGN	
P. 028	A-Tube Nano	Cluster suspension lamp	2700 K 3000 K	D	1	2
P. 054	A-Tube Nano Swing	Recessed ceiling lamp	2700 K 3000 K	D	1	2
P. 029	A-Tube Nano Duo	Cluster suspension lamp	2700 K	D	1	2
P. 056	Aile	Wall lamp	2700 K 3000 K	E	1	
P. 079	Blow	Table lamp	2700 K	C	1	2
P. 056	Bugia	Ceiling lamp	2700 K 3000 K	F	1	
P. 030, 079	Cono di Luce	Cluster suspension lamp, Table lamp	2700 K	B	1	2
P. 076	Croma	Floor lamp	FROM 2200 K TO 3200 K	E	1	2
P. 080	Easy Peasy	Cordless table lamp	FROM 2200 K TO 2700 K	D	1	
P. 004	Elara	Suspension lamp	2700 K	D + E	1	2
P. 004	Elara	Suspension lamp	3000 K	D + F	1	2
P. 078	Hover	Floor lamp, Table lamp	2700 K	C	1	
P. 005, 031	IVY	Cluster suspension lamp, Suspension lamp, Central cluster suspension lamp	2700 K	D	1	2
P. 005, 031	IVY	Cluster suspension lamp, Suspension lamp, Central cluster suspension lamp	3000 K	C	1	2
P. 032	Jefferson	Cluster suspension lamp	2700 K	D	1	2
P. 034	Kelly Cluster	Cluster suspension lamp	2700 K	C	1	2
P. 058	Laser	Wall lamp	2700 K 3000 K	E	1	
P. 059	Nautilus	Wall lamp	2700 K 3000 K	F	1	
P. 059	Nautilus Dim-to-Warm	Wall lamp	FROM 2200 K TO 2700 K	E	1	2
P. 060	Nautilus Mini	Wall lamp	2700 K 3000 K	G	1	
P. 059	Nautilus	Ceiling lamp	2700 K 3000 K	F	1	
P. 061	Nautilus Spot	Ceiling lamp	2700 K 3000 K	F	1	
P. 034	Nostalgia	Cluster suspension lamp	2700 K	C	1	2
P. 036	Oblò	Cluster suspension lamp	2700 K 3000 K	D	1	2
P. 061	Pin-Up	Wall lamp, Ceiling lamp	2700 K 3000 K	E	1	
P. 063	Puzzle	Wall lamp, Ceiling lamp	2700 K 3000 K	E	1	
P. 064	Puzzle Mega	Wall lamp, Ceiling lamp	2700 K 3000 K	C	1	2
P. 062	Puzzle Round	Wall lamp, Ceiling lamp	2700 K 3000 K	E	1	
P. 037	Rain	Cluster suspension lamp	2700 K 3000 K	C	1	2
P. 038	Random	Cluster suspension lamp	2700 K 3000 K	D	1	2
P. 010	Random Cloud	Suspension lamp	2700 K 3000 K	D	1	2
P. 039	Random Solo	Cluster suspension lamp	2700 K 3000 K	D	1	2
P. 014	Random Stick	Suspension lamp	2700 K 3000 K	D	1	2
P. 070	Shift	Wall lamp	2700 K 3000 K	D	1	2
P. 020	Sky-Fall	Suspension lamp	2700 K 3000 K	E	1	2
P. 021	Sky-Fall Round	Suspension lamp	2700 K 3000 K	E	1	2
P. 042	Spider	Cluster suspension lamp	2700 K 3000 K	C	1	2
P. 067	Spider	Ceiling lamp	2700 K 3000 K	F	1	
P. 022	Tidal	Suspension lamp	2700 K 3000 K	C	1	2
P. 068	Tidal	Ceiling lamp	2700 K 3000 K	B	1	2

CATEGORY ACCESSORY

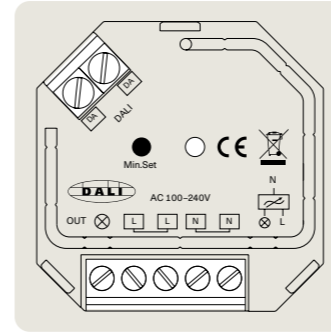

Description Descrizione	DALI Consumption Consumo DALI	Sizes Dimensioni	Code Codice
Input Voltage 100-240 VAC	2 mA max	Length 45,5 mm Width 45 mm Height 20,3 mm	999A02 00
Output Voltage 100-240 VAC			
Output Current 1,8 A max			

PAGE	PRODUCT NAME	CATEGORY	MAX CONNECTABLE PRODUCTS TO ONE CONVERTER
P. 029, 054	A-Tube Nano, A-Tube Nano Swing	Cluster suspension lamp, Ceiling lamp	25
P. 029	A-Tube Nano Duo	Cluster suspension lamp	25
P. 056	Aile	Wall lamp	12
P. 056	Bugia Single	Ceiling lamp	13
P. 057	Bugia Double	Ceiling lamp	6
P. 057	Bugia Triple	Ceiling lamp	4
P. 058	Bugia Mega	Ceiling lamp	4
P. 030, 079	Cono di Luce	Cluster suspension lamp, Table lamp	20
P. 004	Elara	Suspension lamp	6
P. 005, 031	IVY	Cluster suspension lamp, Suspension lamp, Central cluster suspension lamp	25
P. 032	Jefferson	Cluster suspension lamp	25
P. 034	Kelly Cluster	Cluster suspension lamp	18
P. 058	Laser	Wall lamp	12
P. 059	Nautilus, Nautilus Dim-to-Warm	Wall lamp	8
P. 060	Nautilus Mini	Wall lamp	16
P. 059	Nautilus	Ceiling lamp	16
P. 061	Nautilus Spot	Ceiling lamp	20
P. 034	Nostalgia	Cluster suspension lamp	11
P. 036	Oblò	Cluster suspension lamp	18
P. 061	Pin-Up	Wall lamp, Ceiling lamp	25
P. 063, 062	Puzzle, Puzzle Round single	Wall lamp, Ceiling lamp	12
P. 063, 062	Puzzle, Puzzle Round single	Wall lamp, Ceiling lamp	6
P. 063	Puzzle square & rectangle	Wall lamp, Ceiling lamp	6
P. 064	Puzzle Mega large	Wall lamp, Ceiling lamp	5
P. 064	Puzzle Mega small	Wall lamp, Ceiling lamp	6
P. 037	Rain	Cluster suspension lamp	11
P. 038	Random	Cluster suspension lamp	25
P. 010	Random Cloud	Suspension lamp	1
P. 039	Random Solo 10, 12, 14, 18	Cluster suspension lamp	25
P. 041	Random Solo 23, 28	Cluster suspension lamp	25
P. 014	Random Stick short	Suspension lamp	11
P. 016	Random Stick long	Suspension lamp	9
P. 070	Shift small	Wall lamp	9
P. 070	Shift large	Wall lamp	5
P. 020	Sky-Fall, Sky-Fall Round	Suspension lamp	14
P. 042	Spider	Cluster suspension lamp	11
P. 067	Spider	Ceiling lamp	20
P. 022	Tidal	Suspension lamp	4
P. 068	Tidal 45	Ceiling lamp	6
P. 068	Tidal 60	Ceiling lamp	4
P. 069	Tidal 75	Ceiling lamp	3
P. 053	A-Tube	Suspension lamp, Ceiling lamp	
P. 033	JIM	Cluster suspension lamp, Suspension lamp	
P. 008	Kelly dome	Suspension lamp	
P. 009	Kelly sphere	Suspension lamp	
P. 024, 043 071, 081	Volum	Cluster suspension lamp, Suspension lamp, Wall lamp, Ceiling lamp, Table lamp, Floor lamp	

The wattage of retrofit LED bulbs must not exceed 200W. Make sure to install only dimmable bulbs.

La potenza delle lampadine LED retrofit non deve superare i 200W. Assicurarsi di montare solo lampadine dimmerabili.

Extended dimming solutions for low-voltage products (not included)
Soluzioni di dimmerazione estese per prodotti a bassa tensione (non incluso)

PRODUCT NAME	DRIVER V _F (V)	DRIVER OPERATIONAL (mA)	LED POWER (W)	SUGGESTED DRIVER	MAX PRODUCTS SERIES WIRING	DRIVER POSITION	TYPE OF DIMMING
Kelly Cluster							
Nostalgia							
Oblò	20	350 max	6,9	TCI Meanwell Meanwell	mod. ATON 30/250-700 DALI mod. LCM-40DA mod. LCM-40BLE	2 4 4	Remote DALI-PUSH DALI-PUSH CASAMBI-PUSH
Rain							
Spider - Cluster suspension lamp							
Random Solo 12							
Random Solo 14	3	350 max	1	TCI Meanwell Meanwell	mod. ATON 30/250-700 DALI mod. LCM-40DA mod. LCM-40BLE	18 32 32	Remote DALI-PUSH DALI-PUSH CASAMBI-PUSH
Random Solo 18							
A-Tube Nano Duo	6	350 max	2	TCI Meanwell Meanwell	mod. ATON 30/250-700 DALI mod. LCM-40DA mod. LCM-40BLE	9 16 16	Remote DALI-PUSH DALI-PUSH CASAMBI-PUSH
A-Tube Nano							
IVY							
Jefferson	9	350 max	3	TCI Meanwell Meanwell	mod. ATON 30/250-700 DALI mod. LCM-40DA mod. LCM-40BLE	6 10 10	Remote DALI-PUSH DALI-PUSH CASAMBI-PUSH
Random Solo 23							
Random Solo 28							
Random	9	350 max	3	TCI Meanwell Meanwell	mod. ATON 30/250-700 DALI mod. LCM-40DA mod. LCM-40BLE	6 10 10	Remote DALI-PUSH DALI-PUSH CASAMBI-PUSH
Elara	26,8	1050 max	28,1	KGP TCI	mod. CC44W700-1050 DALI mod. Professionale DALI 38	1 1	Canopy DALI-PUSH DALI-PUSH
Tidal 45	24	550 max	27	KGP	mod. CC15W100-700 DALI NFC (2 pcs)	1	Built-in DALI-PUSH
Tidal 60	46	600 max	28	TCI ERP	DIRECT mod. Professionale DALI 38 mod. DAL50W-0850-56-T	1	Built-in DALI-PUSH DALI
Tidal 60	24	350 max	9	KGP EUCHIPS	INDIRECT mod. CC10W150-500 DALI NFC mod. PUP20D-1WMC	1	Built-in DALI-PUSH DALI-PUSH
Tidal 75	46	700 max	33	TCI ERP	DIRECT mod. Professionale DALI 38 mod. DAL50W-0850-56-T	1	Built-in DALI-PUSH DALI
Tidal 75	24	550 max	13	KGP EUCHIPS	INDIRECT mod. CC15W100-700 DALI NFC mod. PUP20D-1WMC	1	Built-in DALI-PUSH DALI-PUSH
Puzzle Mega Round small Puzzle Mega Square small	46	550 max	25	TCI ERP	mod. Professionale DALI 38 mod. DAL50W-0850-56-T	1	Remote DALI-PUSH DALI
Puzzle Mega Round large Puzzle Mega Square large	46	700 max	33	TCI ERP	mod. Professionale DALI 38 mod. DAL50W-0850-56-T	1	Remote DALI-PUSH DALI
Random Stick short	30	350 max	10,5	EUCHIPS	mod. PUP20D-1WMC	1	Canopy DALI-PUSH
Random Stick long	45	350 max	15,7	EUCHIPS	mod. PUP20D-1WMC	1	Canopy DALI-PUSH

► The suggested drivers are compatible with our lamps but not included. Lodes does not assume any responsibility/guarantee for their installation.

► I driver proposti sono compatibili con le nostre lampade ma non inclusi nelle certificazioni. Lodes non si assume nessuna responsabilità/garanzia sulla loro installazione.

Light sources power
Potenza fonti luminose

PAGE	PRODUCT NAME	CATEGORY	TOTAL POWER DRAW	LED QUANTITY & POWER	TOTAL LED POWER
P. 028	A-Tube Nano	Cluster suspension lamp	5 w	1× 3 w	3 w
P. 054	A-Tube Nano Swing	Recessed ceiling lamp	5 w	1× 3 w	3 w
P. 029	A-Tube Nano Duo	Cluster suspension lamp	4 w	2× 1 w	2 w
P. 056	Aile	Wall lamp	16 w	2× 8 w	16 w
P. 079	Blow	Table lamp	4,5 w	1× 4,5 w	4,5 w
P. 056	Bugia Single	Ceiling lamp	15 w	1× 15 w	15 w
P. 057	Bugia Double	Ceiling lamp	30 w	2× 15 w	30 w
P. 057	Bugia Triple	Ceiling lamp	45 w	3× 15 w	45 w
P. 058	Bugia Mega	Ceiling lamp	45 w	3× 15 w	45 w
P. 030	Cono di Luce	Cluster suspension lamp	10 w	1× 7 w	7 w
P. 079	Cono di Luce	Table lamp	7,5 w	1× 7,5 w	7,5 w
P. 076	Croma	Floor lamp	42 w	1× 42 w	42 w
P. 080	Easy Peasy	Cordless table lamp	5 w	1× 5 w	5 w
P. 004	Elara	Suspension lamp	32 w	18 w + 9 w	27 w
P. 078	Hover	Floor lamp, Table lamp	6,5 w	1× 6,5 w	6,5 w
P. 005 P. 031	IVY	Cluster suspension lamp, Suspension lamp, Central cluster suspension lamp	5 w	1× 3 w	3 w
P. 032	Jefferson	Cluster suspension lamp	5 w	1× 3 w	3 w
P. 033	JIM	Cluster suspension lamp, Suspension lamp	25 w		
P. 034	Kelly Cluster	Cluster suspension lamp	11 w	1× 7 w	7 w
P. 058	Laser	Wall lamp, Ceiling lamp	16 w	1× 16 w	16 w
P. 059	Nautilus Dim-to-Warm	Wall lamp	22 w	2× 7 w	14 w
P. 059	Nautilus	Wall lamp	24 w	2× 12 w	24 w
P. 060	Nautilus Mini	Wall lamp	12 w	1× 12 w	12 w
P. 059	Nautilus	Ceiling lamp	12 w	1× 12 w	12 w
P. 061	Nautilus Spot	Ceiling lamp	10 w	1× 10 w	10 w
P. 034	Nostalgia	Cluster suspension lamp	11 w	1× 7 w	7 w
P. 036	Oblò	Cluster suspension lamp	11 w	1× 7 w	7 w
P. 061	Pin-Up	Wall lamp, Ceiling lamp	8 w	1× 8 w	8 w
P. 063	Puzzle single square	Wall lamp, Ceiling lamp	16 w	1× 16 w	16 w
P. 063	Puzzle double square	Wall lamp, Ceiling lamp	32 w	2× 16 w	32 w
P. 063	Puzzle square & rectangle	Wall lamp, Ceiling lamp	32 w	2× 16 w	32 w
P. 062	Puzzle Round single	Wall lamp, Ceiling lamp	16 w	1× 16 w	16 w
P. 062	Puzzle Round double	Wall lamp, Ceiling lamp	32 w	2× 16 w	32 w
P. 064	Puzzle Mega small	Wall lamp, Ceiling lamp	30 w	3× 8 w	25 w
P. 064	Puzzle Mega large	Wall lamp, Ceiling lamp	38 w	4× 8 w	33 w
P. 037	Rain	Cluster suspension lamp	11 w	1× 7 w	7 w
P. 038	Random	Cluster suspension lamp	5 w	3× 1 w	3 w
P. 010	Random Cloud 7 Lights	Suspension lamp	35 w	7× 3 w	21 w
P. 011	Random Cloud 14 Lights	Suspension lamp	70 w	14× 3 w	42 w
P. 012	Random Cloud 19 Lights	Suspension lamp	95 w	19× 3 w	57 w
P. 013	Random Cloud 23 Lights	Suspension lamp	115 w	23× 3 w	69 w
P. 039	Random Solo 10, 12, 14, 18	Cluster suspension lamp	3 w	1× 1 w	1 w
P. 041	Random Solo 23, 28	Cluster suspension lamp	5 w	1× 3 w	3 w
P. 014	Random Stick short	Suspension lamp	17,5 w	3× 2 w + 4× 1 w	10 w
P. 016	Random Stick long	Suspension lamp	22 w	3× 3 w + 6× 1 w	15 w
P. 070	Shift small	Wall lamp	19,5 w	1× 16 w	16 w
P. 070	Shift large	Wall lamp	36 w	1× 32,5 w	32,5 w
P. 020	Sky-Fall, Sky-Fall Round	Suspension lamp	20 w	2× 8,5 w	17 w
P. 042	Spider	Cluster suspension lamp	11 w	1× 11 w	11 w
P. 067	Spider	Ceiling lamp	10 w	1× 10 w	10 w
P. 022	Tidal	Suspension lamp	40 w	16,5 w + 16,5 w	33 w
P. 068	Tidal 45	Ceiling lamp	30 w	27 w	27 w
P. 068	Tidal 60	Ceiling lamp	48 w	28 w + 9 w	37 w
P. 069	Tidal 75	Ceiling lamp	55 w	33 w + 13 w	46 w

Art. 1 Recital
Unless otherwise provided for in a separate written agreement between the parties, every sale of products of Lodes S.r.l., VAT 02992370276 (hereinafter, “the Seller”) is governed by the following General Conditions of Sale that must be considered as an essential part of this agreement and shall be deemed to have been accepted by the Buyer even though the latter has not signed them. Any clause unilaterally added by the Buyer in the documentation signed by it and /or in its correspondence, being against or in any case in addition to the general conditions or to those specific expressly approved in writing by the Seller, shall be deemed as not written and shall be of no effect.

Art. 2 Completion of the sale, quantities and prices
The sale is deemed to be completed once the Seller gives the written order confirmation also by fax and / or email or when deliveries are commenced in cases where the immediate delivery of the supply is requested, also in consideration of changes occurred and then accepted by the customer. The prices agreed are understood for products delivered ex works of the Seller and do not include services and accessory charges (such as VAT, special packaging, transport and installation costs, and /or assemblages and so on).

Art. 3 Delivery, risk transfer and transport
Products are delivered to the Buyer at the Seller's plant or at another place indicated in writing by the Seller, and the risk transfer takes place with the delivery of the goods to the first carrier or Buyer in the events of collection of goods directly carried out by the latter. The products always travel at the Buyer's sole risk also when the carrier is selected and appointed by the Seller, being the latter freed from all responsibilities after having delivered the products to the carrier, this delivery is deemed to all effects being carried out directly by the said Buyer. The delivery terms agreed are to be understood as indicative. If the Seller is responsible for delay of delivery for a period of up to 60 days, the Buyer is not entitled either to refuse the supply or to request the termination of the agreement and /or the compensation for any damages. If the delay in delivery exceeds 60 days, the Buyer is entitled to request – by registered letter – the cancellation of the order and the reimbursement of the advances if paid. In any event, the Seller shall not be liable for and /or direct and indirect damages of any nature and for any reason due to the delay or the failure to carry out the supply.

Art. 4 Reservation of title
The Buyer acquires property rights over the goods with the full payment of the price invoiced of the supplies but it takes the risks thereof as of the delivery.

Art. 5 Products features and conditions of use
Unless otherwise expressly agreed in writing by the parties, the conditions for using of the products are those communicated or in any case resulting from the drawings and technical specifications of the Seller, if any, or as described in the website www.lodes.com in relation to products. The quality levels of products are the standard quality levels of the Sellers, indicated in the relevant specifications as described on the Seller's website. It is always the Buyer's responsibility to identify and notify the Seller of the conditions of use of products before technically defining them. Failing any particular instructions from the Buyer, the Seller considers as usual conditions of use those it considered or described in its designs and technical documentation. Drawings, materials, and colours of the products included in catalogues/website and more generally in all advertising material are indicative. The Seller reserves the right, without notice, to modify the characteristics of its products, as well as their availability. Technical data, images, and information regarding the products are not binding on the Seller, who will not be held responsible for any discrepancies and / or illustrative and / or textual errors. Further product characteristics are contained in the respective technical sheets and /or instruction sheets.

Art. 6 Warranties
The products delivered are covered by a warranty for defects in material and manufacture for a period of 24 months as of the delivery if the Buyer is a natural person, otherwise the warranty period will be of 12 months as of the delivery. The Seller shall replace the products delivered in this warranty period being faulty due to factory defects or in alternative, at its discretion, pay the Buyer an amount equal to the price already invoiced of the said products, being expressly excluded and waived any other right or claim by the Buyer also as compensation for direct and /or indirect damages or cost repayment borne by it (such as recovery, technical assistance, recalling costs, etc.).

The Seller will anticipate the delivery of the replaced product, invoicing it regularly. Successively, when the product arrives to the Seller's warehouse, the latter will credit the amount of the defective product. The transport's costs will be paid by the Seller. Should the defected item be returned in an inadequate non-original packaging, with damages connected to the transport, The Seller will not credit any amount to the Buyer, and it will return the product to the sender at his own expenses. If the replacement was made for alleged defects in material and manufacture, but after the control carried out by the Seller, it is considered (i) unfounded, due to the absence of defects; (ii) further damaged by insufficient packaging in the return transport (iii) spoiled by tampering made by the Buyer, all transportation costs and the entire value of the product will be charged to the latter. Any defectiveness or non-compliance of products shall be reported by the Buyer by writing to the Seller – in order to be valid – within 8 days from receipt of goods; any hidden defects shall be reported by the Buyer by writing to the Seller – always in order to be valid – within 8 days as of the relevant discovery. It being understood that the Seller will not be responsible for any defect even though hidden, being notified in writing, after 24 months of the delivery of goods. The warranty does not apply where the defects identified are due to the Buyer's negligence and /or to the use of products being not compliant with the information and explanations in any case gave by the Seller, technical provisions, to incorrect design, application, assembly or manufacture of the facilities in which they are installed, to incorrect maintenance carried out by unauthorized personnel, to improper cleaning since it is made with materials and manners being not suitable, to incorrect storage, handling and transport, to improper or imprudent use, also in the event of electrical system and its capacity being not suitable, or to circumstances that in any case cannot be related to the production defectiveness by the Seller. Every single product of the Seller corresponds to the mark laid down by the European Community with Directive 93 / 68 (extension of Directive 73 / 23) to confirm, with a mark recognized all over Europe, that the lights have undergone the electrical safety test required by European standards EN-60598-1-2 II ed. + CEI EN 60598-1 IV ed. corresponding to Italian standards CEI 34-21 + CEI 34-23, electrical safety standards referred to by all institutions, including the IMQ. The products indicated with the logo UL and /or ETL corresponds to the standards UL 1598 /CAN /USA C22.2 No.250.0 o UL 153.

Art. 7 Buyer's Obligations
The Buyer is required to immediately take delivery of the goods given by the Seller to the carrier, or – where otherwise agreed – to timely collect them at the Seller's plant on the date on which the Seller communicates, by any means, that the goods are ready. Where the Buyer delays the collection of the production for a period exceeding 10 days, in addition to the payment of price it shall pay the Seller a proper compensation equal to 2% per day of the price invoiced for storing such products. The Buyer shall carry out the payments normally, in accordance with the terms and conditions specified in the invoice. For late payments it will be accrued by default without need of further notification interest under Legislative Decree no. 231 / 2002. In the event of payment delays, the Seller is entitled to immediately suspend any supply, even though it has concluded other agreements with the same Buyer. The failure to pay within the terms agreed will cause in any event the loss of favourable terms for the Buyer.

Art. 8 Replacement of the Product
If a product is returned for commercial reasons or for a mistake in the order made by the Buyer, the Seller will retain an amount equal to the 20% of the total price as cost for reconditioning the product. If the returned product had already been used and / or it has been returned in an inadequate original packaging, with consequent transport damages, the Seller will not credit to the Buyer any amount and it will return the product to the sender at his own expenses. Only the articles in the catalogue and in the price list in force at the time of the request will be taken into consideration. Transport's costs are always charged to the Buyer. The repair of damaged products will be authorized only if the damage has been caused by the Buyer. The Buyer, once accepted repair costs, will take care of returning the damaged product to the Seller's warehouse and it will pay the costs of transporting the repaired product.

Art. 9 Force majeure
If the Seller is unable to comply with the agreement due to force majeure or beyond its control events, the deadlines set for the supply are automatically extended for a period in which these effects continue. Where the obstacle to comply with the agreement is longer than 6 months, both parties may request the termination of the agreement and, in such event, the Seller repay the Buyer the advances received, if any, releasing itself from any additional obligation on it.

Art. 10 Agreement
In the event of execution of a specific agreement signed by the parties, the said agreement together with its Annexes provides for and summarizes the obligations validly undertaken by the parties and being binding for them. The fulfilment by the parties will be subject to effective evaluation of the actual performance of the contractual tasks and duties to be carried out in good faith, with honesty and fairness. These General Conditions of Sale shall apply to the agreement, unless otherwise provided in writing by the parties or expressly provided in the said agreement.

Art. 11 Privacy Policy
The Seller will use the data received from the Buyer in accordance with the provisions of the article 13 of EU Regulation 2016 /679 of 27 April 2016 (GDPR). For more information are available at the following link: www.lodes.com/privacy-policy.

Art. 12 Disputes
Any dispute which may arise concerning the signing, validity, interpretation, performance, amendment and termination of the agreement or of these General Conditions of Sale will be settled according to principles and rule set forth in Article 13 below.

Art. 13 Jurisdiction and Applicable Law
The Court of Milan, Italy, shall be held exclusively competent, being any other court of competent jurisdiction expressly excluded, and the Italian Law shall be applicable.

Art. 14 Website
These General Conditions of Sale are those indicated on the website www.lodes.com and may be printed and reproduced on paper. The Seller undertakes to update the website www.lodes.com by publishing on it the version of the General Conditions of Sale as amended from time to time.

Art. 1 Premessa
Salvo deroga risultante da apposito accordo scritto tra le parti, ogni compravendita di prodotti di Lodes S.r.l., P.IVA 02992370276 (di seguito: “Venditore”) è regolata dalle seguenti Condizioni Generali di Vendita che costituiscono parte essenziale del contratto e che si intendono pertanto accettate dal Compratore ancorché dallo stesso non sottoscritte. Qualsiasi clausola unilateralmente apposta dal Compratore nei documenti da lui sottoscritti e/o nella sua corrispondenza, che sia contraria o comunque in aggiunta alle seguenti condizioni generali od a quelle speciali espressamente approvate per iscritto dal Venditore, si intende come non scritta ed è priva di ogni effetto.

Art. 2 Perfezionamento della compravendita, quantitativi e prezzi
La compravendita si intende perfezionata con la conferma d'ordine scritta del Venditore anche a mezzo fax e/o posta elettronica o con l'inizio delle consegne per i casi in cui è stata richiesta l'immediata consegna della fornitura anche in presenza di modifiche intervenute e quindi accettate dal cliente. I prezzi concordati si intendono per prodotti consegnati franco stabilimento del Venditore e non comprendono prestazioni ed oneri accessori (quali IVA, imballo speciale, spese di trasporto, di installazione e/o montaggi e così via).

Art. 3 Consegna, trasferimento del rischio e trasporto
La merce viene consegnata al Compratore presso lo stabilimento del Venditore o in altro sito dallo stesso indicato per iscritto, ed il trasferimento del rischio avviene con la consegna della stessa al primo vettore o al Compratore nelle ipotesi di ritiro della merce da quest'ultimo direttamente eseguita. La merce viaggia sempre a rischio esclusivo del Compratore anche quando il vettore dovesse essere scelto ed incaricato dal Venditore, essendo quest'ultimo liberato da ogni responsabilità con la consegna dei prodotti al vettore, che ad ogni effetto si intende eseguita a mani dallo stesso Compratore. I termini di consegna pattuiti si intendono indicativi. In caso di ritardo nella consegna imputabile al Venditore per un periodo fino a 60 gg il Compratore non ha il diritto di rifiutare la fornitura, né di richiedere la risoluzione del contratto e/o il risarcimento di alcun danno. Se il ritardo nella consegna supera il termine di 60 gg il Compratore ha la facoltà di richiedere – con lettera raccomandata – l'annullamento dell'ordine e la restituzione degli anticipi eventualmente versati. Resta in ogni caso escluso qualsivoglia obbligo del Venditore di risarcimento danni diretti e/o indiretti di qualsiasi natura e per qualsiasi ragione, in dipendenza del ritardo ovvero della mancata esecuzione della fornitura.

Art. 4 Riserva di proprietà
Il Compratore acquista la proprietà della merce solo con il pagamento integrale del prezzo fatturato delle forniture ma ne assume i rischi dal momento della consegna.

Art. 5 Caratteristiche dei prodotti e condizioni di utilizzo
Salvo diverso ed espresso accordo scritto tra le parti, i parametri funzionali dei prodotti sono quelli espressi comunicati o comunque risultanti nei disegni e specifiche tecniche del Venditore se esistenti o su quanto indicato sul sito web www.lodes.com relativamente ai prodotti. I livelli di qualità dei prodotti forniti sono quelli standard del Venditore, evidenziati nelle relative specifiche o su quanto indicato e desumibile sul sito web del Venditore. È onere del Compratore individuare e comunicare al Venditore le condizioni di utilizzo dei prodotti prima della relativa definizione tecnica. In mancanza di indicazioni da parte del Compratore il Venditore considera condizioni di utilizzo quelle di prassi dallo stesso considerate o esplicitate nei propri disegni e documentazione tecnica. I disegni, i materiali ed i colori dei prodotti inseriti sui cataloghi/sito internet e più in generale in tutto il materiale pubblicitario, si intendono a titolo indicativo. Il Venditore, si riserva il diritto, senza alcun preavviso, di modificare le caratteristiche dei propri prodotti,

così come la disponibilità degli stessi. I dati tecnici, le immagini e le informazioni riguardo ai prodotti non sono vincolanti per il Venditore, il quale non risponderà per eventuali difformità e/o errori illustrativi e/o testuali. Ulteriori caratteristiche dei prodotti sono contenute nelle relative schede tecniche e/o fogli di istruzione.

Art. 6 Garanzie
I prodotti forniti sono coperti da garanzia per difetti di materiale e/o fabbricazione per un periodo di 24 mesi dalla consegna se il Compratore risulta essere una persona fisica, diversamente il periodo di garanzia sarà di 12 mesi dalla consegna. Il Venditore sostituisce i prodotti resi in detto periodo di garanzia e riconosciuti difettosi per vizi d'origine ovvero in alternativa ed a sua scelta accredita al Compratore una somma pari al prezzo già fatturato dei prodotti stessi, restando espressamente escluso e rinunciato qualsiasi diverso diritto o pretesa del Compratore anche a titolo di risarcimento danni diretti e/o indiretti o di rimborso di costi dallo stesso sostenuti (quali costo di riprese, di assistenza tecnica, di richiamo, ecc.). Il Venditore anticiperà l'invio del prodotto in sostituzione, fatturandolo regolarmente, andando poi ad accreditare l'importo alla riconsegna del prodotto difettoso reso. Le spese di trasporto saranno a carico del Venditore. Qualora l'articolo oggetto del reso venisse riconsegnato in un imballo non originale inadeguato con conseguenti danni da trasporto, il Venditore non accrediterà al Compratore alcun importo e rinvierà al mittente, a sue spese il prodotto. Qualora il reso venisse effettuato per presunti vizi d'origine ma dopo il controllo effettuato dal Venditore lo stesso venisse ritenuto (i) infondato, per assenza di vizi; (ii) ulteriormente danneggiato da insufficiente imballaggio nel trasporto di ritorno (iii) viziato da manomissione posta in essere dal Compratore, verranno addebitati a quest'ultimo tutti i costi di trasporto nonché l'intero valore del prodotto. Eventuali difettosità o non conformità dei prodotti devono essere segnalate dal Compratore per iscritto al Venditore – a pena di decadenza – entro e non oltre 8 gg dalla data di ricevimento della merce; eventuali difetti occulti devono essere segnalati dal Compratore per iscritto al Venditore – sempre a pena di decadenza – entro 8 gg dalla relativa scoperta. Resta inteso che il Venditore non sarà responsabile per alcun vizio ancorché occulto, comunicato per iscritto, oltre 24 mesi dalla consegna della merce. La garanzia non opera ove i difetti rilevati siano imputabili a negligenza del Compratore e/o ad impiego dei prodotti non conforme con le informazioni e le spiegazioni in ogni caso fornite dal Venditore, alle prescrizioni tecniche, ad errata progettazione, applicazione, montaggio o fabbricazione delle strutture ove sono installati, ad errata manutenzione operata da personale non autorizzato, a pulizia impropria in quanto effettuata con modalità o materiali non idonei, ad errato magazzino, movimentazione e trasporto, ad uso improprio od incauto, anche in caso di impianto elettrico e portata dello stesso non idonea, ovvero a circostanze che comunque non possono ricollegarsi a difettosità di produzione da parte del Venditore. Ogni singolo prodotto del Venditore è conforme alla marcatura richiesta dalla Comunità Europea con la direttiva 93/68 (ampliamento della direttiva 73/23) per confermare con una marcatura riconosciuta in tutta Europa, che le lampade sono state sottoposte alle prove di sicurezza elettrica richieste dalle norme Europee EN-60598-1-2 II ed. + CEI EN 60598-1 IV ed. corrispondenti norme italiane CEI 34-21 + CEI 34-23, norme per la sicurezza elettrica a cui fanno riferimento tutti gli istituti, compreso l'IMQ. I prodotti indicati con il marchio UL e/o ETL sono conformi alla normativa UL 1598 /CAN /USA C22.2 No.250.0 o UL 153.

Art. 7 Obblighi del Compratore
Il Compratore è tenuto a prendere immediatamente in consegna i prodotti affidati dal Venditore al vettore, ovvero – se diversamente concordato – apuntualmente ritirarli presso lo stabilimento del Venditore alla data di comunicazione di merce pronta che potrà avvenire con ogni mezzo da parte del Venditore. Ove il Compratore ritardi il ritiro dei prodotti per un periodo superiore a 10 gg, oltre al pagamento del prezzo deve corrispondere al Venditore un adeguato compenso pari al 2% al giorno dell'importo fatturato per il magazzino

degli stessi. Il Compratore deve effettuare i pagamenti normalmente, con le modalità e nei termini precisati in fattura. Sui ritardati pagamenti decorreranno, di pieno diritto e senza necessità di costituzione in mora, gli interessi di cui al D.lgs. n. 231 /2002. In caso di ritardo dei pagamenti il Venditore ha diritto a sospendere immediatamente ogni fornitura, anche se dipendente da altri contratti con lo stesso Compratore. Il mancato pagamento nei termini pattuiti comporta in ogni caso la decadenza del Compratore dal beneficio del termine.

Art. 8 Resi
In caso di reso commerciale o in caso di reso per errore del Compratore, il Venditore tratterà un importo pari al 20% minimo del totale a titolo di costo di ricondizionamento dell'articolo. Qualora l'articolo oggetto del reso fosse già stato utilizzato e/o venisse riconsegnato in un imballo non originale inadeguato, con conseguenti danni da trasporto, il Venditore non accrediterà al Compratore nessun importo e rinvierà al mittente, a sue spese, il reso. Verranno presi in considerazione solamente gli articoli presenti nel catalogo e nel listino in vigore al momento della richiesta. Le spese di trasporto sono sempre a carico del Compratore. I resi per riparazione vanno autorizzati solo se la causa del danno è dipesa dal Compratore che dopo aver accettato il costo di riparazione si occuperà a proprie spese di rispedire l'articolo danneggiato in sede e si accollerà poi i costi relativi al trasporto del prodotto riparato.

Art. 9 Forza maggiore
Qualora il Venditore sia impossibilitato a rispettare il contratto per cause di forza maggiore o comunque indipendenti dalla sua volontà, i termini previsti per l'esecuzione della fornitura sono automaticamente prorogati per un periodo equivalente al perdurare degli effetti di tali cause. Qualora la causa imputativa continui per più di 6 mesi entrambe le parti possono chiedere la risoluzione del contratto ed in tal caso il Venditore restituisce al Compratore gli anticipi eventualmente ricevuti, con esclusione di ogni e qualsiasi onere ulteriore a suo carico.

Art. 10 Contratto
In caso di sottoscrizione di apposito contratto lo stesso con i suoi allegati contiene e riassume le obbligazioni validamente assunte dalle parti e per esse vincolanti. L'adempimento delle parti sarà oggetto di valutazione dell'effettiva esecuzione dei compiti e doveri contrattuali, da effettuarsi in buona fede, onestà e con equità. Le presenti Condizioni Generali di Vendita si applicheranno al contratto salvo deroga risultante da atto scritto o in esso contratto esplicitamente prevista.

Art. 11 Trattamento dei dati personali
Il Venditore utilizzerà i dati ricevuti dal Compratore conformemente alle disposizioni vigenti in materia di Privacy secondo l'art.13 del Regolamento Europeo 2016 /679 (GDPR). Maggiori informazioni sono disponibili al seguente link www.lodes.com/it/privacy-policy.

Art. 12 Controversie
Qualora dovesse verificarsi una qualsivoglia controversia avente ad oggetto la formazione, validità, interpretazione, esecuzione, modifica e risoluzione del contratto o delle presenti Condizioni Generali di Vendita, questa sarà risolta secondo i principi e le regole indicate nell'articolo 13 che segue.

Art. 13 Foro competente e legge applicabile
Foro esclusivamente competente sarà quello di Milano con esplicita esclusione di ogni altro foro alternativamente competente, e la legge applicabile quella italiana.

Art. 14 Sito web
Le presenti Condizioni Generali di Vendita, sono quelle risultanti sul sito web www.lodes.com e sono stampabili e riproducibili su supporto cartaceo. Il Venditore si impegna ad aggiornare il sito web www.lodes.com mediante la pubblicazione sullo stesso della versione di Condizioni Generali di Vendita di volta in volta modificata.

Head Offices & Showroom

Lodes – via Pialoi 32,
30020 Marcon, Venice – Italy
T +39 041 45 69 266
General information
info@lodes.com

Lodes USA LLC
560 Springfield Avenue, Suite B
Westfield, NJ 07090 – USA
D 201 903 0020
usa@lodes.com

Lodes' Hong Kong Office
Unit 507 Arion Commercial
Centre, 2–12 Queen's Road West
Sheung Wan – Hong Kong

Lodes Milan Showroom

via della Moscova 33,
Cortile della Seta
20121 Milano (MI) – Italy
T +39 02 4940 0999
milano@lodes.com

Lodes Flagships

Lodes Paris – Novaluce
131 rue du Faubourg
Saint Honoré,
75008 Paris 8e – France
T +33 (0) 1 42 89 03 18
paris@lodes.com

Lodes Cologne
Design Post Köln
Deutz-Mülheimer-Str. 22a
50679 Köln – Germany

Lodes products were made using specific processing techniques and treatments, aimed at creating unique results. Any differences between individual items are therefore designed to ensure that every single product is special and unique.

I prodotto *Lodes* sono stati realizzati con particolari lavorazioni e trattamenti al fine di ottenere risultati unici. Per tale ragione, eventuali differenze da pezzo a pezzo sono volte a garantire specialità ed unicità ad ogni singolo prodotto.

