

# LODES

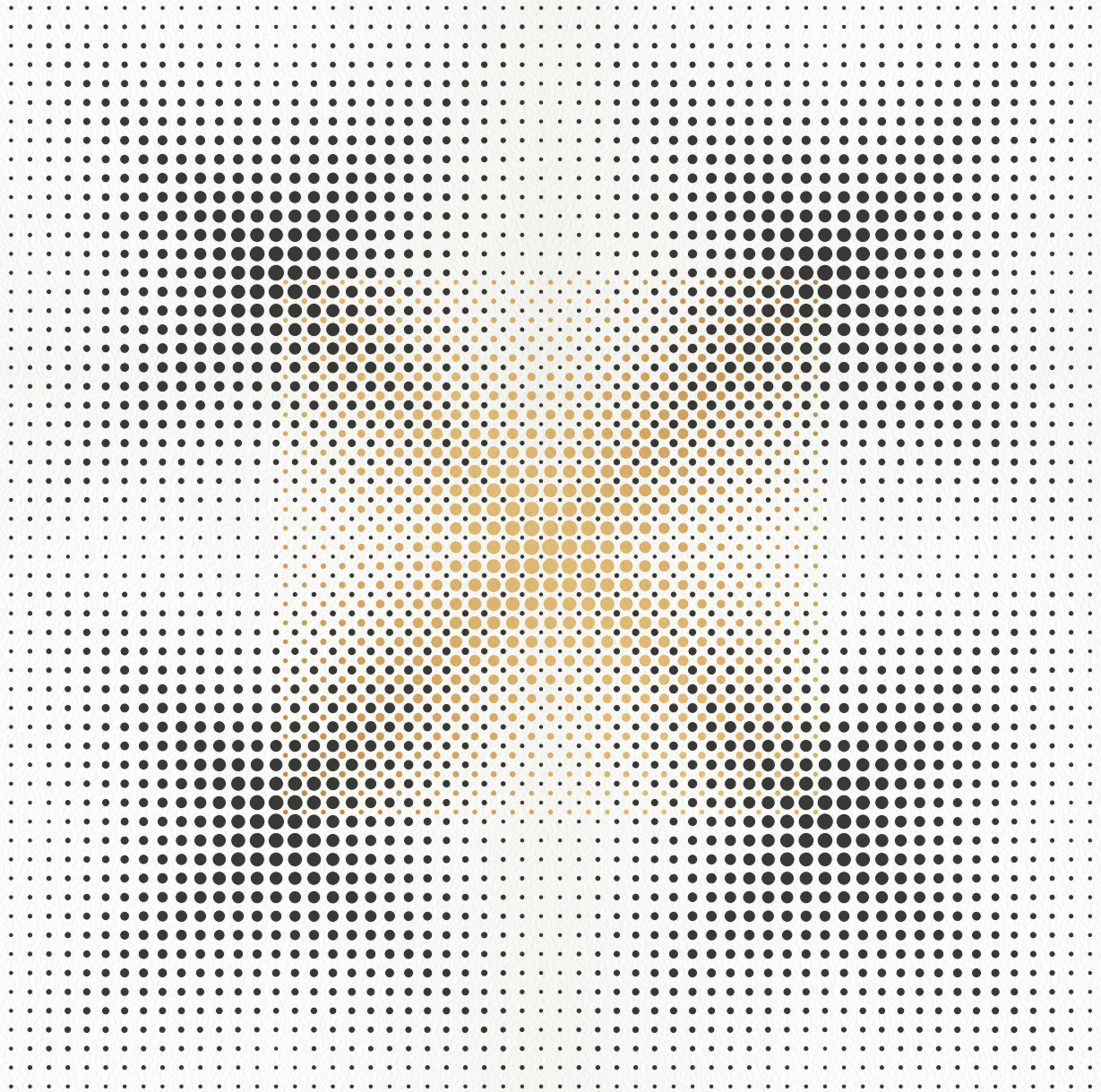



P.	PRODUCT NAME	CATEGORY
426	A Aile	Wall lamp
260	A-Tube	Cluster suspension lamp, Ceiling lamp
226	A-Tube Nano	Cluster suspension lamp
226	A-Tube Nano Swing	Ceiling lamp
250	A-Tube Nano Duo	Cluster suspension lamp
444	B Blow	Table lamp
406	Bugia	Ceiling lamp
472	C Cima	Suspension lamp, Floor lamp
306	Cono di Luce	Cluster suspension lamp, Table lamp
458	Croma	Floor lamp
450	E Easy Peasy	Cordless table lamp
052	Elara	Suspension lamp
464	F Flar	Table lamp, Floor lamp
434	H Hover	Table lamp, Floor lamp
270	I IVY I	Cluster suspension lamp
270	IVY V	Suspension lamp, Central cluster suspension lamp
188	J Jefferson	Cluster suspension lamp
284	JIM	Cluster suspension lamp, Suspension lamp
076	K Kelly	Suspension lamp
296	Kelly Cluster	Cluster suspension lamp
420	L Laser	Wall lamp
360	N Nautilus	Ceiling lamp, Wall lamp
360	Nautilus Mini	Wall lamp
174	Nostalgia	Cluster suspension lamp
090	O Oblò	Cluster suspension lamp
414	P Pin-Up	Wall lamp, Ceiling lamp
388	Puzzle	Wall lamp, Ceiling lamp
394	Puzzle Mega	Wall lamp, Ceiling lamp
378	Puzzle Round	Wall lamp, Ceiling lamp
214	R Rain	Cluster suspension lamp
124	Random	Cluster suspension lamp
038	Random Cloud	Suspension lamp
104	Random Solo	Cluster suspension lamp
020	Random Stick	Suspension lamp
350	S Shift	Wall lamp
062	Sky-Fall	Suspension lamp
062	Sky-Fall Round	Suspension lamp
198	Spider	Cluster suspension lamp, Ceiling lamp
330	T Tidal	Suspension lamp, Ceiling lamp
144	V Volum	Cluster suspension lamp, Suspension lamp, Wall lamp, Ceiling lamp, Table lamp, Floor lamp

LODES INTERACTIVE CATALOG  
Click on the name of the lamp to go directly to the corresponding chapter.

Clicca sul nome della lampada per accedere direttamente al capitolo corrispondente.



## ED. 2025 Collection Catalogue



*Lodes* designs and manufactures lighting solutions that enhance the quality of living for those who choose them in any environment and situation. We seek a balance between form and functionality to elevate every space with a distinctive decorative touch, without compromising on design or utility. Founded in 1950, *Lodes* narrates an evolutionary journey through three generations, from a pure passion for light to contemporary creations that seamlessly blend design and technological innovation.

*Lodes* progetta e produce soluzioni illuminotecniche che migliorino la qualità dell'abitare di chi le sceglie, in qualsiasi ambiente e situazione. Cerchiamo l'equilibrio tra forma e funzionalità per valorizzare ogni spazio con un segno decorativo distintivo, senza compromessi né rinunce. Nata nel 1950, *Lodes* racconta un percorso evolutivo attraverso tre generazioni, dalla pura passione per la luce alle creazioni contemporanee che coniugano design e ricerca tecnologica.

About us  
Click here to visit the website



Lodes Collections  
Click here to visit the website

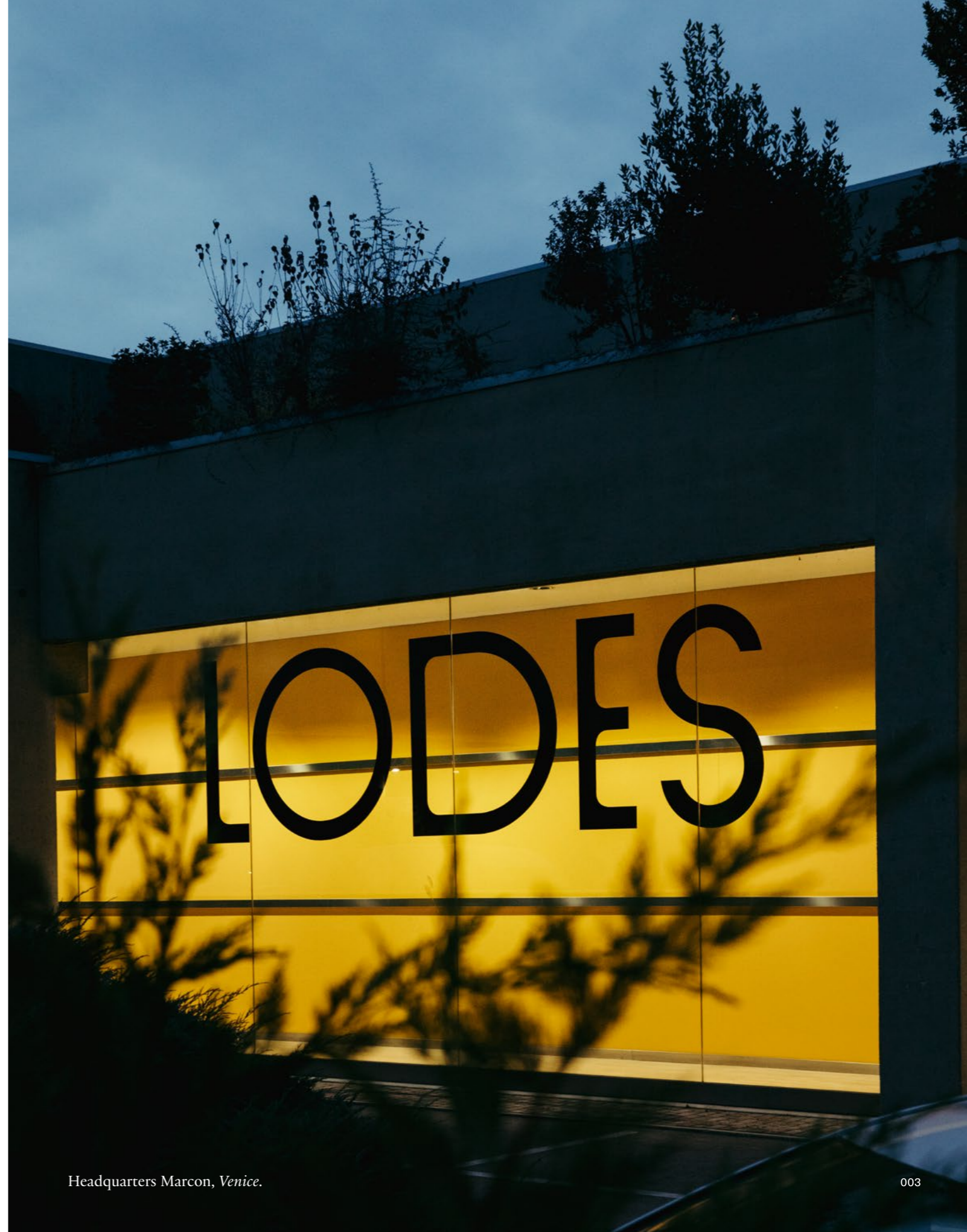



# Lodes Timeline 1950–Today

The company was founded by the grandfather Angelo Tosetto.



1950

1985

Massimiliano Tosetto, Andrea's son, joins the company as Export Sales Manager. After ten years, in 2013, he's appointed General Manager of the company.



Massimiliano Tosetto

2004–2013

1997

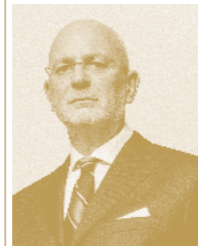

Andrea Tosetto

Andrea Tosetto, takes over the company, renames it Studio Italia Design, embracing a more contemporary language and transitioning to digital design.

The three children of the founder take over the company and change its name to Tre-T Lighting.

2014–2015



The company starts to develop proprietary AC LED modules and new products are added to the catalogue, such as the iconic *Kelly* lamp, designed by Andrea Tosetto. In the same year, the turnover doubles vs the previous year.

2019, 2020, 2021  
The partnership with Luca Nichetto and other new designers results in products such as *Jefferson*, *Easy Peasy* and *Croma* by Luca Nichetto, *Cima*, design by Marco Dessì.

2020  
Studio Italia Design becomes *Lodes*.

LODES

2019, 2020, 2021

2021

The *Diesel Living* with *Lodes* line makes its debut to mark the global exclusive collaboration between *Diesel* and *Lodes*.

2022

The company continues to see an increase in terms of turnover and announces its first collaboration with international architecture and design studio, Snøhetta. The partnership sees the launch of a new lighting collection entitled *Volum*.

*Lodes* lands in Milan. The first *Lodes*' space in the world.



Lodes announces strategic expansion in North America – new branch in New York. In the same year *Lodes* presents *Cono di Luce* in collaboration with Ron Arad.

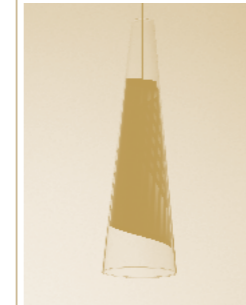

*Cono di Luce*, design by Ron Arad, 2023

2023

2024

The flagship spaces in Paris and Cologne, dedicated to professionals, customers & partners, promote moments of interaction and discussion on light and solutions designed by the company. The company presents *Oblò* in collaboration with Paola Navone – OTTO Studio.



2025

The company announces its first collaboration with the international architecture Studio Marco Piva. The partnership sees the launch of a new wall lamp entitled *Shift*.



*Mastery* represents the expertise accumulated through years of direct experience. The choice of using different materials and processing techniques that combine innovation and skills acquired over time allows *Lodes* to create enduring and meaningful lighting solutions.

Il *Mestiere* è il saper fare consolidato attraverso l'esperienza diretta nel corso degli anni. La scelta di utilizzare materie diverse e tecniche di lavorazione che uniscono innovazione e abilità acquisite nel tempo consente a *Lodes* di creare soluzioni illuminotecniche durevoli e ricche di significato.

## Blown Glass



Blown Glass  
View the video



*Lodes* Mastery – Chapter I  
Blown Glass

*Blowing* is an ancient glassmaking technique that finds one of its highest expressions in Venice, the territory of *Lodes*. The company's founder passed on the secrets learned from master glassblowers and the passion for this refined art to contemporary generations, who continue to use the age-old technique of glassblowing in many collections in the catalogue.

La *soffiatura* è un'antica tecnica di lavorazione del vetro che trova una delle sue alte espressioni proprio a Venezia, il territorio di *Lodes*. Il fondatore dell'azienda ha trasmesso i segreti appresi dai mastri vetrai e la passione per questa raffinata arte alle generazioni contemporanee, che continuano a utilizzare la millenaria tecnica della soffiatura in molte collezioni a catalogo.

## Metal



Metal  
View the video



*Lodes* Mastery – Chapter II  
Metal

*Metals* are among the most resistant materials in the world. By combining skills perfected over the years and contemporary techniques, *Lodes* is able to shape them according to the specific needs of each project, giving life to luminous creations that blend design and durability over time.

I *metalli* sono tra i materiali più resistenti al mondo: unendo abilità perfezionate negli anni e tecniche contemporanee, *Lodes* riesce a plasmarli in funzione delle specifiche esigenze di ogni progetto per dar vita a creazioni luminose che coniugano design e resistenza nel tempo.

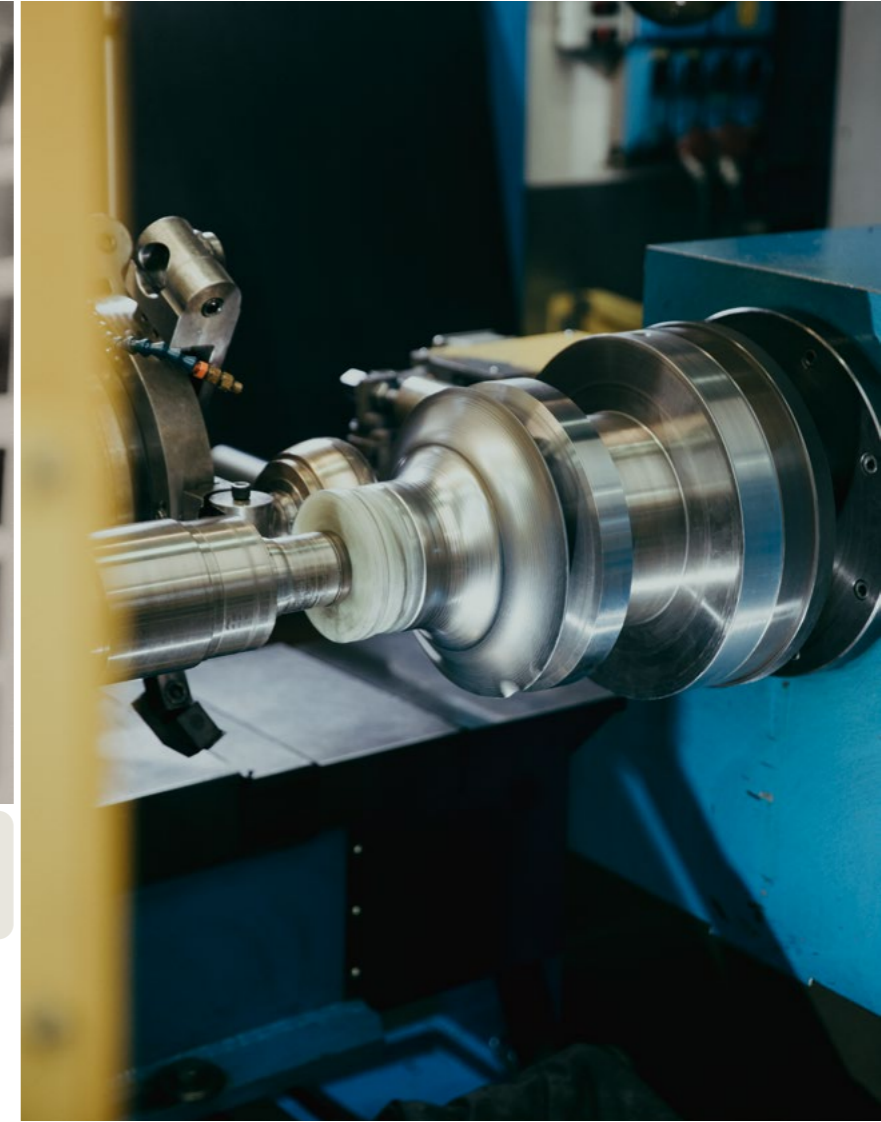



# PCB–Printed Circuit Board

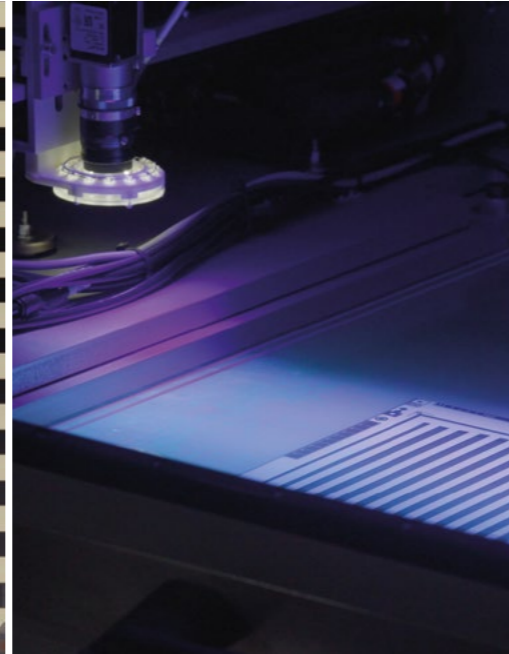

PCB  
View the video  
↓

# Vacuum metallisation process



Vacuum Metallisation  
View the video  
↓



A thin, flexible, and insulating sheet of glass fibre forms the basis for a copper path serving as an electrical conductor for the LED. Thanks to its expressive and aesthetic properties, the PCB enables Lodes to create innovative designs that alternate between different reflections of light.

Un sottile foglio di fibra di vetro, flessibile e isolante, è la base per un path di rame che funge da conduttore elettrico per il LED. Grazie alle sue proprietà espressive ed estetiche, il PCB consente a Lodes di realizzare inedite creazioni che alternano diversi riflessi di luce.

The term *metallisation* refers to the deposition of a thin film of metal on a substrate under vacuum conditions. The vacuum allows metal molecules to move from the evaporation source to the surface being coated without being hindered by air or other gaseous particles. Vacuum metallisation enables the coating of materials regardless of shape and size, resulting in decorative objects with a shiny, metallic appearance that is also available in various colours.

Con il termine *Metallizzazione* si intende la deposizione su un substrato di un sottile film di metallo in condizione di vuoto. Il vuoto consente alle molecole di metallo di muoversi dalla sorgente di evaporazione fino alle superfici da rivestire senza incontrare l'impedimento d'aria e altre particelle gassose. La metallizzazione in vuoto permette di rivestire il materiale indistintamente dalla forma e dimensione ottenendo oggetti decorativi dall'aspetto brillante, metallico oltre che variamente colorato.



# Quality of Light

Our expertise lies in combining functional lamp *design* with *state-of-the-art LED technology* that can decorate and illuminate spaces in an exceptional way. The *quality of light* is a priority for us and it materialises in offering the best possible light in every context, whether residential or work-related. Colour consistency of light sources combined with a high *Colour Rendering Index* allows our lamps to make objects in a space stand out and ensure a constant light effect over time.

La nostra expertise consiste nel combinare soluzioni di illuminazione dal *design funzionale* con una *tecnologia LED* all'avanguardia, in grado di decorare e illuminare gli spazi in modo eccezionale. La *qualità della luce* è per noi una priorità e si concretizza nell'offrire la migliore luce possibile in ogni contesto, che sia abitativo o di lavoro. La *coerenza cromatica* delle sorgenti luminose, unita a un elevato indice di resa cromatica, consente alle nostre lampade di far risaltare gli oggetti in uno spazio e di garantire un effetto luminoso costante nel tempo.

Step MacAdam  $\leq 3$

Colour Rendering Index (CRI)  $\geq 90$

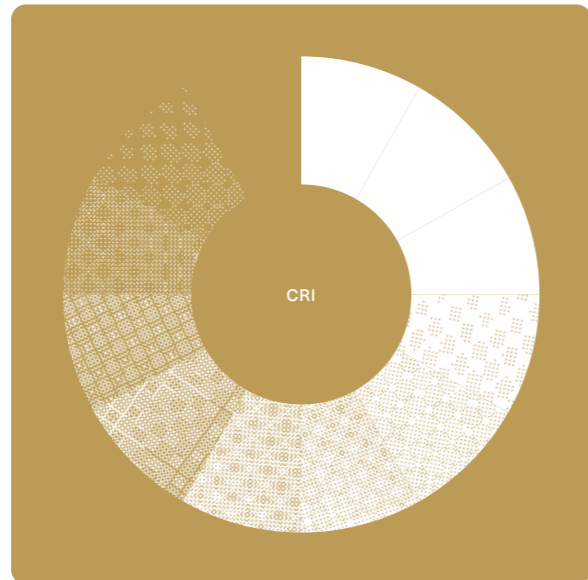
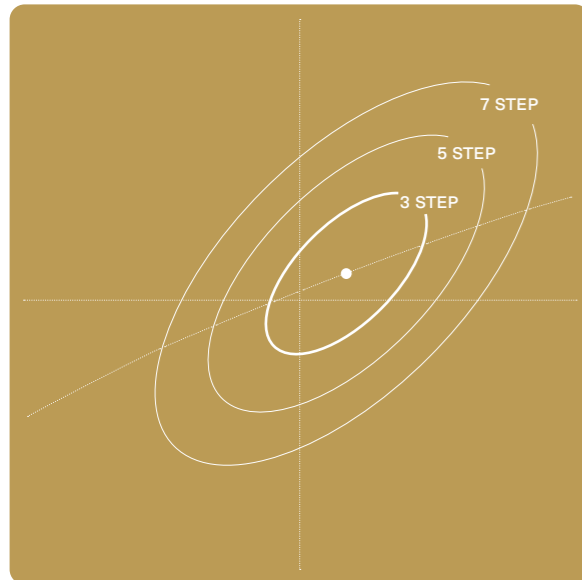

# Lighting Solutions

## Lighting effects

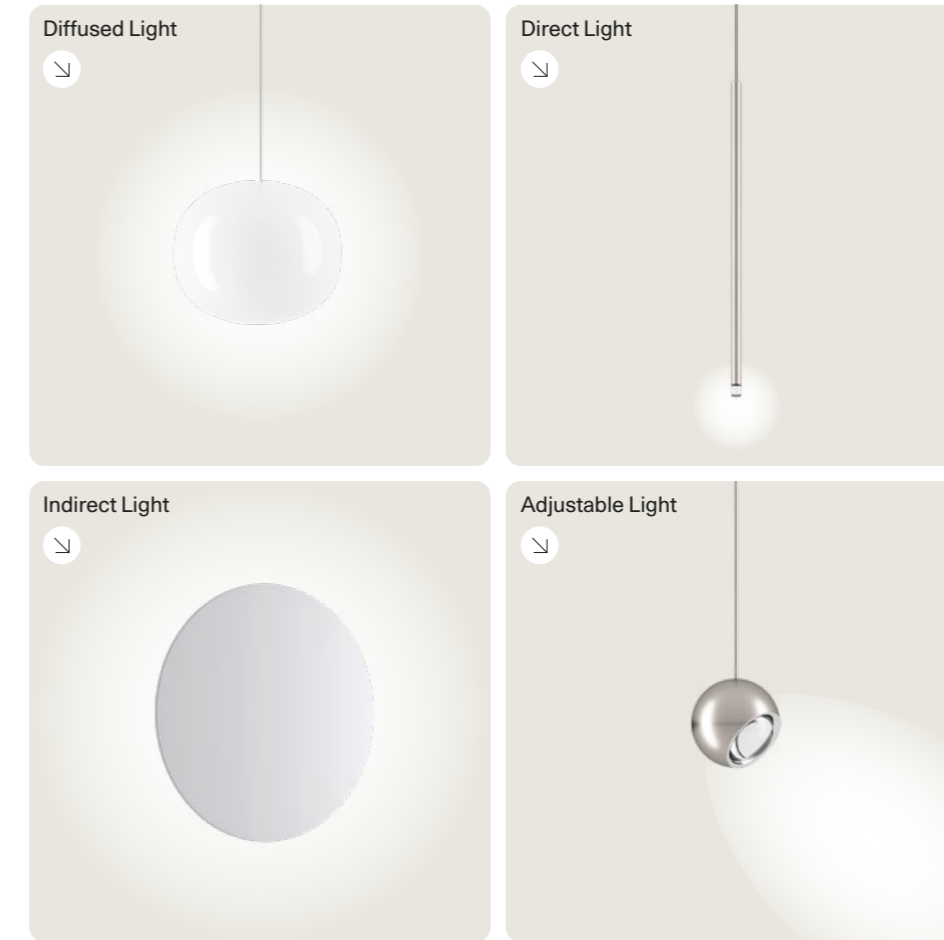

Lodes *decorates* spaces through its lighting collections and the *lighting scenes* they emit. Our products offer various *lighting effects* to create different atmospheres, from intimacy for the evening hours to concentration to work, ensuring maximum *freedom of expression* for users.

Lodes arreda e *decora* gli spazi attraverso le sue collezioni di illuminazione e le *scenografie di luce* che esse emettono. I nostri prodotti offrono vari effetti luminosi che concorrono a creare atmosfere diverse, dall'intimità per le ore serali alla concentrazione per il lavoro, per garantire la massima *libertà espressiva* agli utenti.



# Lighting relations, emotion with light.



Creating lighting solutions also means offering *control* and *personalisation* to transform rooms according to the needs of the moment.

Creare soluzioni illuminotecniche significa anche offrire *controllo* e *personalizzazione* per trasformare gli ambienti in base alle necessità del momento.

# Lodes' Design Tools for Professionals

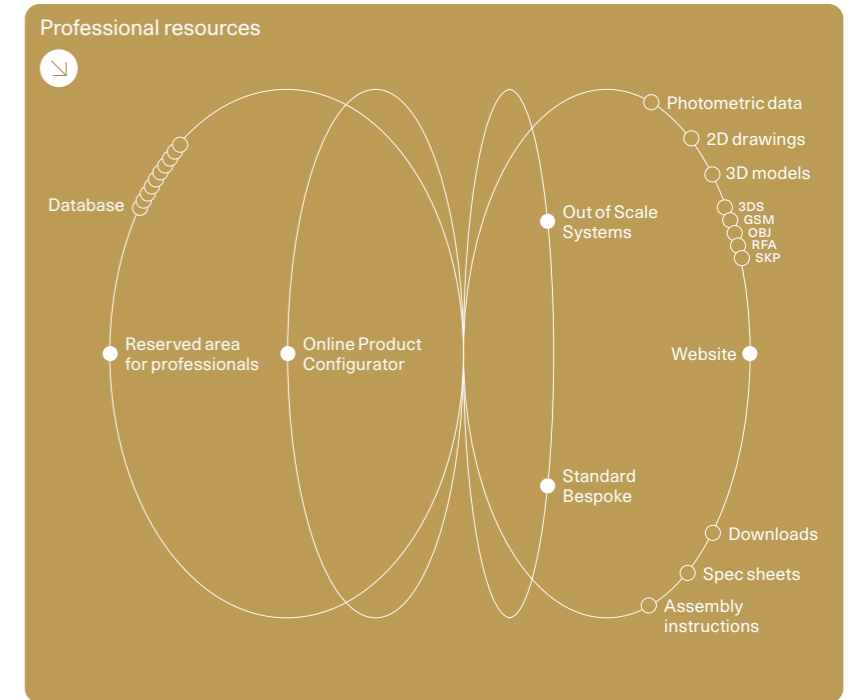

Lodes offers various tools for professional lighting design, allowing *architects* and *designers* to manage projects from concept to realisation.

Lodes offre diversi strumenti per la progettazione illuminotecnica professionale, consentendo ad *architetti* e *designer* di gestire i progetti dalla fase di ideazione alla realizzazione.

## Dimmable lamps

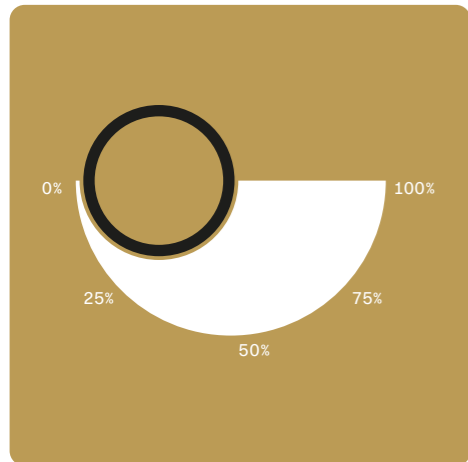

The *dimmer* function allows modulation of *light* intensity, finding the right combination between brightness and almost total darkness.

## Dimming icons

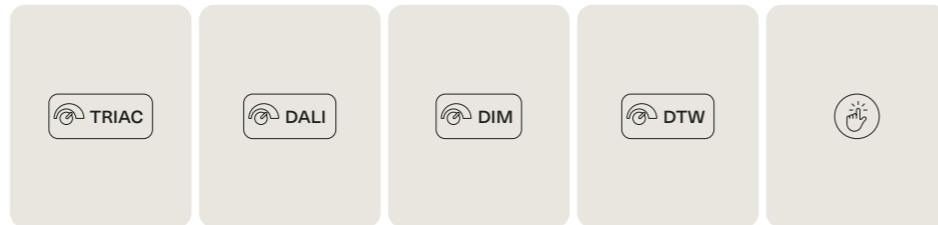

La funzione di *dimmerazione* consente di modulare l'intensità della *luce*, trovando la giusta combinazione tra la luminosità più intensa e il buio quasi totale.

## LED Sustainability and Energy Savings

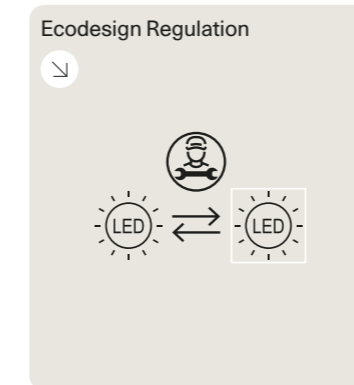

The LEDs efficiency leads to *energy savings*, extended lifespans and reduced maintenance and replacement costs.

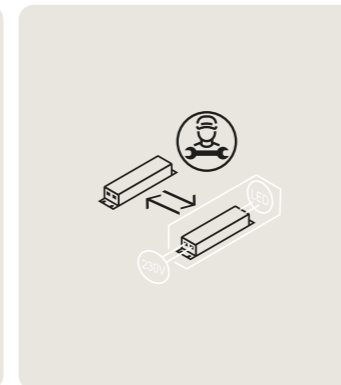

L'efficienza dei LED si traduce in *risparmio energetico* e lunga durata, con costi di manutenzione e di sostituzione ridotti.

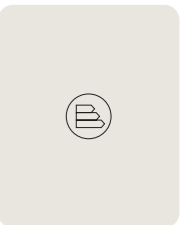

Energy Savings icon



# Ron Arad, Marco Dessí, Chia-Ying Lee, Dima Loginoff, Vittorio Massimo, Paola Navone –OTTO Studio, Needs Studio, Luca Nichetto, Patrick Norguet, Marco Piva, Snøhetta, Studio Italia Design, Andrea Tosetto, Pio & Tito Toso, YOY, Nika Zupanc.

Lodes Designer  
Visit the website



Designer A-Z

Lodes collaborates with italian and international designers and architecture studios, to shape unique lighting and decorative projects. Thanks to continuous research and experimentation, ideas take shape and the company becomes the meeting place for creative flair, technical expertise, and craftsmanship.

Lodes collabora con designer e studi di architettura italiani e internazionali per creare progetti luminosi e decorativi unici. Grazie a continue ricerche e sperimentazioni, le idee prendono forma e l'azienda diventa il luogo d'incontro tra estro creativo, esperienza tecnica e artigianalità.



Ron Arad



Marco Dessí



Chia-Ying Lee



Dima Loginoff



Vittorio Massimo



Paola Navone - OTTO Studio



Needs Studio



Luca Nichetto



Patrick Norguet



Marco Piva



Snøhetta



Studio Italia Design



Andrea Tosetto



Pio & Tito Toso



YOY



Nika Zupanc



Today, *Lodes* stands as one of Europe's foremost manufacturers of decorative lighting, operating in over 90 global markets.

Oggi *Lodes* è uno dei principali produttori europei di illuminazione decorativa, attiva in oltre 90 mercati di tutto il mondo.

[lodes.com](http://lodes.com)  
Visit the website



P.	Cluster suspension lamps
260	A-Tube
226	A-Tube Nano
250	A-Tube Nano Duo
306	Cono di Luce
270	IVY I
188	Jefferson
284	JIM
296	Kelly Cluster
174	Nostalgia
090	Oblò <b>NEW LAMP</b>
214	Rain
124	Random
104	Random Solo
198	Spider
144	Volum 14, 22, 29
318	Single canopies
322	Multiple canopies
	Suspension lamps
472	Cima
052	Elara
270	IVY V
284	JIM
076	Kelly dome
076	Kelly sphere
038	Random Cloud
020	Random Stick <b>NEW LAMP</b>
062	Sky-Fall
062	Sky-Fall Round
330	Tidal <b>NEW LAMP</b>
144	Volum 42
	Wall lamps
426	Aile
420	Laser
360	Nautilus
360	Nautilus Mini
414	Pin-Up
388	Puzzle
394	Puzzle Mega
378	Puzzle Round
350	Shift <b>NEW LAMP</b>
144	Volum

P.	Ceiling lamps
260	A-Tube
226	A-Tube Nano Swing <b>NEW LAMP</b>
406	Bugia
360	Nautilus
360	Nautilus Spot
414	Pin-Up
388	Puzzle
394	Puzzle Mega
378	Puzzle Round
198	Spider
330	Tidal 60
330	Tidal 45, 75 <b>NEW LAMP</b>
144	Volum
	Floor lamps
472	Cima
458	Croma
464	Flar
434	Hover
144	Volum <b>NEW LAMP</b>
	Table lamps
444	Blow
306	Cono di Luce
450	Easy Peasy
464	Flar
434	Hover
144	Volum
	Focus
088	Standard Bespoke
328	Out of Scale
432	Customised Lighting Solutions

480	Glossary
482	Ecodesign Regulation
483	DALI/PUSH to TRIAC Signal Converter
484	Extended dimming solutions
485	Light sources power

LODES INTERACTIVE CATALOG  
Click on the name of the lamp to go directly to the corresponding chapter.

Clicca sul nome della lampada per accedere direttamente al capitolo corrispondente.





## Cluster suspension lamps

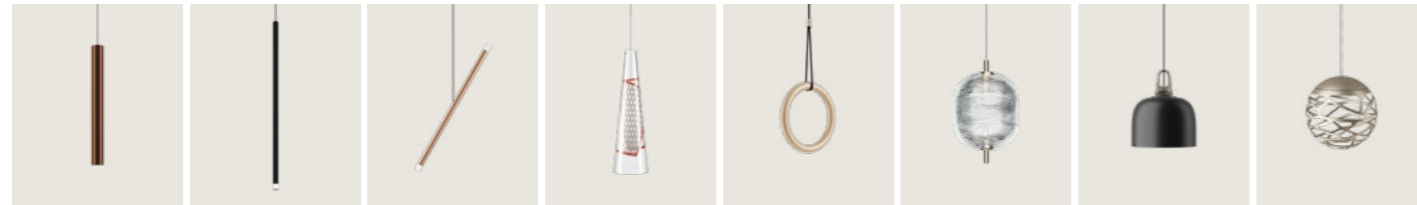

A-Tube P. 260   A-Tube Nano P. 226   A-Tube Nano Duo P. 250   Cono di Luce P. 306   IVYI P. 270   Jefferson P. 188   JIM P. 284   Kelly Cluster P. 296



Nostalgia P. 174   Oblò P. 090   Rain P. 214   Random P. 124   Random Solo P. 104   Spider P. 198   Volum P. 144

## Suspension lamps

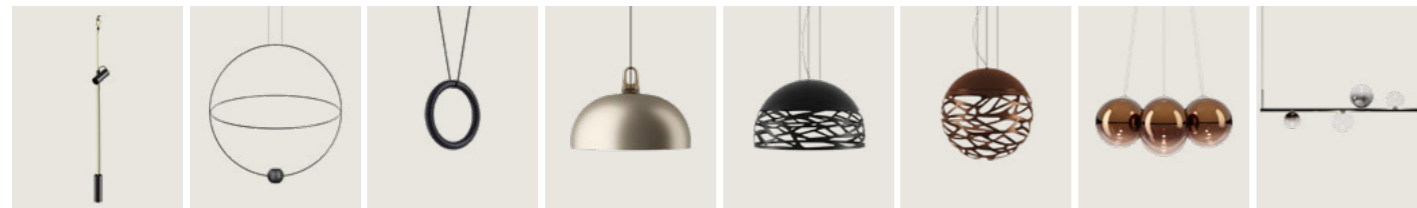

Cima P. 472   Elara P. 052   IVYV P. 270   JIM P. 284   Kelly dome P. 076   Kelly sphere P. 076   Random Cloud P. 038   Random Stick P. 020

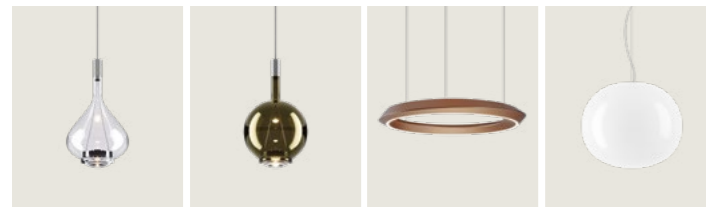

Sky-Fall P. 062   Sky-Fall Round P. 062   Tidal P. 330   Volum P. 144

## Wall lamps

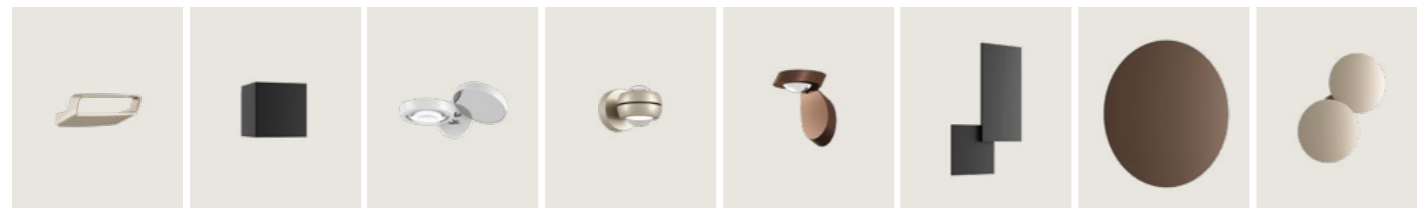

Aile P. 426   Laser P. 420   Nautilus P. 360   Nautilus Mini P. 360   Pin-Up P. 414   Puzzle P. 388   Puzzle Mega P. 394   Puzzle Round P. 378



Shift P. 350   Volum P. 144

## Ceiling lamps



A-Tube P. 260   A-Tube Nano Swing P. 226   Bugia P. 406   Nautilus P. 360   Nautilus Spot P. 360   Pin-Up P. 414   Puzzle P. 388   Puzzle Mega P. 394



Puzzle Round P. 378   Spider P. 198   Tidal P. 330   Volum P. 144

## Floor lamps

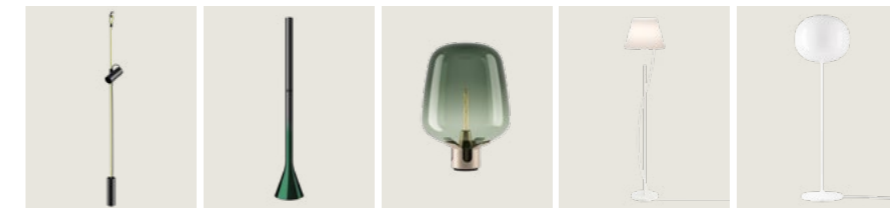

Cima P. 472   Cromia P. 458   Flar P. 464   Hover P. 434   Volum P. 144

## Table lamps

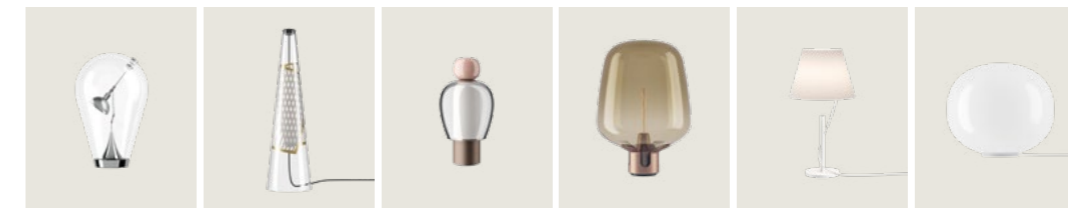

Blow P. 444   Cono di Luce P. 306   Easy Peasy P. 450   Flar P. 464   Hover P. 434   Volum P. 144

LODES INTERACTIVE CATALOG  
 Click on the index to explore the catalog. To return to this page, simply click the **BACK TO INDEX** button at the top right.

Clicca sull'indice per esplorare il catalogo. Per tornare a questa pagina, basta cliccare sul pulsante **BACK TO INDEX** in alto a destra.





# Random Stick

Designed by Chia-Ying Lee

Year 2024

*Random Stick* extends the collection of the same name designed by Chia-Ying Lee with a stand-alone suspension lamp that has an essential yet highly decorative character. *Random's* poetic spheres of light find their place on a hexagonal bar, reminiscent of fragile soap bubbles skimming the surface before taking flight again. The lamp, available in two bar lengths – 100 cm and 150 cm – lends itself to illuminating long, rectangular surfaces of various sizes, such as a dining table or a cocktail bar counter. The spheres pick up on *Random's* seven finishes, freely combinable on polished gold, polished black, and matt white bars to create original colour combinations and luminous effects. The decorative function of the spheres is further enhanced by LED modules at the bottom of the bar, complementing the light already diffused by the spheres and ensuring uniform downward brightness.

*Random Stick* amplia l'omonima collezione firmata da Chia-Ying Lee con una lampada a sospensione stand-alone dal carattere essenziale, ma fortemente decorativo. Le poetiche sfere di luce di *Random* trovano posto su una barra esagonale, quasi come fossero fragili bolle di sapone che ne sfiorano la superficie prima di riprendere il volo. La lampada, disponibile in due lunghezze di barra, da 100 cm e 150 cm, si presta a illuminare superfici lunghe e rettangolari di diverse dimensioni, come un tavolo da pranzo o il bancone di un cocktail bar. Le sfere riprendono le sette finiture di *Random*, liberamente abbinabili su barre di colore oro lucido, nero lucido e bianco opaco per creare originali accostamenti cromatici ed effetti luminosi. La funzione decorativa delle sfere viene ulteriormente accentuata grazie ai moduli LED nella parte inferiore della barra: ciò completa la luce già diffusa dalle sfere e garantisce una luminosità uniforme verso il basso.



Go to the technical info [+](#)

Click to discover more [↓](#)

Random Stick  
COD. 234

CATEGORY LAMP

Suspension      Sospensione

TYPE OF LIGHT

Diffused light      Luce diffusa  
Symmetrical diffused light      Luce simmetrica diffusa



NEW LAMP

















028 Random Stick short, FINISHES Glossy Smoke, Clear and Chrome – Structure Glossy Gold.



Random Stick, FINISH Clear – Structure Glossy Gold.

*Random Stick* élargit la collection du même nom conçue par Chia-Ying Lee avec une suspension stand-alone au caractère essentiel mais fortement décoratif. Les sphères de lumière poétiques de *Random* reposent sur une barre hexagonale, faisant penser à de fragiles bulles de savon qui effleurent la surface avant de s'envoler. La suspension, disponible en deux longueurs de barre de 100 cm et 150 cm, éclaire des surfaces longues et rectangulaires de différentes tailles, comme une table à manger ou le comptoir d'un cocktail bar. Les sphères rappellent les sept finitions de *Random*, à combiner librement sur des barres de couleur or brillant, noir brillant et blanc mat pour créer d'originales combinaisons de couleurs et d'effets de lumière. La fonction décorative des sphères est encore plus accentuée grâce aux modules LED installés dans la partie inférieure de la barre : ils complètent la lumière déjà diffusée par les sphères et garantissent une luminosité uniforme vers le bas. ●FR

*Random Stick* erweitert die von Chia-Ying Lee entworfene gleichnamige Kollektion um eine eigenständige Hängeleuchte mit essentiellen, aber sehr dekorativem Charakter. Die poetischen Lichtkugeln von *Random* finden ihren Platz auf einem sechseckigen Stab, als wären sie zerbrechliche Seifenblasen, die die Oberfläche kurz berühren, um anschließend wieder in die Luft aufzusteigen. Die Leuchte, die in zwei Stablängen – 100 cm und 150 cm – erhältlich ist, eignet sich zur Beleuchtung von langen, rechteckigen Flächen unterschiedlicher Größe, wie z. B. einem Esstisch oder einer Cocktailbar-Theke. Die Kugeln greifen die sieben Ausführungen von *Random* auf, die auf glänzend goldenen, glänzend schwarzen und mattweißen Stäben frei kombiniert werden können, um originelle Farbkombinationen und leuchtende Effekte zu erzielen. Die dekorative Funktion der Kugeln wird durch die LED-Module am unteren Ende des Stabes noch verstärkt: dies ergänzt das bereits von den Kugeln verbreitete Licht und sorgt für eine gleichmäßige Leuchtkraft nach unten. ●DE

*Random Stick* amplía la colección del mismo nombre firmada por Chia-Ying Lee con una lámpara de suspensión stand alone con un carácter esencial y muy decorativo. Las poéticas esferas de luz de *Random* tienen cabida en una barra hexagonal, prácticamente como si fueran frágiles pompas de jabón que rozan la superficie antes de reanudar el vuelo. La lámpara, disponible con la barra de dos longitudes distintas – de 100 cm y 150 cm, se presta a iluminar superficies largas y rectangulares de distintos tamaños, como una mesa de comedor o la barra de una coctelería. Las esferas retoman los siete acabados de *Random* que pueden combinarse libremente en barras de color dorado brillante, negro brillante y blanco mate para crear originales combinaciones cromáticas y efectos de iluminación. La función decorativa de las esferas la acentúan aún más los módulos LED de la parte inferior de la barra: esto completa la luz que ya proyectan las esferas y garantiza una luminosidad uniforme hacia abajo. ●ES

*Random Stick* расширяет одноименную коллекцию, разработанную Чиа-Ин Ли, отдельным подвесным светильником, обладающим простотой, и, одновременно, выраженной декоративностью. Поэтические световые сферы *Random* крепятся на шестигранный стержень, как хрупкие мыльные пузыри, легко дотрагивающиеся до поверхности перед тем, как улететь в небо. Лампа, выпускаемая с двумя вариантами длины стержня, 100 см и 150 см, подходит для освещения длинных и прямоугольных поверхностей разных размеров, таких как обеденный стол или стойка коктейльбара. Сферы повторяют семь вариантов отделки *Random*, которые можно свободно сочетать на блестящих золотых, блестящих черных и матовых белых стержнях для создания оригинальных хроматических сочетаний и световых эффектов. Декоративная функция сфер дополнительно подчеркивается светодиодными модулями в нижней части стержня: они дополняют свет, рассеиваемый сферами, и гарантируют равномерную яркость излучения в направлении вниз. ●RU

*Random Stick* 以一款特征朴素但具有高度装饰性的独立悬吊灯扩展了由李佳颖设计的同名系列。*Random*那富有诗意的灯球位于一条六角形条杆上,几乎就像脆弱的肥皂泡一样于再次飞起之前掠过表面。这款灯品提供100厘米和150厘米这两种可选长度,适合照亮不同尺寸的长形和矩形表面,例如餐桌或鸡尾酒吧的吧台。球体再现*Random*的七种饰面,可在亮金色、亮黑色和哑光白色条杆上自由搭配,以创建原创性的色彩组合和灯光效果。条杆下部的LED模块进一步彰显了球体的装饰功能:这补充了已由球体扩散的光线且保证了朝向下方的均匀亮度。●ZH

#### Random Stick short » Suspension lamp NEW LAMP

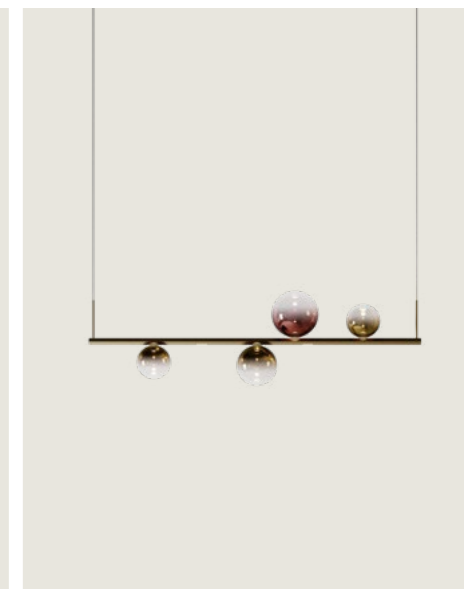
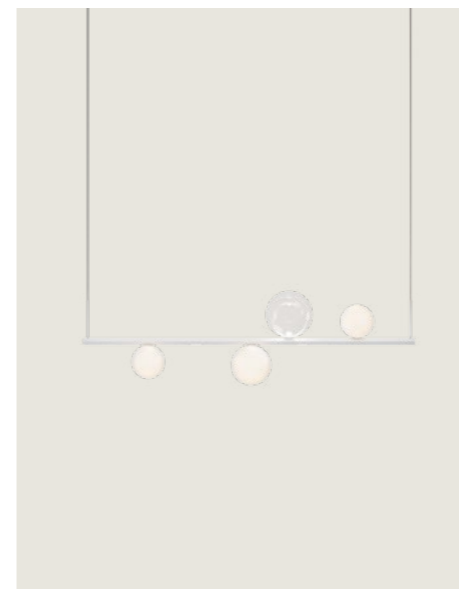

#### Random Stick long » Suspension lamp NEW LAMP

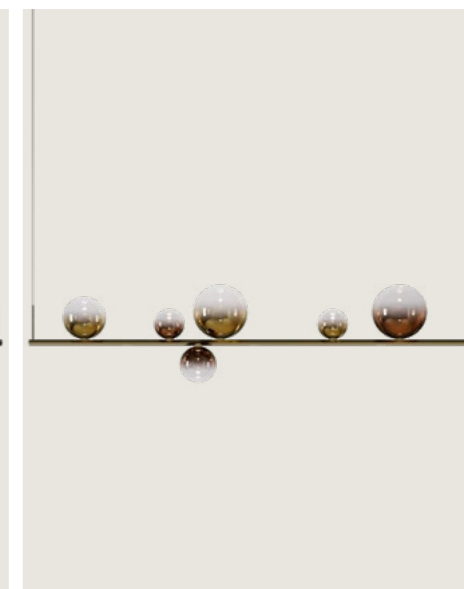
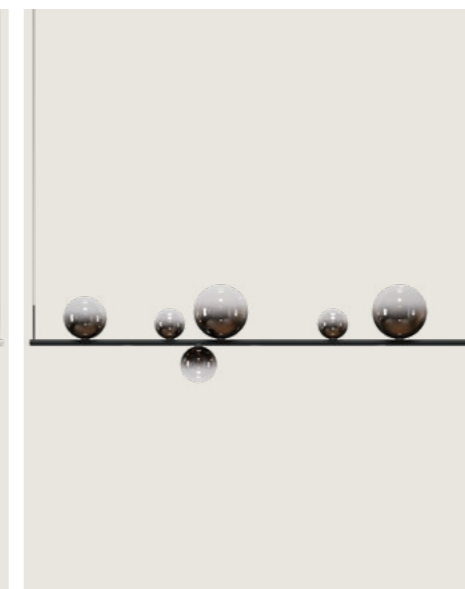
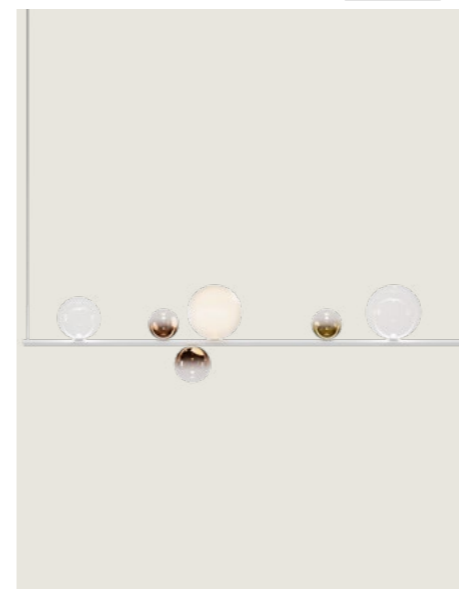



# Random Stick short

Description Descrizione	Dimensions Dimensioni	
Metal structure Montatura in metallo	100 cm 39,37"	①
Blown glass sphere Sfera in vetro soffiato	Ø 10 cm Ø 3,93"	②
Blown glass sphere Sfera in vetro soffiato	Ø 12 cm Ø 4,72"	③
Blown glass sphere Sfera in vetro soffiato	Ø 14 cm Ø 5,51"	④
Blown glass sphere Sfera in vetro soffiato	Ø 10 cm Ø 3,93"	⑤

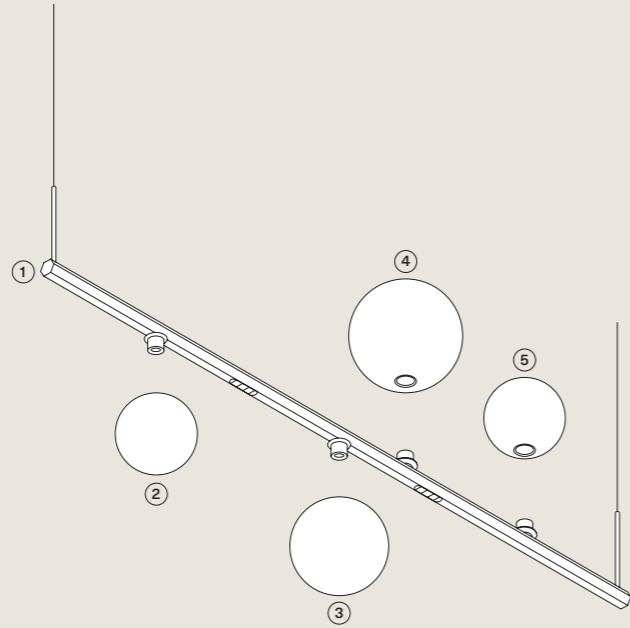

Net weight Peso netto	1,83 kg 4,03 lbs	Pack Colli	5	Energy class Classe energetica	D
--------------------------	---------------------	---------------	---	-----------------------------------	---

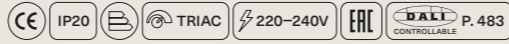

For the product coding, see table ► P. 036  
Per la codifica del prodotto, consultare la tabella ► P. 036

## Random Stick short

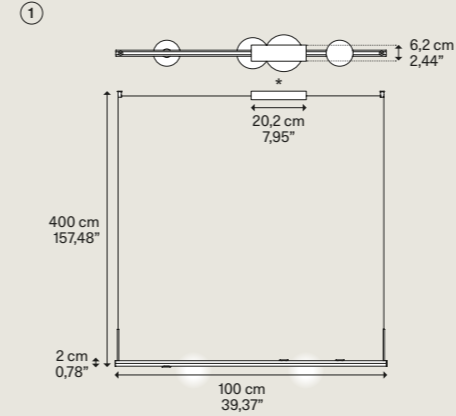

\* Adjustable canopy position  
\* Posizione del rosone regolabile

Metal structure Montatura in metallo		Code Codice	A	Code Codice	B
I Extra Matte White	Bianco Extra Opaco	23420M 1027		23420M 1030	
II Black Chrome	Cromo Nero	23420M 2227		23420M 2230	
III Glossy Gold	Oro Lucido	23420M 5027		23420M 5030	



Light source Sorgente luminosa	A
LED	K
2700	
3x 2 W + 4x 1 W	
1500	lm
Diffused light	600 lm
Direct light	900 lm
350	mA
CRI 90	
MacAdam 3-Step	
LED and driver included LED e driver inclusi	

Light source Sorgente luminosa	B
LED	K
3000	
3x 2 W + 4x 1 W	
1600	lm
Diffused light	640 lm
Direct light	960 lm
350	mA
CRI 90	
MacAdam 3-Step	
LED and driver included LED e driver inclusi	

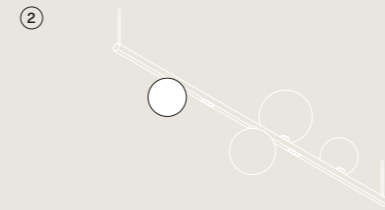

Description Descrizione	Blown glass diffuser Diffusore in vetro soffiato	Code Codice	
Blown glass sphere Ø 10 cm/3,93"	IV Clear	Trasparente	17110V 00
Sfera in vetro soffiato Ø 10 cm/3,93"	V Frosted White	Bianco Satinato	17110V 13
	VI Chrome	Cromo	17110V 40
	VII Glossy Smoke	Fumo Lucido	17110V 43
	VIII Glossy Bronze	Bronzo Lucido	17110V 46
	IX Gold	Oro	17110V 50
	X Rose Gold	Oro Rosa	17110V 55

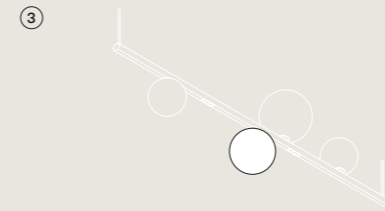
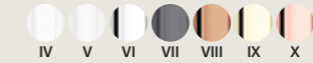

Description Descrizione	Blown glass diffuser Diffusore in vetro soffiato	Code Codice	
Blown glass sphere Ø 12 cm/4,72"	IV Clear	Trasparente	17111V 00
Sfera in vetro soffiato Ø 12 cm/4,72"	V Frosted White	Bianco Satinato	17111V 13
	VI Chrome	Cromo	17111V 40
	VII Glossy Smoke	Fumo Lucido	17111V 43
	VIII Glossy Bronze	Bronzo Lucido	17111V 46
	IX Gold	Oro	17111V 50
	X Rose Gold	Oro Rosa	17111V 55

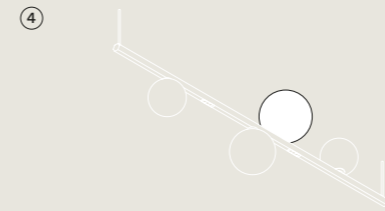
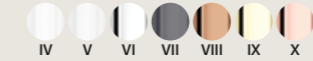

Description Descrizione	Blown glass diffuser Diffusore in vetro soffiato	Code Codice	
Blown glass sphere Ø 14 cm/5,51"	IV Clear	Trasparente	17112V 00
Sfera in vetro soffiato Ø 14 cm/5,51"	V Frosted White	Bianco Satinato	17112V 13
	VI Chrome	Cromo	17112V 40
	VII Glossy Smoke	Fumo Lucido	17112V 43
	VIII Glossy Bronze	Bronzo Lucido	17112V 46
	IX Gold	Oro	17112V 50
	X Rose Gold	Oro Rosa	17112V 55

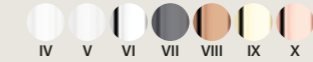

Description Descrizione	Blown glass diffuser Diffusore in vetro soffiato	Code Codice	
Blown glass sphere Ø 10 cm/3,93"	IV Clear	Trasparente	17110V 00
Sfera in vetro soffiato Ø 10 cm/3,93"	V Frosted White	Bianco Satinato	17110V 13
	VI Chrome	Cromo	17110V 40
	VII Glossy Smoke	Fumo Lucido	17110V 43
	VIII Glossy Bronze	Bronzo Lucido	17110V 46
	IX Gold	Oro	17110V 50
	X Rose Gold	Oro Rosa	17110V 55



# Random Stick long

Description Descrizione	Dimensions Dimensioni	
Metal structure Montatura in metallo	150 cm 59,05"	①
Blown glass sphere Sfera in vetro soffiato	Ø 14 cm Ø 5,51"	②
Blown glass sphere Sfera in vetro soffiato	Ø 10 cm Ø 3,93"	③
Blown glass sphere Sfera in vetro soffiato	Ø 12 cm Ø 4,72"	④
Blown glass sphere Sfera in vetro soffiato	Ø 18 cm Ø 7,08"	⑤
Blown glass sphere Sfera in vetro soffiato	Ø 10 cm Ø 3,93"	⑥
Blown glass sphere Sfera in vetro soffiato	Ø 18 cm Ø 7,08"	⑦

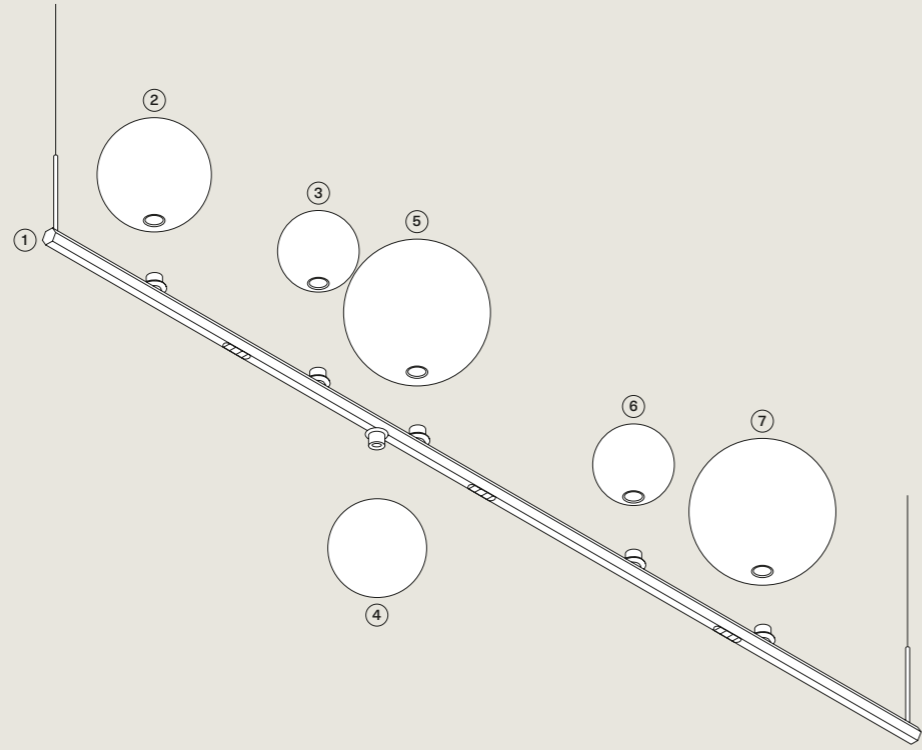

Net weight Peso netto	2,84 kg 6,26 lbs	Pack Colli	7	Energy class Classe energetica	D
--------------------------	---------------------	---------------	---	-----------------------------------	---

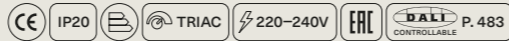

For the product coding, see table ► P. 037  
Per la codifica del prodotto, consultare la tabella ► P. 037

## Random Stick long

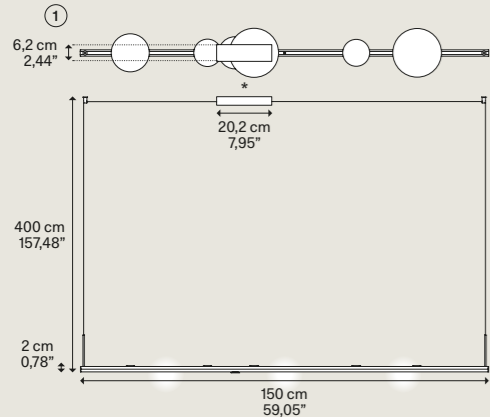

Metal structure Montatura in metallo		Code Codice	A	Code Codice	B
I Extra Matte White	Bianco Extra Opaco	23421M 1027		23421M 1030	
II Black Chrome	Cromo Nero	23421M 2227		23421M 2230	
III Glossy Gold	Oro Lucido	23421M 5027		23421M 5030	



Light source Sorgente luminosa	A
LED 2700 K 3x 3 W + 6x 1 W 2250 lm Diffused light ≈ 900 lm Direct light ≈ 1350 lm 350 mA CRI 90 MacAdam 3-Step	

Light source Sorgente luminosa	B
LED 3000 K 3x 3 W + 6x 1 W 2400 lm Diffused light ≈ 980 lm Direct light ≈ 1720 lm 350 mA CRI 90 MacAdam 3-Step	

LED and driver included  
LED e driver inclusi

LED and driver included  
LED e driver inclusi

\* Adjustable canopy position  
\* Posizione del rosone regolabile

## Random Stick long

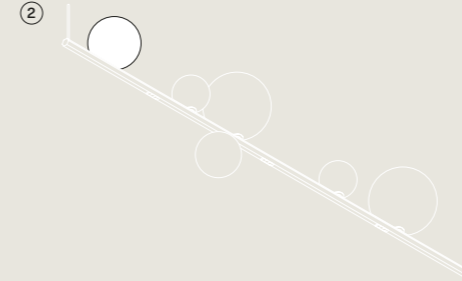

Description Descrizione	Blown glass diffuser Diffusore in vetro soffiato	Code Codice
Blown glass sphere Ø 14 cm/5,51" Sfera in vetro soffiato Ø 14 cm/5,51"	IV Clear Trasparente	17112V 00
	V Frosted White Bianco Satinato	17112V 13
	VI Chrome Cromo	17112V 40
	VII Glossy Smoke Fumo Lucido	17112V 43
	VIII Glossy Bronze Bronzo Lucido	17112V 46
	IX Gold Oro	17112V 50
	X Rose Gold Oro Rosa	17112V 55

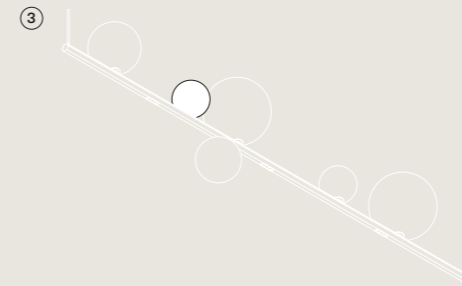

Description Descrizione	Blown glass diffuser Diffusore in vetro soffiato	Code Codice
Blown glass sphere Ø 10 cm/3,93" Sfera in vetro soffiato Ø 10 cm/3,93"	IV Clear Trasparente	17110V 00
	V Frosted White Bianco Satinato	17110V 13
	VI Chrome Cromo	17110V 40
	VII Glossy Smoke Fumo Lucido	17110V 43
	VIII Glossy Bronze Bronzo Lucido	17110V 46
	IX Gold Oro	17110V 50
	X Rose Gold Oro Rosa	17110V 55

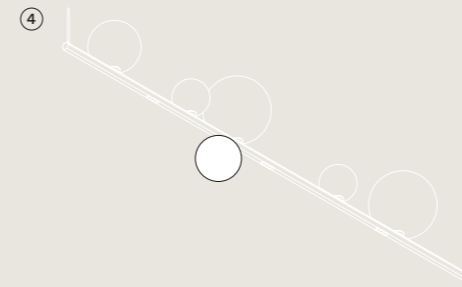
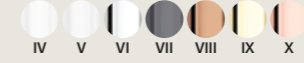

Description Descrizione	Blown glass diffuser Diffusore in vetro soffiato	Code Codice
Blown glass sphere Ø 12 cm/4,72" Sfera in vetro soffiato Ø 12 cm/4,72"	IV Clear Trasparente	17111V 00
	V Frosted White Bianco Satinato	17111V 13
	VI Chrome Cromo	17111V 40
	VII Glossy Smoke Fumo Lucido	17111V 43
	VIII Glossy Bronze Bronzo Lucido	17111V 46
	IX Gold Oro	17111V 50
	X Rose Gold Oro Rosa	17111V 55

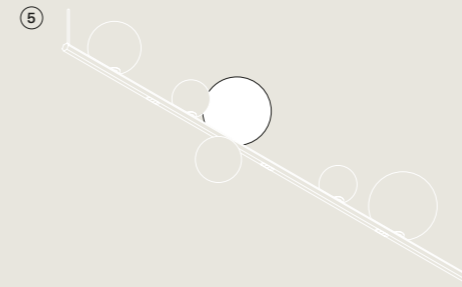

Description Descrizione	Blown glass diffuser Diffusore in vetro soffiato	Code Codice
Blown glass sphere Ø 18 cm/7,08" Sfera in vetro soffiato Ø 18 cm/7,08"	IV Clear Trasparente	17113V 00
	V Frosted White Bianco Satinato	17113V 13
	VI Chrome Cromo	17113V 40
	VII Glossy Smoke Fumo Lucido	17113V 43
	VIII Glossy Bronze Bronzo Lucido	17113V 46
	IX Gold Oro	17113V 50
	X Rose Gold Oro Rosa	17113V 55

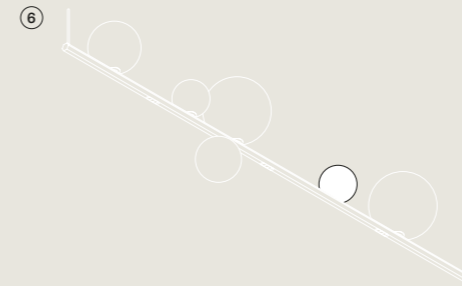
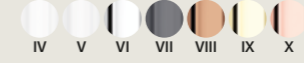

Description Descrizione	Blown glass diffuser Diffusore in vetro soffiato	Code Codice
Blown glass sphere Ø 10 cm/3,93" Sfera in vetro soffiato Ø 10 cm/3,93"	IV Clear Trasparente	17110V 00
	V Frosted White Bianco Satinato	17110V 13
	VI Chrome Cromo	17110V 40
	VII Glossy Smoke Fumo Lucido	17110V 43
	VIII Glossy Bronze Bronzo Lucido	17110V 46
	IX Gold Oro	17110V 50
	X Rose Gold Oro Rosa	17110V 55



Description Descrizione	Blown glass diffuser Diffusore in vetro soffiato	Code Codice
Blown glass sphere Ø 18 cm/7,08" Sfera in vetro soffiato Ø 18 cm/7,08"	IV Clear Trasparente	17113V 00
	V Frosted White Bianco Satinato	17113V 13
	VI Chrome Cromo	17113V 40
	VII Glossy Smoke Fumo Lucido	17113V 43
	VIII Glossy Bronze Bronzo Lucido	17113V 46
	IX Gold Oro	17113V 50
	X Rose Gold Oro Rosa	17113V 55





Random Stick short

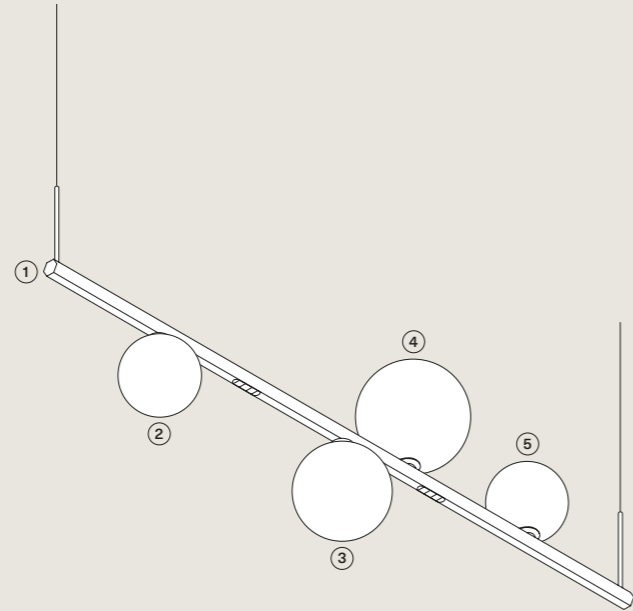

Create the product code  
Crea il codice prodotto

Structure 100		Sphere 10	Sphere 12	Sphere 14	Sphere 10							
2700 K	3000 K											
I	23420M 1027	23420M 1030	IV	17110V 00	17111V 00	17112V 00	17110V 00					
			V	17110V 13	17111V 13	17112V 13	17110V 13					
II	23420M 2227	23420M 2230	VI	17110V 40	17111V 40	17112V 40	17110V 40					
			VII	17110V 43	17111V 43	17112V 43	17110V 43					
III	23420M 5027	23420M 5030	VIII	17110V 46	17111V 46	17112V 46	17110V 46					
			IX	17110V 50	17111V 50	17112V 50	17110V 50					
			X	17110V 55	17111V 55	17112V 55	17110V 55					
				②	③	④	⑤					
				23420M ____	+	17110V __	+	17111V __	+	17112V __	+	17110V __

I	Extra Matte White	Bianco Extra Opaco	VI	Chrome	Cromo
II	Black Chrome	Cromo Nero	VII	Glossy Smoke	Fumo Lucido
III	Glossy Gold	Oro Lucido	VIII	Glossy Bronze	Bronzo Lucido
IV	Clear	Trasparente	IX	Gold	Oro
V	Frosted White	Bianco Satinato	X	Rose Gold	Oro Rosa

Random Stick long

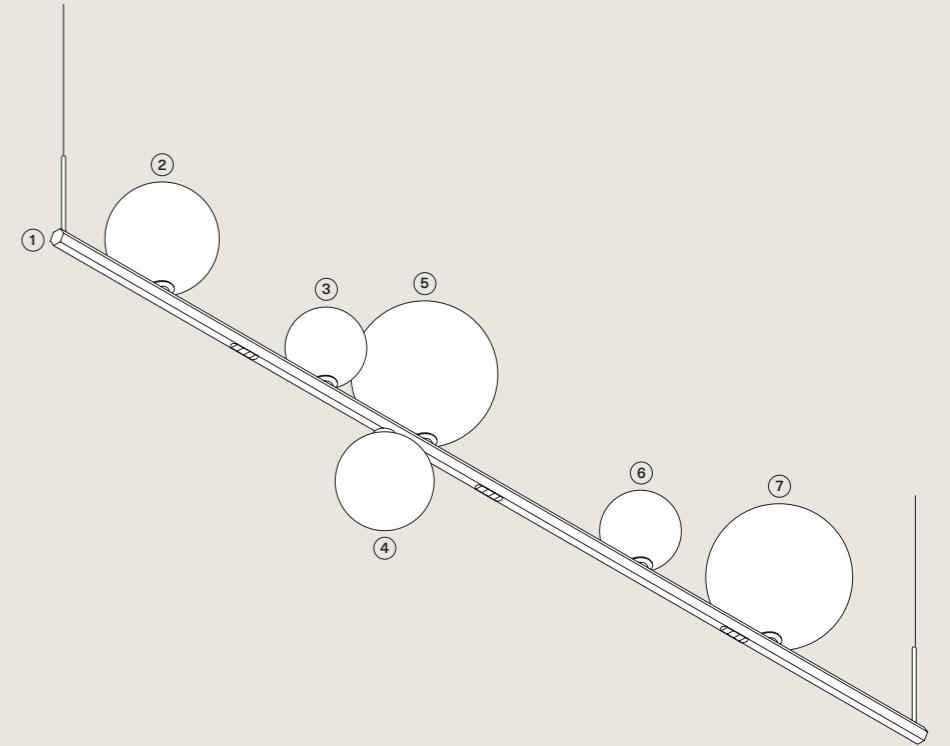

Create the product code  
Crea il codice prodotto

Structure 150		Sphere 14	Sphere 10	Sphere 12	Sphere 18	Sphere 10	Sphere 18									
2700 K	3000 K															
I	23421M 1027	23421M 1030	IV	17112V 00	17110V 00	17111V 00	17113V 00									
			V	17112V 13	17110V 13	17111V 13	17113V 13									
II	23421M 2227	23421M 2230	VI	17112V 40	17110V 40	17111V 40	17113V 40									
			VII	17112V 43	17110V 43	17111V 43	17113V 43									
III	23421M 5027	23421M 5030	VIII	17112V 46	17110V 46	17111V 46	17113V 46									
			IX	17112V 50	17110V 50	17111V 50	17113V 50									
			X	17112V 55	17110V 55	17111V 55	17113V 55									
				②	③	④	⑤									
				⑥	⑦											
				23421M ____	+	17112V __	+	17110V __	+	17111V __	+	17113V __	+	17110V __	+	17113V __

I	Extra Matte White	Bianco Extra Opaco	VI	Chrome	Cromo
II	Black Chrome	Cromo Nero	VII	Glossy Smoke	Fumo Lucido
III	Glossy Gold	Oro Lucido	VIII	Glossy Bronze	Bronzo Lucido
IV	Clear	Trasparente	IX	Gold	Oro
V	Frosted White	Bianco Satinato	X	Rose Gold	Oro Rosa

# Random Cloud

Designed by Chia-Ying Lee

Year 2024

*Random Cloud* is a stand-alone suspension lamp that reinvents the concept of the contemporary chandelier by creating evocative luminous clouds. Developed as a natural evolution of *Random Solo*, it combines multiple spheres – 7, 14, 19 or 23, with diameters of 23 or 28 cm – with a central canopy from which thin cables are cut to precise lengths, achieving the effect of a cloud of bubbles suspended in the air, voluminous and light. *Random Cloud* is monochrome and available in seven refined finishes, offering lighting and decorative solutions suitable for a wide range of environments, from domestic spaces to Food & Beverage, as well as contract and retail.

*Random Cloud* è una lampada a sospensione stand-alone che reinventa il concetto di chandelier contemporaneo creando suggestive nuvole luminose. Nata come naturale evoluzione di *Random Solo*, unisce più sfere – 7, 14, 19 o 23 da 23 o 28 cm di diametro – a un rosone centrale dal quale partono sottili cavi tagliati a lunghezze precise per ottenere proprio l'effetto di una nuvola di bolle sospesa nell'aria, voluminosa e leggera. *Random Cloud* è monocromatica e disponibile in sette raffinate finiture per offrire soluzioni luminose e decorative adatte a una vasta gamma di ambienti, da quelli domestici al Food & Beverage, fino al contract e al retail.



Go to the technical info [+](#) Click to discover more [↓](#)

Random Cloud COD. 221	CATEGORY LAMP		TYPE OF LIGHT	
	Suspension	Sospensione	Diffused light	Luce diffusa







Random Cloud 14 Lights Ø23, FINISH Frosted White.









*Random Cloud* est une suspension stand-alone qui réinvente le concept du lustre contemporain en créant des nuages lumineux suggestifs. Née comme une évolution spontanée de *Random Solo*, elle combine plusieurs sphères – 7, 14, 19 ou 23 de 23 ou 28 cm – avec une patère centrale d'où partent de fins câbles coupés à des longueurs précises pour obtenir l'effet d'un nuage de bulles suspendues dans l'air, volumineux et léger. *Random Cloud* est monochromatique et se propose en sept finitions raffinées pour offrir des solutions lumineuses et décoratives adaptées à un large éventail de milieux, qu'ils soient privés ou Food & Beverage, contract ou vente au détail. ●FR

*Random Cloud* ist eine Stand-Alone Hängeleuchte, die das Konzept des zeitgenössischen Kronleuchters durch die Kreation suggestiver Lichtwolken neu erfindet. Entstanden aus der natürlichen Evolution von *Random Solo*, vereint sie mehrere Kugeln – 7, 14, 19 oder 23 mit 23 oder 28 cm Durchmesser – mit einem zentralen Baldachin, von dem aus dünne auf eine präzise Länge geschnittene Kabel wegführen, um genau den Effekt einer in der Luft schwebenden Wolke aus Luftblasen zu erzielen, voluminös und leicht. *Random Cloud* ist monochromatisch und in sieben raffinierten Ausführungen erhältlich, um Beleuchtungs- und Dekorationslösungen zu bieten, die sich für eine Vielzahl von Ambiente eignen, von Wohnbereichen über Food & Beverage bis hin zum Contract und Einzelhandel. ●DE

*Random Cloud* es una lámpara de suspensión stand alone que reinventa el concepto de chandelier contemporáneo creando evocadoras nubes luminosas. Creada como una evolución natural de *Random Solo*, combina varias esferas – 7, 14, 19 o 23 de 23 o 28 cm de diámetro – con un florón central del que salen finos cables cortados a longitudes precisas para conseguir precisamente el efecto de una nube de burbujas suspendida en el aire, voluminosa y ligera. *Random Cloud* es monocromática y está disponible en siete refinados acabados para ofrecer soluciones luminosas y decorativas adecuadas para una amplia gama de entornos, de los domésticos al de la alimentación y bebidas, pasando por el contract y el minorista. ●ES

*Random Cloud* – это отдельно расположенный подвесной светильник, который заново изобретает концепцию современной люстры, создавая эффектные светящиеся облака. Возникший как естественная эволюция *Random Solo*, этот светильник объединяет в себе несколько сфер – 7, 14, 19 или 23 диаметром 23 или 28 см – с центральным креплением, от которого отходят тонкие кабели, отрезанные до определенной длины, позволяющей получить эффект облака из объемных и легких пузырьков, парящих в воздухе. Монохромный *Random Cloud* выпускается в семи изысканных вариантах отделки, предлагая яркие и декоративные решения, подходящие для широкого спектра помещений, как домашних, так и кафе и ресторанов, гостиниц и магазинов. ●RU

*Random Cloud* 是一款独立式悬吊灯，通过创造引人入胜的发光云朵重塑当代枝形吊灯的理念。诞生于 *Random Solo* 的自然演变，它结合了多个球体 – 7个、14个、19个或23个直径为23或28厘米的球体 – 以及一个中央底座。被切割为精确长度的细缆从底座延伸而出，以获得一朵泡泡云悬浮于空中的效果，体积大但重量轻。*Random Cloud* 是单色的，但有七种精致饰面可供选择。从居家到餐饮场所，再到定制空间和零售店，可提供适合各种环境的照明装饰性解决方案。●ZH

Random Cloud  
↳ Suspension lamp



All variants of Random Cloud are available in the following finishes  
Tutte le varianti di Random Cloud sono disponibili nelle seguenti finiture





CATEGORY SUSPENSION LAMP

DESIGN Chia-Ying Lee, 2024

Random Cloud 7 Lights Ø23

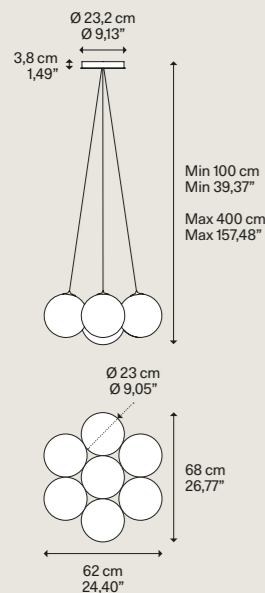

Blown glass diffuser Diffusore in vetro soffiato
Clear Trasparente
Frosted White Bianco Satinato
Chrome Cromo
Glossy Smoke Fumo Lucido
Glossy Bronze Bronzo Lucido
Gold Oro
Rose Gold Oro Rosa

Metal canopy Rosone in metallo
Matte White - 9010 Bianco Opaco - 9010

Code Codice	A	Code Codice	B
22121 0027		22121 0030	
22121 1327		22121 1330	
22121 4027		22121 4030	
22121 4327		22121 4330	
22121 4627		22121 4630	
22121 5027		22121 5030	
22121 5527		22121 5530	

Light source Sorgente luminosa	A
LED	
2700	K
7x 3	W
3150	lm
350	mA
CRI 90	
MacAdam 3-Step	
LED and driver included LED e driver inclusi	

Light source Sorgente luminosa	B
LED	
3000	K
7x 3	W
3360	lm
350	mA
CRI 90	
MacAdam 3-Step	
LED and driver included LED e driver inclusi	

Net weight Peso netto	5,20 kg 11,46 lbs	Pack Colli	15	Energy class Classe energetica	D
--------------------------	----------------------	---------------	----	-----------------------------------	---

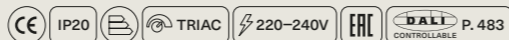

CATEGORY SUSPENSION LAMP

DESIGN Chia-Ying Lee, 2024

Random Cloud 14 Lights Ø23

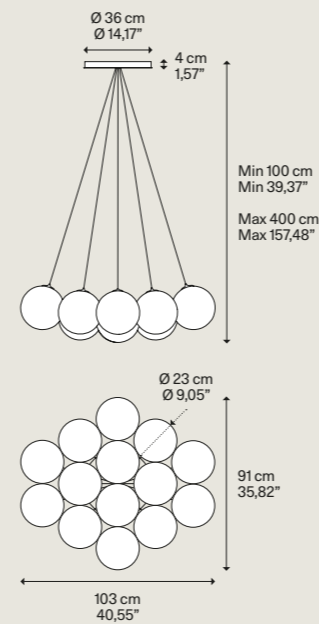

Blown glass diffuser Diffusore in vetro soffiato
Clear Trasparente
Frosted White Bianco Satinato
Chrome Cromo
Glossy Smoke Fumo Lucido
Glossy Bronze Bronzo Lucido
Gold Oro
Rose Gold Oro Rosa

Metal canopy Rosone in metallo
Matte White - 9010 Bianco Opaco - 9010

Code Codice	A	Code Codice	B
22123 0027		22123 0030	
22123 1327		22123 1330	
22123 4027		22123 4030	
22123 4327		22123 4330	
22123 4627		22123 4630	
22123 5027		22123 5030	
22123 5527		22123 5530	

Light source Sorgente luminosa	A
LED	
2700	K
14x 3	W
6300	lm
350	mA
CRI 90	
MacAdam 3-Step	
LED and driver included LED e driver inclusi	

Light source Sorgente luminosa	B
LED	
3000	K
14x 3	W
6720	lm
350	mA
CRI 90	
MacAdam 3-Step	
LED and driver included LED e driver inclusi	

Net weight Peso netto	11,50 kg 25,35 lbs	Pack Colli	29	Energy class Classe energetica	D
--------------------------	-----------------------	---------------	----	-----------------------------------	---

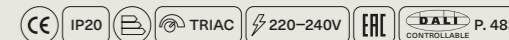

Random Cloud 7 Lights Ø28

Blown glass diffuser Diffusore in vetro soffiato
Clear Trasparente
Frosted White Bianco Satinato
Chrome Cromo
Glossy Smoke Fumo Lucido
Glossy Bronze Bronzo Lucido
Gold Oro
Rose Gold Oro Rosa

Metal canopy Rosone in metallo
Matte White - 9010 Bianco Opaco - 9010

Code Codice	A	Code Codice	B
22122 0027		22122 0030	
22122 1327		22122 1330	
22122 4027		22122 4030	
22122 4327		22122 4330	
22122 4627		22122 4630	
22122 5027		22122 5030	
22122 5527		22122 5530	

Light source Sorgente luminosa	A
LED	
2700	K
7x 3	W
3150	lm
350	mA
CRI 90	
MacAdam 3-Step	
LED and driver included LED e driver inclusi	

Light source Sorgente luminosa	B
LED	
3000	K
7x 3	W
3360	lm
350	mA
CRI 90	
MacAdam 3-Step	
LED and driver included LED e driver inclusi	

Net weight Peso netto	7,30 kg 16,09 lbs	Pack Colli	15	Energy class Classe energetica	D
--------------------------	----------------------	---------------	----	-----------------------------------	---

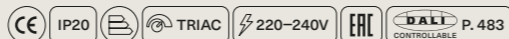

Random Cloud 14 Lights Ø28

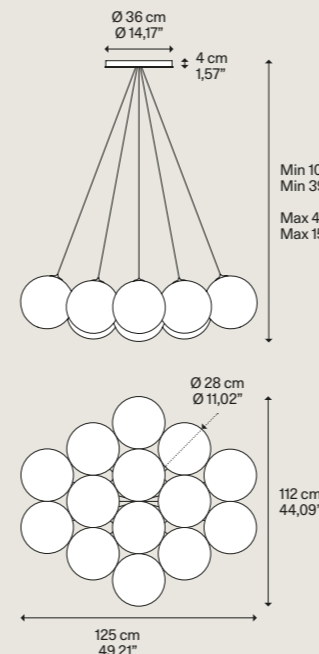

Blown glass diffuser Diffusore in vetro soffiato
Clear Trasparente
Frosted White Bianco Satinato
Chrome Cromo
Glossy Smoke Fumo Lucido
Glossy Bronze Bronzo Lucido
Gold Oro
Rose Gold Oro Rosa

Metal canopy Rosone in metallo
Matte White - 9010 Bianco Opaco - 9010

Code Codice	A	Code Codice	B
22124 0027		22124 0030	
22124 1327		22124 1330	
22124 4027		22124 4030	
22124 4327		22124 4330	
22124 4627		22124 4630	
22124 5027		22124 5030	
22124 5527		22124 5530	

Light source Sorgente luminosa	A
LED	
2700	K
14x 3	W
6300	lm
350	mA
CRI 90	
MacAdam 3-Step	
LED and driver included LED e driver inclusi	

Light source Sorgente luminosa	B
LED	
3000	K
14x 3	W
6720	lm
350	mA
CRI 90	
MacAdam 3-Step	
LED and driver included LED e driver inclusi	

Net weight Peso netto	15,70 kg 34,61 lbs	Pack Colli	29	Energy class Classe energetica	D
--------------------------	-----------------------	---------------	----	-----------------------------------	---

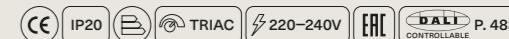

CATEGORY SUSPENSION LAMP

DESIGN Chia-Ying Lee, 2024

Random Cloud 19 Lights Ø23

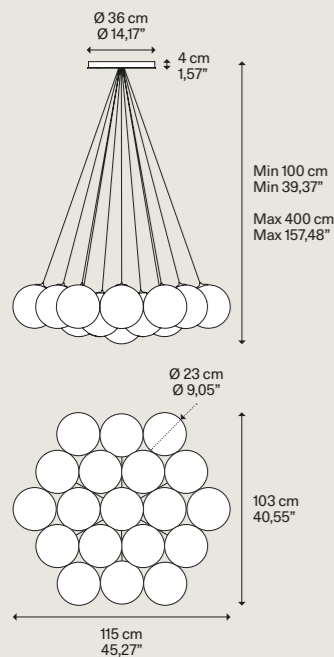

Blown glass diffuser  
Diffusore in vetro soffiato

Clear Trasparente
Frosted White Bianco Satinato
Chrome Cromo
Glossy Smoke Fumo Lucido
Glossy Bronze Bronzo Lucido
Gold Oro
Rose Gold Oro Rosa

Metal canopy  
Rosone in metallo

Matte White - 9010 Bianco Opaco - 9010
---

Code Codice	A	Code Codice	B
22125 0027		22125 0030	
22125 1327		22125 1330	
22125 4027		22125 4030	
22125 4327		22125 4330	
22125 4627		22125 4630	
22125 5027		22125 5030	
22125 5527		22125 5530	

Light source  
Sorgente luminosa

LED	A
2700	K
19x 3	W
8550	lm
350	mA
CRI 90	
MacAdam 3-Step	

LED and driver included  
LED e driver inclusi

Light source  
Sorgente luminosa

LED	B
3000	K
19x 3	W
9120	lm
350	mA
CRI 90	
MacAdam 3-Step	

LED and driver included  
LED e driver inclusi

Net weight Peso netto	14,50 kg 31,96 lbs	Pack Colli	39	Energy class Classe energetica	D
--------------------------	-----------------------	---------------	----	-----------------------------------	---

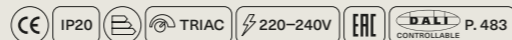

CATEGORY SUSPENSION LAMP

DESIGN Chia-Ying Lee, 2024

Random Cloud 23 Lights Ø23

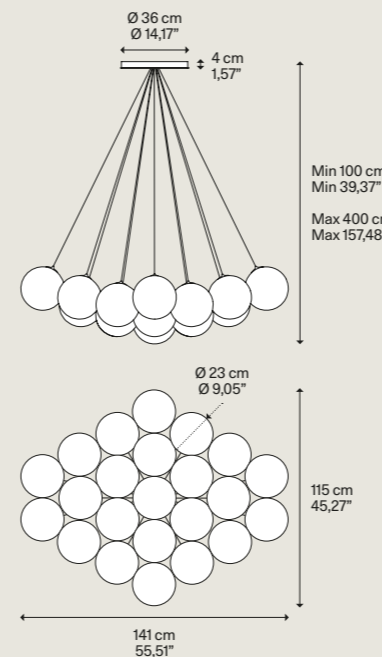

Blown glass diffuser  
Diffusore in vetro soffiato

Clear Trasparente
Frosted White Bianco Satinato
Chrome Cromo
Glossy Smoke Fumo Lucido
Glossy Bronze Bronzo Lucido
Gold Oro
Rose Gold Oro Rosa

Metal canopy  
Rosone in metallo

Matte White - 9010 Bianco Opaco - 9010
---

Code Codice	A	Code Codice	B
22127 0027		22127 0030	
22127 1327		22127 1330	
22127 4027		22127 4030	
22127 4327		22127 4330	
22127 4627		22127 4630	
22127 5027		22127 5030	
22127 5527		22127 5530	

Light source  
Sorgente luminosa

LED	A
2700	K
23x 3	W
10350	lm
350	mA
CRI 90	
MacAdam 3-Step	

LED and driver included  
LED e driver inclusi

Light source  
Sorgente luminosa

LED	B
3000	K
23x 3	W
11040	lm
350	mA
CRI 90	
MacAdam 3-Step	

LED and driver included  
LED e driver inclusi

Net weight Peso netto	16,90 kg 37,25 lbs	Pack Colli	47	Energy class Classe energetica	D
--------------------------	-----------------------	---------------	----	-----------------------------------	---

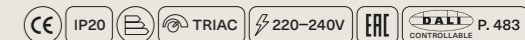

Random Cloud 19 Lights Ø28

Blown glass diffuser  
Diffusore in vetro soffiato

Clear Trasparente
Frosted White Bianco Satinato
Chrome Cromo
Glossy Smoke Fumo Lucido
Glossy Bronze Bronzo Lucido
Gold Oro
Rose Gold Oro Rosa

Metal canopy  
Rosone in metallo

Matte White - 9010 Bianco Opaco - 9010
---

Code Codice	A	Code Codice	B
22126 0027		22126 0030	
22126 1327		22126 1330	
22126 4027		22126 4030	
22126 4327		22126 4330	
22126 4627		22126 4630	
22126 5027		22126 5030	
22126 5527		22126 5530	

Light source  
Sorgente luminosa

LED	A
2700	K
19x 3	W
8550	lm
350	mA
CRI 90	
MacAdam 3-Step	

LED and driver included  
LED e driver inclusi

Light source  
Sorgente luminosa

LED	B
3000	K
19x 3	W
9120	lm
350	mA
CRI 90	
MacAdam 3-Step	

LED and driver included  
LED e driver inclusi

Net weight Peso netto	20,20 kg 44,53 lbs	Pack Colli	39	Energy class Classe energetica	D
--------------------------	-----------------------	---------------	----	-----------------------------------	---

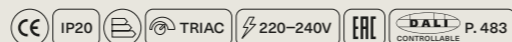

Random Cloud 23 Lights Ø28

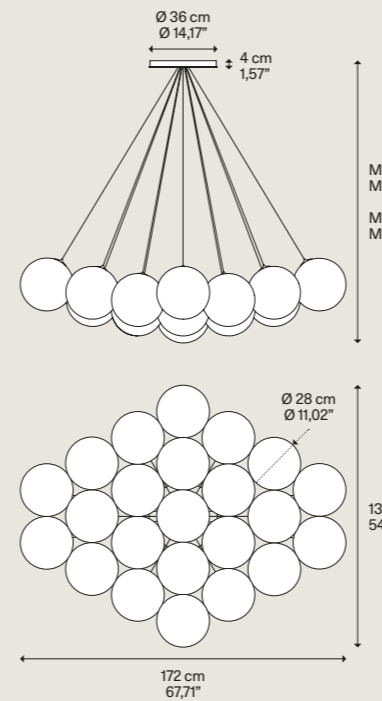

Blown glass diffuser  
Diffusore in vetro soffiato

Clear Trasparente
Frosted White Bianco Satinato
Chrome Cromo
Glossy Smoke Fumo Lucido
Glossy Bronze Bronzo Lucido
Gold Oro
Rose Gold Oro Rosa

Metal canopy  
Rosone in metallo

Matte White - 9010 Bianco Opaco - 9010
---

Code Codice	A	Code Codice	B
22128 0027		22128 0030	
22128 1327		22128 1330	
22128 4027		22128 4030	
22128 4327		22128 4330	
22128 4627		22128 4630	
22128 5027		22128 5030	
22128 5527		22128 5530	

Light source  
Sorgente luminosa

LED	A
2700	K
23x 3	W
10350	lm
350	mA
CRI 90	
MacAdam 3-Step	

LED and driver included  
LED e driver inclusi

Light source  
Sorgente luminosa

LED	B
3000	K
23x 3	W
11040	lm
350	mA
CRI 90	
MacAdam 3-Step	

LED and driver included  
LED e driver inclusi

Net weight Peso netto	23,80 kg 52,47 lbs	Pack Colli	47	Energy class Classe energetica	D
--------------------------	-----------------------	---------------	----	-----------------------------------	---

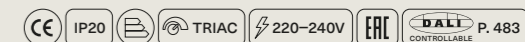



# Elara

Designed by Nika Zupanc

Year 2022

The name *Elara* connotes astronomy and Greek mythology, and its geometric design mimicks the trajectory of the planets within the universe. Inspired by astral motion, the lamp is characterised by two metal rings, one of which can be set at various angles to produce fluidity and movement, as well as a small sphere at the bottom of the lamp that contains the light source. The central ring can be positioned to reach different heights and angles, allowing users to experiment with casting light and shadows. The light source emits a glow that can illuminate an entire room. Additionally, when the lamp is off, users can direct the bi-emission sphere – up or down – according to the need for light.

Il nome *Elara* richiama l'astronomia e la mitologia greca, e il suo design geometrico imita la traiettoria dei pianeti nell'universo. Ispirata al movimento astrale, la lampada è caratterizzata da due anelli metallici, uno dei quali può essere posizionato a varie angolazioni per produrre fluidità e movimento, e da una piccola sfera all'estremità inferiore della lampada che contiene la sorgente luminosa. L'anello centrale può essere posizionato in modo da raggiungere diverse altezze e angolazioni, consentendo agli utenti di sperimentare la proiezione di luci e ombre. La sorgente luminosa emette un bagliore che può illuminare un'intera stanza. Inoltre quando la lampada è spenta, è possibile per gli utenti orientare la sfera a doppia emissione – verso l'alto o verso il basso – in base alle esigenze di luce.

Go to the technical info [+](#) Click to discover more [↓](#)

Elara cod. 206	CATEGORY LAMP		TYPE OF LIGHT	
	Suspension	Sospensione	Symmetrical diffused light Adjustable light	Luce simmetrica diffusa Luce orientabile
				



Elara medium and large, FINISHES Black and Gold.





1 Side I, power 75%  
2 Side II, power 25%





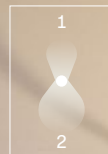

1 Side II, power 25%  
2 Side I, power 75%

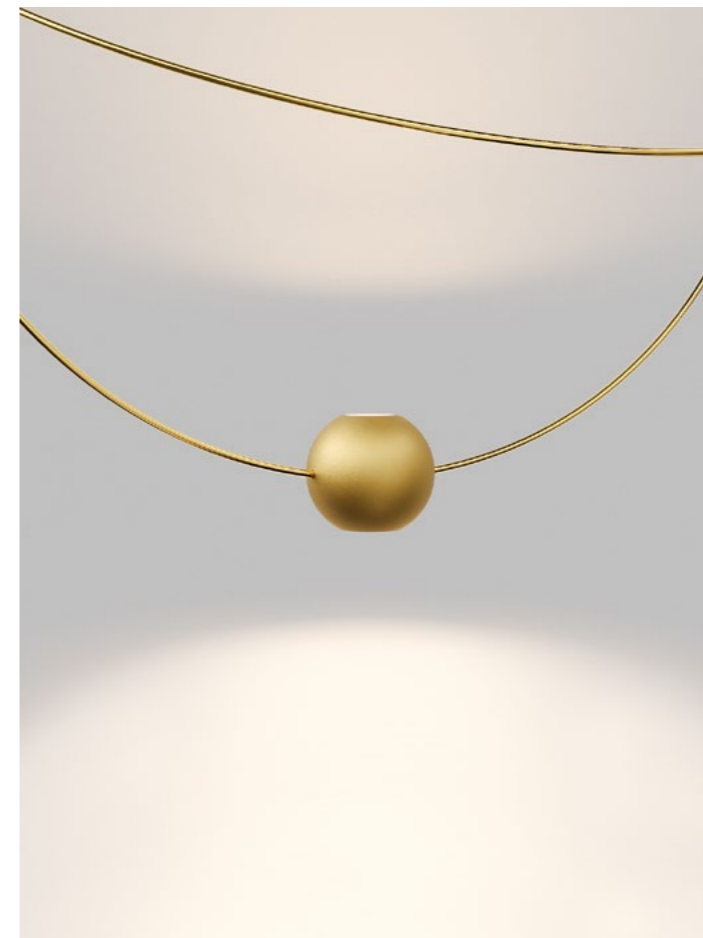

Elara, metal sphere, side I (down) side II (up), FINISH Matte Gold.

↑ 25%



↓ 75%

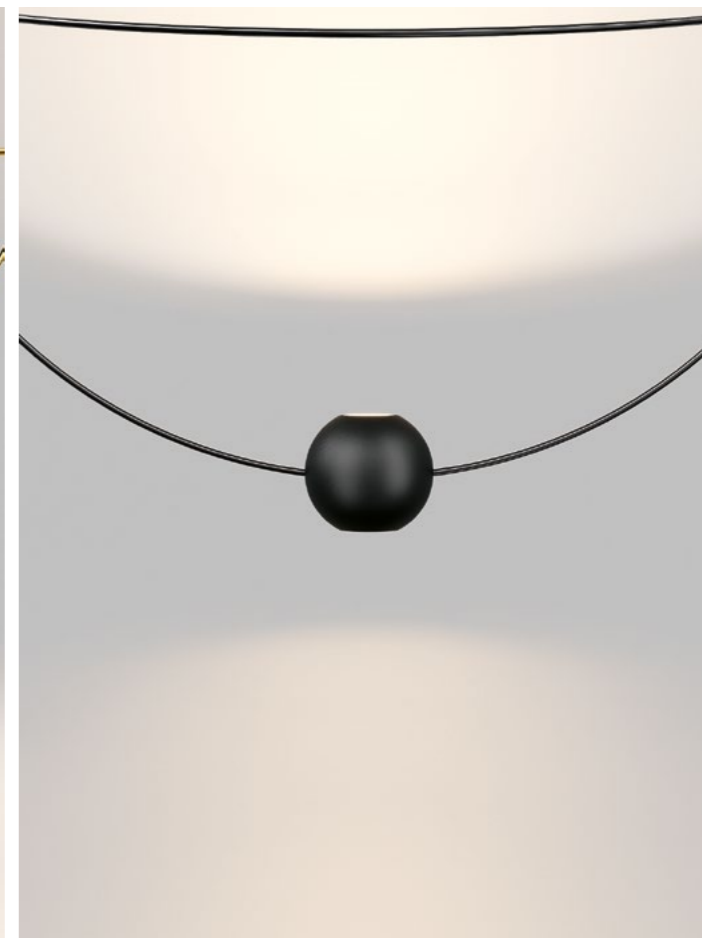

Elara, metal sphere, side I (up) side II (down), FINISH Extra Matte Black.

↑ 75%



↓ 25%

During the installation, it is possible to choose the amount of *light* emitted by the light source, adjusting the orientation of the sphere to bring more light upwards or on the downwards.

In fase in installazione è possibile scegliere la quantità di *luce* emessa dalla sorgente luminosa, regolando l'orientamento della sfera per ottenere più luce verso l'alto o sul piano.

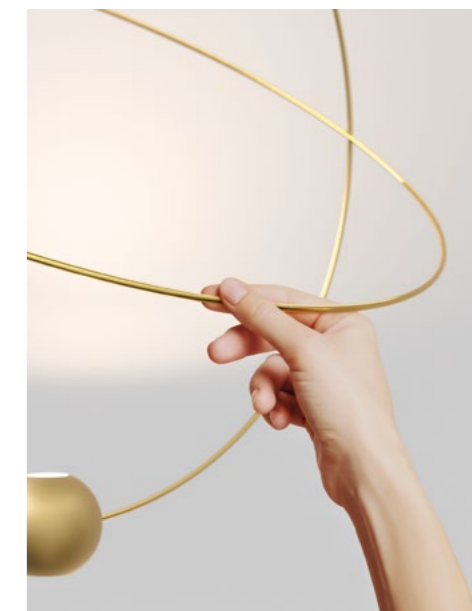

Elara is characterised by two metal rings, one of which can be set at various angles.

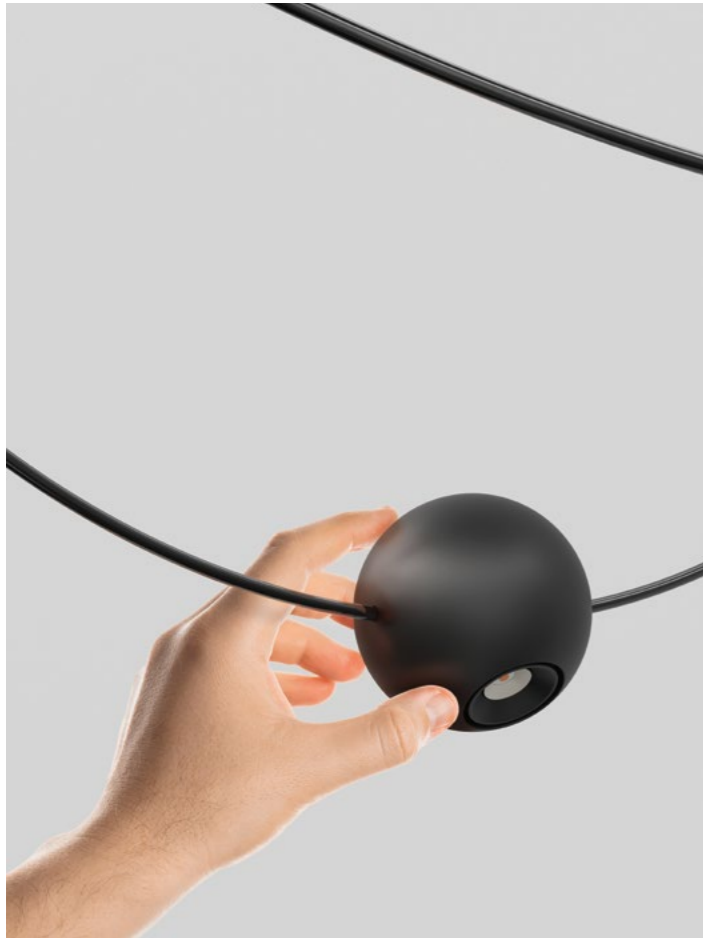

Elara, metal sphere, FINISH Extra Matte Black.



Elara, metal rings, FINISH Glossy Black.

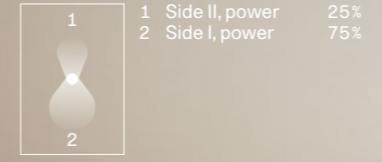

Elara large, FINISH Black.



Le nom *Elara* évoque l'astronomie et la mythologie grecque, et son design géométrique imite la trajectoire des planètes dans l'univers. S'inspirant du mouvement astral, la lampe se caractérise par deux anneaux métalliques : un pouvant être positionné à différents angles, créant ainsi fluidité et mouvement, et par une petite sphère à l'extrémité inférieure de la lampe qui abrite la source lumineuse. L'anneau central peut être positionné pour atteindre différents angles et hauteurs, permettant aux utilisateurs d'expérimenter la projection de lumière et d'ombre. La source lumineuse émet un rayonnement lumineux qui peut éclairer toute une pièce. De plus, lorsque la lampe est éteinte, les utilisateurs peuvent orienter la sphère à double émission – vers le haut ou vers le bas – en fonction des exigences de lumière. ● FR

Der Name *Elara* erinnert an die Astronomie und die griechische Mythologie, und so ahmt das geometrische Design der Leuchte die Flugbahn der Planeten im Universum nach. Inspiriert von diesen astralen Bewegungen besteht die Leuchte aus zwei Metallringen, von denen einer in verschiedenen Winkeln positioniert werden kann, um eine fließende Bewegung zu erzeugen, sowie aus einer kleinen Kugel am unteren Ende der Leuchte, welche die Lichtquelle enthält. Der zentrale Ring kann in verschiedenen Höhen und Winkeln positioniert werden, so dass die Benutzer mit der Projektion von Licht und Schatten experimentieren können. Die Lichtquelle strahlt ein Licht aus, das einen ganzen Raum erhellen kann. Außerdem kann der Benutzer die Dual-Emissionskugel bei ausgeschalteter Leuchte je nach Lichtbedarf nach oben oder nach unten ausrichten. ● DE

El nombre *Elara* evoca la astronomía y la mitología griega y su diseño geométrico imita la trayectoria de los planetas en el universo. Inspirada en el movimiento astral, la lámpara se caracteriza por dos anillos metálicos, uno de los cuales se puede colocar en distintos ángulos para crear fluidez y movimiento, y una pequeña esfera en el extremo inferior de la lámpara que contiene la fuente luminosa. El anillo central se puede colocar de forma que alcance distintas alturas y ángulos y permite a los usuarios experimentar la proyección de luces y sombras. La fuente luminosa emite un destello que puede iluminar toda una habitación. Además, cuando la lámpara está apagada, los usuarios pueden orientar la esfera con doble emisión – hacia arriba o hacia abajo – dependiendo de la luz que se necesite. ● ES

Название *Elara* напоминает нам об астрономии и греческой мифологии, ее геометрический дизайн имитирует траектории движения планет во вселенной. Лампа, вдохновленная движением звезд, имеет два металлических кольца, одно из которых может устанавливаться под разными углами, создавая текучесть и мобильность, и небольшую сферу на нижней стороне лампы, содержащей внутри источник освещения. Центральное кольцо можно располагать на различной высоте и под разными углами, что позволяет пользователям экспериментировать с проекцией света и тени. Источник света излучает свечение, наполняющее всю комнату. Кроме того, когда лампа выключена, пользователи могут ориентировать сферу с двойным излучением вверх или вниз в зависимости от потребности в освещении. ● RU

*Elara*—名呼应天文学和希腊神话,同时它的几何设计还仿照宇宙中的行星运行轨迹。受星体运动的启发,两只金属圆环是这款灯的特色所在,其中一只能够以不同角度定位,从而产生流动性和运动性,并使灯体下端形成一个容纳光源的小球体。中心圆环通过定位可达到不同高度和角度,允许用户尝试光与影的投射。光源发出的光芒可照亮整个房间。此外,当灯熄灭时,用户可以根据自身的光线需求将双发射球体向上或向下调转。● ZH

CATEGORY SUSPENSION LAMP

Elara medium

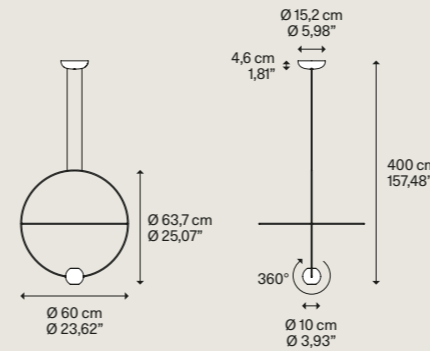

Net weight	1,67 kg	Pack	1	Energy class	2700 K ▶ D+E
Peso netto	3,68 lbs	Colli	1	Classe energetica	3000 K ▶ D+F

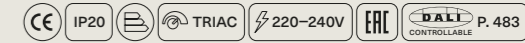

DESIGN Nika Zupanc 2022

Metal structure  
Montatura in metallo

- Glossy Black  
Nero Lucido
- Glossy Gold  
Oro Lucido

Metal sphere  
Sfera in metallo

- Extra Matte Black  
Nero Extra Opaco
- Matte Gold  
Oro Opaco

Code Codice	Code Codice
-------------	-------------

20621 2227	20621 2230
20621 5027	20621 5030

Light source  
Sorgente luminosa

- LED 2700 K
- 18+9 W
- 2100 lm-side I
- 800 lm-side II
- 1000 mA
- CRI 90
- MacAdam 3-Step

LED and driver included  
LED e driver inclusi

Light source  
Sorgente luminosa

- LED 3000 K
- 18+9 W
- 2260 lm-side I
- 845 lm-side II
- 1000 mA
- CRI 90
- MacAdam 3-Step

LED and driver included  
LED e driver inclusi

Elara large

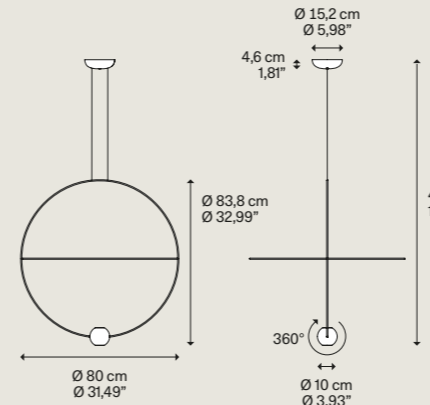

Net weight	1,87 kg	Pack	1	Energy class	2700 K ▶ D+E
Peso netto	4,12 lbs	Colli	1	Classe energetica	3000 K ▶ D+F



Metal structure  
Montatura in metallo

- Glossy Black  
Nero Lucido
- Glossy Gold  
Oro Lucido

Metal sphere  
Sfera in metallo

- Extra Matte Black  
Nero Extra Opaco
- Matte Gold  
Oro Opaco

Code Codice	Code Codice
-------------	-------------

20622 2227	20622 2230
20622 5027	20622 5030

Light source  
Sorgente luminosa

- LED 2700 K
- 18+9 W
- 2100 lm-side I
- 800 lm-side II
- 1000 mA
- CRI 90
- MacAdam 3-Step

LED and driver included  
LED e driver inclusi

Light source  
Sorgente luminosa

- LED 3000 K
- 18+9 W
- 2260 lm-side I
- 845 lm-side II
- 1000 mA
- CRI 90
- MacAdam 3-Step

LED and driver included  
LED e driver inclusi

Elara medium ↗ Suspension lamp



Elara large ↗ Suspension lamp



Adjustable light  
Luce orientabile

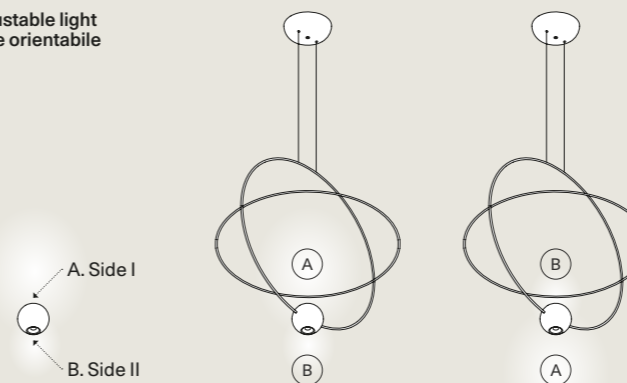

Adjustable ring  
Anello orientabile

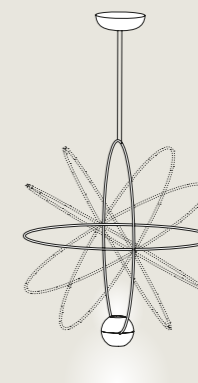

# Sky-Fall

Designed by Studio Italia Design

Year 2014, 2024

In *Sky-Fall*, the traditional glass processing techniques embrace the most advanced LED technologies. The shape of *Sky-Fall* captures the imagination in its reminiscence of ancient decanters in precious blown glass. Its function amazes thanks to the innovative double LED source that diffuses direct and indirect light. Available in two sizes and in four finishes, and in 2700 or 3000 K light colour temperature versions, *Sky-Fall* decorates both when it is on and when it is off. Now added to the family is the new *Sky-Fall Round*: a further variant featuring a spherically shaped diffuser available in two sizes and four finishes, including the new, precious golden sage. The new finish also extends to *Sky-Fall* in both sizes.

In *Sky-Fall* le tradizionali tecniche di lavorazione del vetro abbracciano le tecnologie LED più avanzate. La forma di *Sky-Fall* emoziona ricordando antichi decanter in prezioso vetro soffiato. La sua funzione stupisce grazie all'innovativa doppia sorgente a LED che diffonde luce diretta e indiretta. Disponibile in due dimensioni e in quattro finiture, e nelle versioni con temperatura colore a 2700 K o 3000 K, *Sky-Fall* arreda sia da accesa che da spenta. Si aggiunge ora alla famiglia la nuova *Sky-Fall Round*: un'ulteriore variante che presenta un diffusore dalla forma sferica disponibile in due dimensioni e quattro finiture, inclusa la nuova e preziosa golden sage (salvia dorata). La nuova finitura si estende anche a *Sky-Fall* in entrambe le misure.

Go to the technical info



Click to discover more



Sky-Fall  
COD. 148

CATEGORY LAMP

Suspension

Sospensione

TYPE OF LIGHT

Diffused light

Luce diffusa



Sky-Fall Round large and Sky-Fall medium, FINISHES Golden Sage and Clear.















Clear



Glossy Smoke



Glossy Bronze

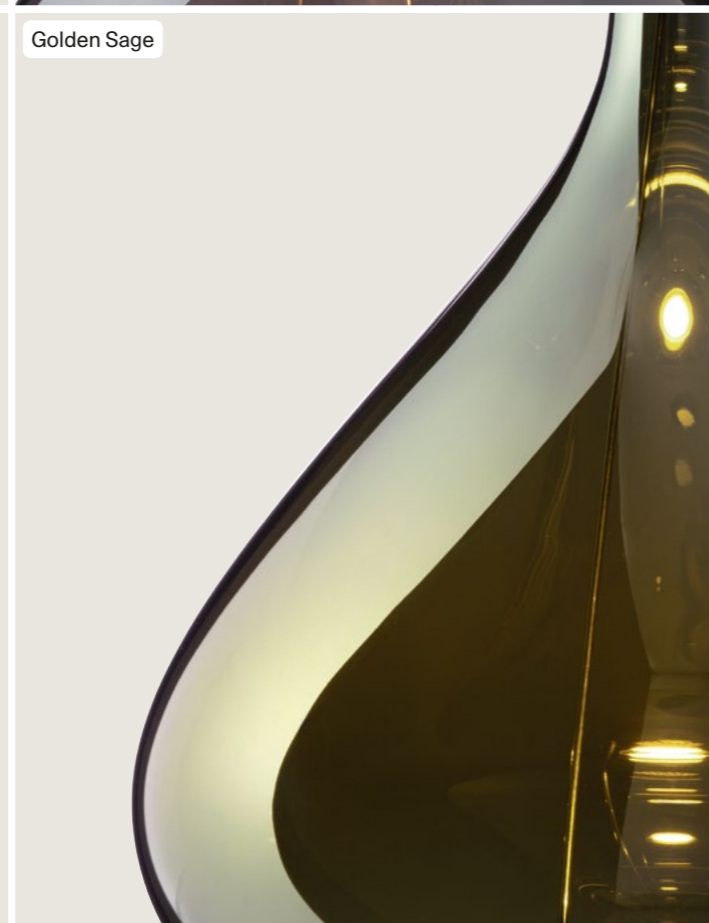

Golden Sage

Avec *Sky-Fall*, les techniques traditionnelles d'ennoblissement du verre embrassent les technologies LED les plus pointues. La Forme de *Sky-Fall* émeut car elle évoque les anciens décanteurs en verre soufflé précieux. Sa fonction surprend avec sa double source à LED qui diffuse de la lumière directe et indirecte. Disponible en deux dimensions et quatre finitions, dans les versions avec température couleur à 2700 K ou 3000 K, *Sky-Fall*, allumée ou éteinte, se prête à la création d'atmosphères. La nouvelle *Sky-Fall Round* rejoint la famille : une autre variante qui présente un diffuseur de forme sphérique disponible en deux dimensions et quatre finitions, comprenant la nouvelle et précieuse Golden Sage (saugée dorée). La nouvelle finition s'applique également à *Sky-Fall* dans les deux dimensions. ● FR

Bei *Sky-Fall* treffen traditionelle Glasverarbeitungstechniken auf fortschrittlichste LED-Technologien. Die Form von *Sky-Fall* begeistert und erinnert an alte Dekanter aus hochwertigem, geblasenem Glas. Seine Funktion beeindruckt dank der innovativen, doppelten LED-Lichtquelle, die gleichzeitig für direkte und indirekte Beleuchtung sorgt. *Sky-Fall* ist in zwei Größen und vier Ausführungen sowie in den Farbtemperaturen 2700 K oder 3000 K erhältlich und stattet den Raum sowohl im eingeschalteten als auch im ausgeschalteten Zustand aus. Jetzt wird die Familie um die neue *Sky-Fall Round* erweitert: eine weitere Variante mit einem kugelförmigen Diffusor, die in zwei Größen und vier Ausführungen erhältlich ist, darunter das neue, edle Golden Sage (Salbei Gold). Die neue Ausführung erstreckt sich auch auf *Sky-Fall* in beiden Größen. ● DE

En *Sky-Fall* las tradicionales técnicas de elaboración del vidrio abrazan las tecnologías LED más avanzadas. La forma de *Sky-Fall* emociona recordando antiguos decantadores en precioso vidrio soplado. Su función sorprende gracias a la innovadora doble fuente de LED que difunde luz directa e indirecta. Disponible en dos tamaños, en cuatro acabados y en las versiones con una temperatura de color de 2700 o 3000 K, *Sky-Fall* decora tanto encendida como apagada. Ahora se añade a la familia la nueva *Sky-Fall Round*: una variante adicional con un difusor de forma esférica disponible en dos tamaños y cuatro acabados, incluida la nueva y preciosa golden sage (salvia dorada). El nuevo acabado también abarca *Sky-Fall* en ambas medidas. ● ES

Традиционная техника обработки стекла сочетается в *Sky-Fall* с наиболее совершенными светодиодными технологиями. Форма *Sky-Fall* захватывает воображение отсылкой к старинным декантерам из драгоценного дутого стекла. Он отличается поразительной функциональностью, благодаря инновационному двойному светодиодному источнику, который рассеивает прямой и непрямой свет. Светильник выпускается в двух размерах и четырех вариантах отделки, и в версии с цветовой температурой 2700 или 3000 K *Sky-Fall* украшает помещение как во включенном, так и в выключенном состоянии. Теперь к семейству светильников добавился новый *Sky-Fall Round*: это дополнительный вариант со сферическим диффузором, доступный в двух размерах и четырех вариантах отделки, включая новую драгоценную отделку golden sage (золотой шалфей). Новая отделка также распространяется на *Sky-Fall* обоих размеров. ● RU

*Sky-Fall*将传统的玻璃处理工艺与最为先进的LED技术完美融合。*Sky-Fall*的形状精美,令人忆起以珍贵玻璃吹制工艺精制而成的古老醒酒器。得益于创新型双LED光源散射而出的直接与间接光线,它的功能令人赞叹。提供两种尺寸和四种饰面,同时还有2700 K或3000 K色温的两个版本,无论是在点亮或熄灭时皆可营造迷人装饰效果。该系列现在还添入了全新的*Sky-Fall Round*:一款带有球形灯罩的延伸产品,提供两种尺寸和两种饰面,包含新颖珍贵的Golden Sage(金鼠尾草色)饰面。这款全新饰面也将延伸至*Sky-Fall*的两种尺寸中。● ZH



Sky-Fall medium ↘ Suspension lamp

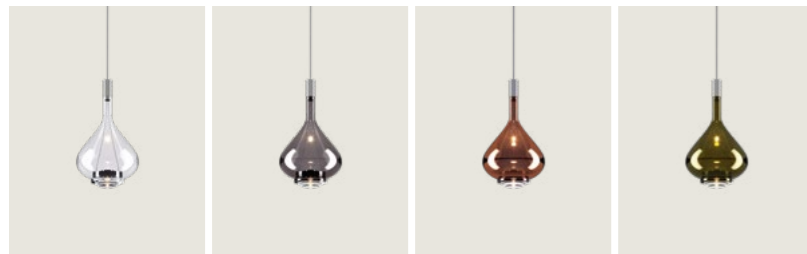

Sky-Fall large ↘ Suspension lamp



Sky-Fall Round medium ↘ Suspension lamp



Sky-Fall Round large ↘ Suspension lamp

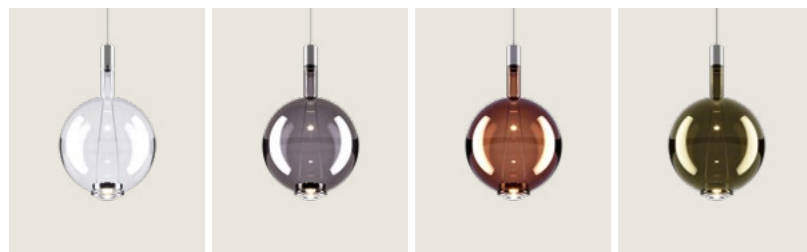

Double canopy

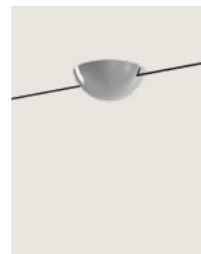

CATEGORY SUSPENSION LAMP

Sky-Fall medium

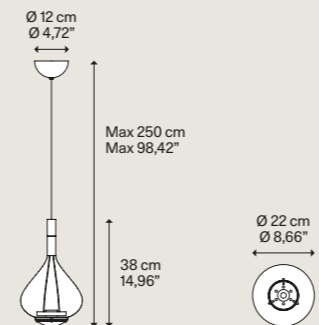

Net weight	1,65 kg	Pack	2	Energy class	E
Peso netto	3,64 lbs	Colli	2	Classe energetica	E

DESIGN Studio Italia Design, 2014

Metal structure  
Montatura in metallo

- Chrome Cromo

Blown glass diffuser  
Diffusore in vetro soffiato

	Code Codice <sup>A</sup>	Code Codice <sup>B</sup>
Clear Trasparente	14822 0027	14822 0030
Glossy Smoke Fumo Lucido	14822 4327	14822 4330
Glossy Bronze Bronzo Lucido	14822 4627	14822 4630
Golden Sage Salvia Dorata	14822 7127	14822 7130

Light source  
Sorgente luminosa <sup>A</sup>

LED  
2700 K  
2x 8,5 W  
1815 lm  
350 mA  
CRI 95  
MacAdam 3-Step

LED and driver included  
LED e driver inclusi

Light source  
Sorgente luminosa <sup>B</sup>

LED  
3000 K  
2x 8,5 W  
1870 lm  
350 mA  
CRI 95  
MacAdam 3-Step

LED and driver included  
LED e driver inclusi

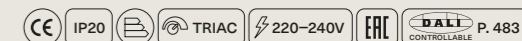

Sky-Fall large

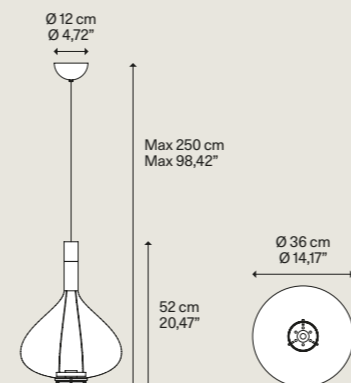

Net weight	3,05 kg	Pack	2	Energy class	E
Peso netto	6,72 lbs	Colli	2	Classe energetica	E

Metal structure  
Montatura in metallo

- Chrome Cromo

Blown glass diffuser  
Diffusore in vetro soffiato

	Code Codice <sup>A</sup>	Code Codice <sup>B</sup>
Clear Trasparente	14821 0027	14821 0030
Glossy Smoke Fumo Lucido	14821 4327	14821 4330
Glossy Bronze Bronzo Lucido	14821 4627	14821 4630
Golden Sage Salvia Dorata	14821 7127	14821 7130

Light source  
Sorgente luminosa <sup>A</sup>

LED  
2700 K  
2x 8,5 W  
1815 lm  
350 mA  
CRI 95  
MacAdam 3-Step

LED and driver included  
LED e driver inclusi

Light source  
Sorgente luminosa <sup>B</sup>

LED  
3000 K  
2x 8,5 W  
1870 lm  
350 mA  
CRI 95  
MacAdam 3-Step

LED and driver included  
LED e driver inclusi

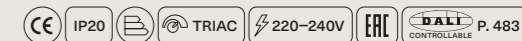

CATEGORY **SUSPENSION LAMP**

DESIGN Studio Italia Design, 2024

### Sky-Fall Round medium

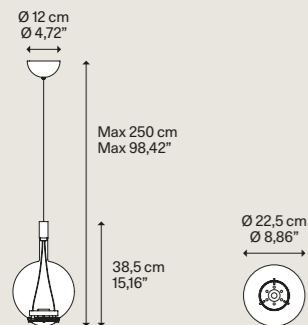

Net weight	1,47 kg	Pack	2	Energy class	E
Peso netto	3,24 lbs	Colli		Classe energetica	

Metal structure Montatura in metallo	Blown glass diffuser Diffusore in vetro soffiato	Code Codice	A	Code Codice	B
Chrome Cromo	Clear Trasparente	14824 0027		14824 0030	
	Glossy Smoke Fumo Lucido	14824 4327		14824 4330	
	Glossy Bronze Bronzo Lucido	14824 4627		14824 4630	
	Golden Sage Salvia Dorata	14824 7127		14824 7130	

Light source Sorgente luminosa		A
LED		
2700	K	
2x 8,5	W	
1815	lm	
350	mA	
CRI 95		
MacAdam 3-Step		
LED and driver included LED e driver inclusi		

Light source Sorgente luminosa		B
LED		
3000	K	
2x 8,5	W	
1870	lm	
350	mA	
CRI 95		
MacAdam 3-Step		
LED and driver included LED e driver inclusi		

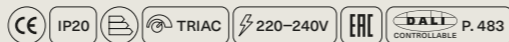

### Sky-Fall Round large

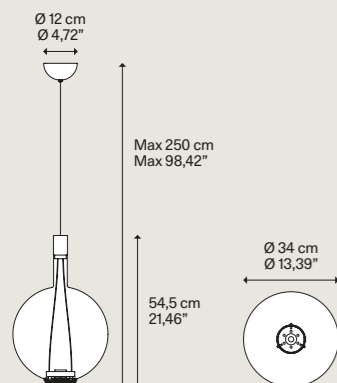

Net weight	2,64 kg	Pack	2	Energy class	E
Peso netto	5,82 lbs	Colli		Classe energetica	

Metal structure Montatura in metallo	Blown glass diffuser Diffusore in vetro soffiato	Code Codice	A	Code Codice	B
Chrome Cromo	Clear Trasparente	14823 0027		14823 0030	
	Glossy Smoke Fumo Lucido	14823 4327		14823 4330	
	Glossy Bronze Bronzo Lucido	14823 4627		14823 4630	
	Golden Sage Salvia Dorata	14823 7127		14823 7130	

Light source Sorgente luminosa		A
LED		
2700	K	
2x 8,5	W	
1815	lm	
350	mA	
CRI 95		
MacAdam 3-Step		
LED and driver included LED e driver inclusi		

Light source Sorgente luminosa		B
LED		
3000	K	
2x 8,5	W	
1870	lm	
350	mA	
CRI 95		
MacAdam 3-Step		
LED and driver included LED e driver inclusi		

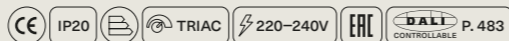

CATEGORY **DOUBLE CANOPY**

### Sky-Fall double canopy

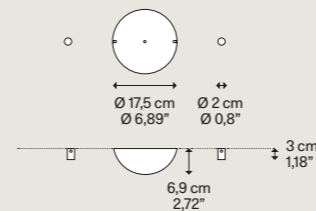

Net weight	0,56 kg	Pack	1
Peso netto	1,23 lbs	Colli	

CATEGORY **WALL CANOPY**

### Wall Standard

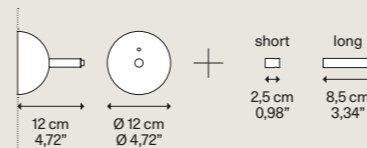

Net weight	0,40 kg	Pack	1
Peso netto	0,88 lbs	Colli	

CATEGORY **TRACK**

### Short Lights Track

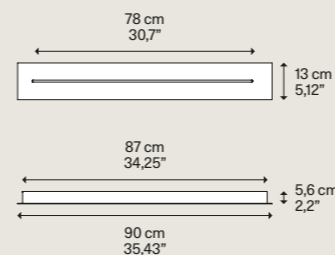

Net weight	7,33 kg	Pack	1
Peso netto	16,16 lbs	Colli	

### Long Lights Track

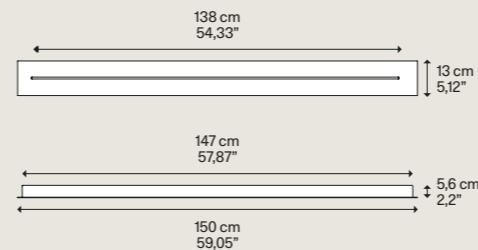

Net weight	11,85 kg	Pack	1
Peso netto	26,12 lbs	Colli	

Description Descrizione	Metal structure Montatura in metallo	System Sistema	Code Codice
Double canopy mod. Sky-Fall Rosone doppio mod. Sky-Fall	Chrome Cromo	Sky-Fall System	R99L02 4000

Description Descrizione	Metal structure Montatura in metallo	System Sistema	Code Codice
Wall bracket mod. Sky-Fall Rosone a parete mod. Sky-Fall	Chrome Cromo	Sky-Fall System	R12L01 4000

Description Descrizione	Metal structure Struttura in metallo	System Sistema	Code Codice
Multiple linear track mod. Sky-Fall max 3 suspensions	Matte White - 9010 Bianco Opaco - 9010	Track	R08L07 1000
Binario lineare multiplo mod. Sky-Fall max 3 sospensioni	Matte Black - 9005 Nero Opaco - 9005		R08L07 2000

Description Descrizione	Metal structure Struttura in metallo	System Sistema	Code Codice
Multiple linear track mod. Sky-Fall max 5 suspensions	Matte White - 9010 Bianco Opaco - 9010	Track	R08L11 1000
Binario lineare multiplo mod. Sky-Fall max 5 sospensioni	Matte Black - 9005 Nero Opaco - 9005		R08L11 2000

► WALL STANDARD Both accessories in the two available lengths are supplied in the box with the wall bracket. ► TRACK Tracks are only for Sky-Fall suspensions. Each suspension should be separated from the canopy and installed on the track. Each suspension should be installed on the track using the driver removed from the original canopy.

► WALL STANDARD Entrambi gli accessori nelle due diverse lunghezze sono inclusi nella confezione con il supporto a parete. ► TRACK I binari sono utilizzabili solo con le sospensioni Sky-Fall che dovranno essere separate dai rosone ed installate sui binari. Per ogni sospensione dovrà essere installato nel binario il rispettivo driver rimosso dal rosone originale.



# Kelly

Designed by Andrea Toso

Year 2015

Seductive beauty with a bold personality thanks to the strong and precise laser cuts, which lighten the metal of the lampshade and create an intriguing play of light and shadow. *Kelly* is a multifaceted family of suspension lamps that stands out with elegance in any living space thanks to the variety of available forms and finishes.

Una bellezza seducente dalla personalità audace grazie a tagli laser forti e precisi che alleggeriscono il metallo del paralume e creano un intrigante gioco di luci e ombre. *Kelly* è una famiglia poliedrica di lampade a sospensione che si distingue con eleganza in ogni ambiente abitativo grazie alla varietà di forme e finiture disponibili.



[Go to the technical info](#) [+](#)
[Click to discover more](#) [↓](#)

Kelly  
COD. 141

CATEGORY LAMP

Suspension      Sospensione



TYPE OF LIGHT

Symmetrical diffused light      Luce simmetrica diffusa















Une beauté séduisante d'une personnalité audacieuse grâce aux découpes laser puissantes et précises qui allègent le métal de l'abat-jour et créent un intrigant jeu de lumière et d'ombres. *Kelly* est une famille polyédrique de suspensions qui se distingue avec élégance dans toutes les pièces de vie grâce à la variété de formes et de finitions disponibles. ● FR

Verführerische Schönheit mit gewagter Persönlichkeit, die durch starke und genaue Laserschnitte zum Ausdruck gebracht wird, die das Metall des Lampenschirms leicht erscheinen lassen und ein betrügerisches Spiel aus Licht und Schatten schaffen. *Kelly* ist eine vielseitige Familie aus Hängeleuchten, die sich durch Eleganz in jedem Wohnraum auszeichnet, die den verschiedenen verfügbaren Formen und Ausführungen zu verdanken ist. ● DE

Una belleza seductora con una personalidad atrevida gracias a fuertes y precisos cortes de láser que aligeran el metal de la pantalla y crean un intrigante juego de luces y sombras. *Kelly* es una familia versátil de lámparas de suspensión que destaca con elegancia en cualquier entorno residencial gracias a la variedad de formas y acabados disponibles. ● ES

Соблазнительная красота с решительным характером создана благодаря четким и выразительным прорезам, выполненным методом лазерной резки, которые облегчают металлический абажур и создают интригующую игру света и тени. *Kelly* – это семейство универсальных подвесных светильников, которые элегантно украшают любой жилой интерьер благодаря разнообразию доступных форм и отделки. ● RU

强劲而精确的激光切割使灯罩的金属发亮，并创造出有趣的光影效果，具有诱人的美感和大胆个性。*Kelly* 是一个悬吊式系列的产品，其多种多样的外形和颜色使其在任何生活环境中均格外高雅。● ZH

Kelly small dome 50 ▾ Suspension lamp



Kelly small sphere 40 ▾ Suspension lamp

Kelly medium dome 60 ▾ Suspension lamp

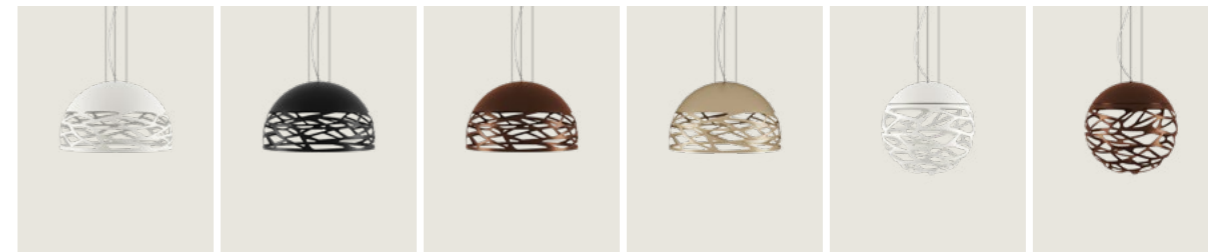

Kelly medium sphere 50 ▾ Suspension lamp

Kelly large dome 80 ▾ Suspension lamp



Kelly large sphere 80 ▾ Suspension lamp

CATEGORY **SUSPENSION LAMP**

**Kelly small dome 50**

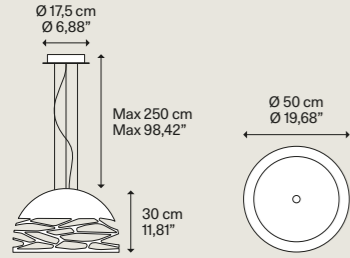

Net weight 6,00 kg / 13,23 lbs  
Pack Colli 1

DESIGN **Andrea Tosetto, 2015**

Metal structure Montatura in metallo	Glass diffuser Diffusore in vetro	Code Codice
Matte White - 9010 Bianco Opaco - 9010		14126 1000
Matte Black - 9005 Nero Opaco - 9005		14126 2000
Coppery Bronze Bronzo Ramato	Glossy White Bianco Lucido	14126 3500
Champagne Champagne		14126 4500

**Light source  
Sorgente luminosa**  
**E27 LED  
3x 25 W** W/L max 12 cm  
W/L max 4,72"  
Bulb not included  
Lampadina non inclusa

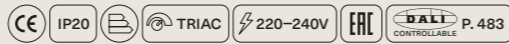

CATEGORY **SUSPENSION LAMP**

**Kelly small sphere 40**

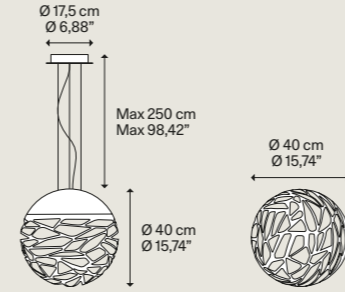

Net weight 5,50 kg / 12,13 lbs  
Pack Colli 2

DESIGN **Andrea Tosetto, 2015**

Metal structure Montatura in metallo	Glass diffuser Diffusore in vetro	Code Codice
Matte White - 9010 Bianco Opaco - 9010		14122 1000
Coppery Bronze Bronzo Ramato	Glossy White Bianco Lucido	14122 3500

**Light source  
Sorgente luminosa**  
**E27 LED  
3x 25 W** W/L max 12 cm  
W/L max 4,72"  
Bulb not included  
Lampadina non inclusa

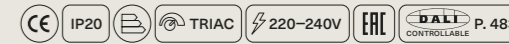

**Kelly medium dome 60**

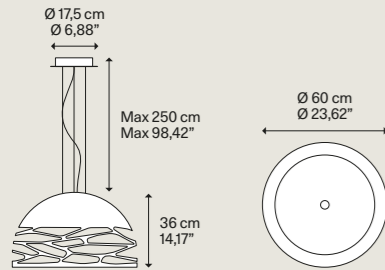

Net weight 7,15 kg / 15,75 lbs  
Pack Colli 1

Metal structure Montatura in metallo	Glass diffuser Diffusore in vetro	Code Codice
Matte White - 9010 Bianco Opaco - 9010		14127 1000
Matte Black - 9005 Nero Opaco - 9005		14127 2000
Coppery Bronze Bronzo Ramato	Glossy White Bianco Lucido	14127 3500
Champagne Champagne		14127 4500

**Light source  
Sorgente luminosa**  
**E27 LED  
3x 25 W** W/L max 12 cm  
W/L max 4,72"  
Bulb not included  
Lampadina non inclusa

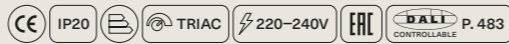

**Kelly medium sphere 50**

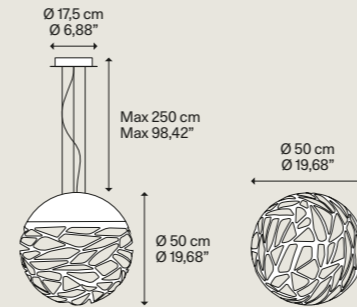

Net weight 9,00 kg / 19,84 lbs  
Pack Colli 2

Metal structure Montatura in metallo	Glass diffuser Diffusore in vetro	Code Codice
Matte White - 9010 Bianco Opaco - 9010		14123 1000
Coppery Bronze Bronzo Ramato	Glossy White Bianco Lucido	14123 3500

**Light source  
Sorgente luminosa**  
**E27 LED  
3x 25 W** W/L max 12 cm  
W/L max 4,72"  
Bulb not included  
Lampadina non inclusa

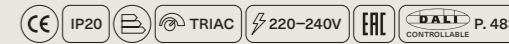

**Kelly large dome 80**

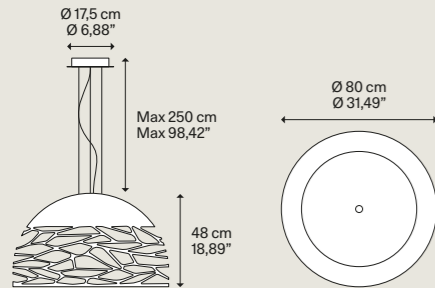

Net weight 11,00 kg / 24,25 lbs  
Pack Colli 1

Metal structure Montatura in metallo	Glass diffuser Diffusore in vetro	Code Codice
Matte White - 9010 Bianco Opaco - 9010		14128 1000
Matte Black - 9005 Nero Opaco - 9005		14128 2000
Coppery Bronze Bronzo Ramato	Glossy White Bianco Lucido	14128 3500
Champagne Champagne		14128 4500

**Light source  
Sorgente luminosa**  
**E27 LED  
4x 25 W** W/L max 12 cm  
W/L max 4,72"  
Bulb not included  
Lampadina non inclusa



**Kelly large sphere 80**

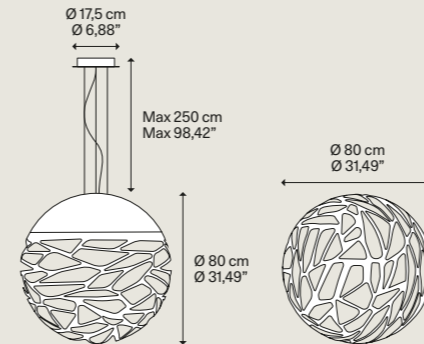

Net weight 15,00 kg / 33,07 lbs  
Pack Colli 2

Metal structure Montatura in metallo	Glass diffuser Diffusore in vetro	Code Codice
Matte White - 9010 Bianco Opaco - 9010		14124 1000
Coppery Bronze Bronzo Ramato	Glossy White Bianco Lucido	14124 3500

**Light source  
Sorgente luminosa**  
**E27 LED  
4x 25 W** W/L max 12 cm  
W/L max 4,72"  
Bulb not included  
Lampadina non inclusa

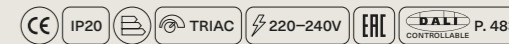



## Standard Bespoke

*Lodes* provides functional and decorative solutions that offer endless possibilities for customisation through the combination of lamps and canopies. The freedom offered by these combinations brings to life the concept of “*Standard Bespoke*”: a collection of products which are universal, meeting the specific needs of any living spaces, thanks to the possibility of configuring unique and meaningful compositions at will.

*Lodes* consente di creare soluzioni funzionali e decorative che offrono infinite possibilità di personalizzazione grazie all'unione tra lampade e rosoni. La grande libertà offerta da queste combinazioni dà vita al concetto di “*Standard Bespoke*”: una collezione dal carattere universale, in grado di rispondere alle esigenze specifiche di ogni spazio grazie alla possibilità di configurare a piacere composizioni uniche e dense di significato.

# Standard Bespoke



Type of canopy: *Recessed Micro* and *Recessed Micro Trimless* (Pure and Deep)  
Finishes: Clear, Frosted White and Glossy Smoke

Random Solo, design by Chia-Ying Lee

## Cluster suspension lamps

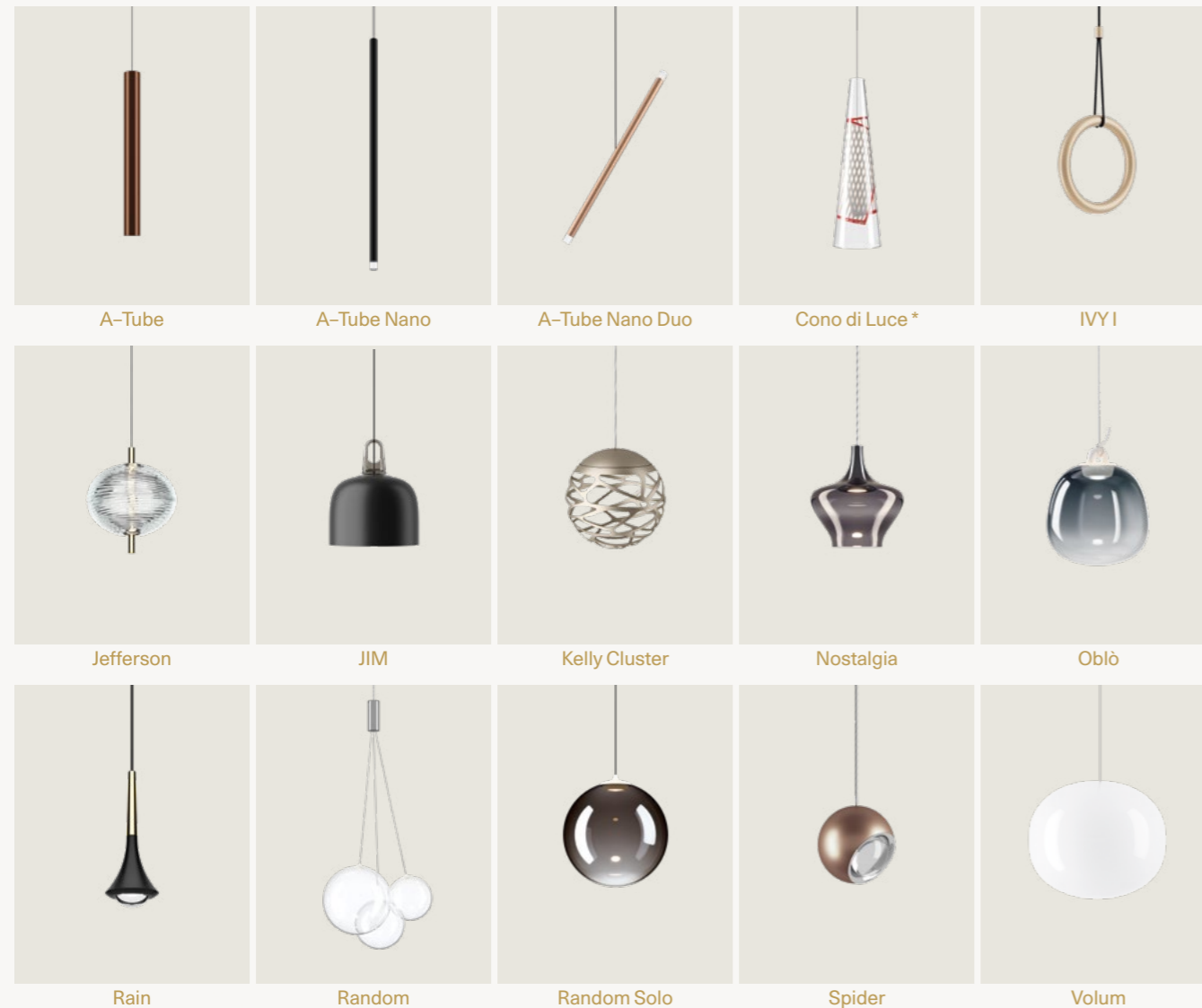

## Single canopies



*Single canopies* are ideal for highlighting the corner of a room or enhancing single light sources. They can also be used to create multiple custom combinations on high ceilings or in spaces which do not allow lights to be grouped in a cluster.

I *rosoni singoli* permettono di mettere in luce gli angoli di una stanza o di valorizzare le singole lampade; possono anche essere utilizzati per creare composizioni multiple e personalizzate su soffitti molto alti o in situazioni che non consentono l'utilizzo di cluster.

## Multiple canopies

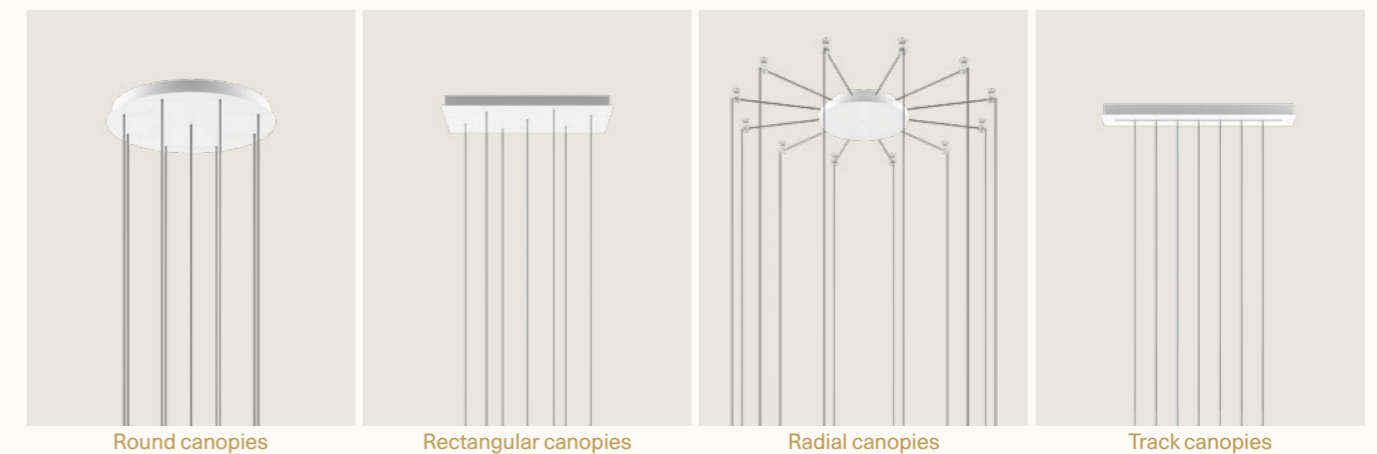

*Multiple canopies* are the ideal solution for functional and decorative lighting; *round* or *rectangular*, they allow the creation of impactful lighting compositions. *Radial systems* are an innovative solution to separately manage various suspension cables with one single canopy. *Track systems* offer various possibilities for configuration, from aligned to staggered suspended solutions.

I *rosoni multipli* sono la soluzione ideale per un'illuminazione funzionale e decorativa; *rotondi* o *rettangolari*, permettono di creare composizioni sospese di grande impatto. I *sistemi radiali* sono una soluzione innovativa per gestire separatamente più cavi di sospensione con un unico rosone. I *sistemi a binario* offrono numerose possibilità di configurazione, per soluzioni sospese allineate in altezza o sfalsate.



# Create Bespoke compositions with Lodes' canopies!



Random Solo, 5 Lights Round

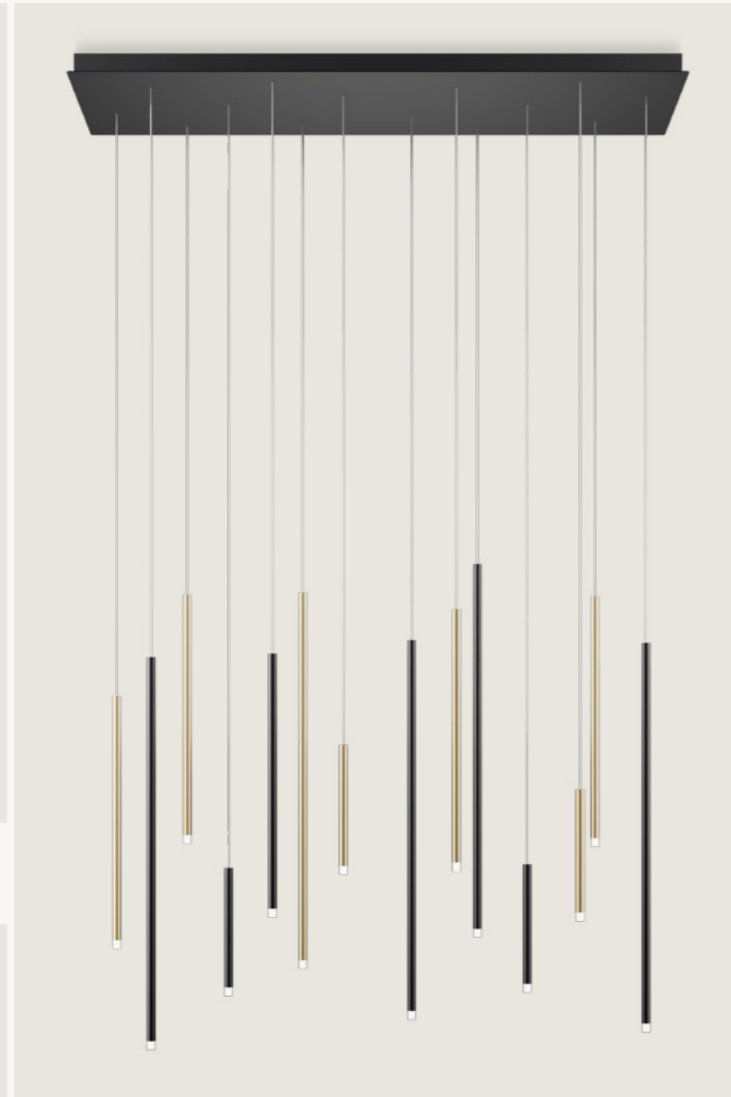

A-Tube Nano, 14 Lights Rectangular



Nostalgia, 7 Lights Rectangular

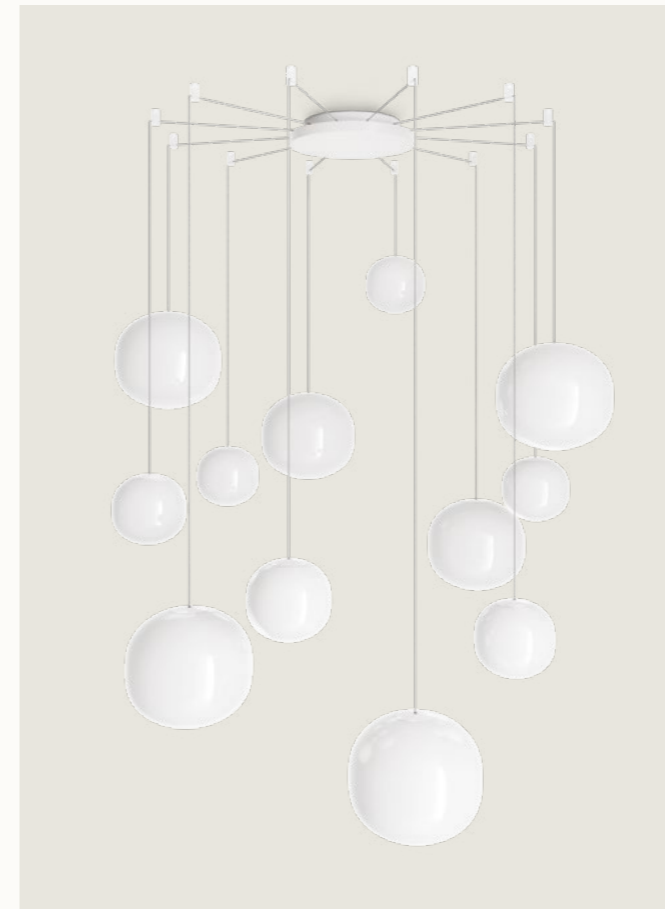

Volum, 12 Lights Radial



Kelly Cluster, Short Lights Track



Random, Long Lights Track



Jefferson, Single Mini

# Welcome to the *Lodes* product Configurator

Discover the online configurator now!



Set and view your composition

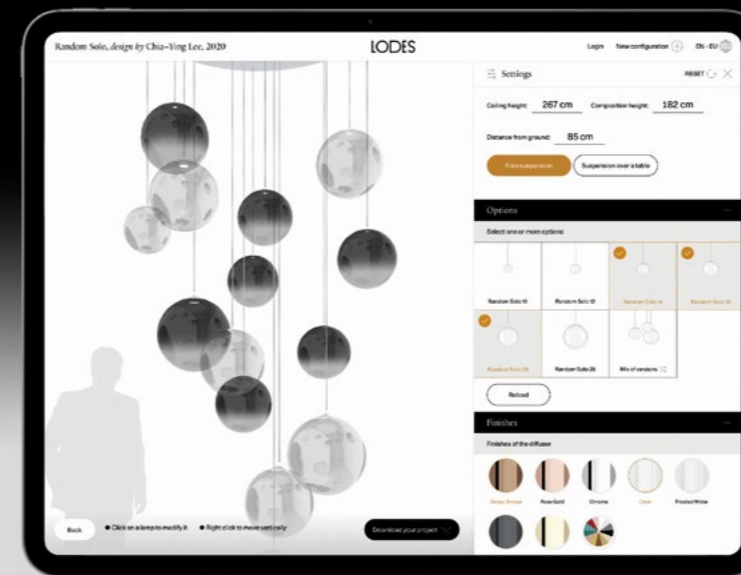

- 1 Set the dimensions
- 2 Choose the finishes
- 3 View your configuration
- 4 Click on a lamp to modify it
- 5 Click to explore the composition

Welcome to the Lodes product configurator!

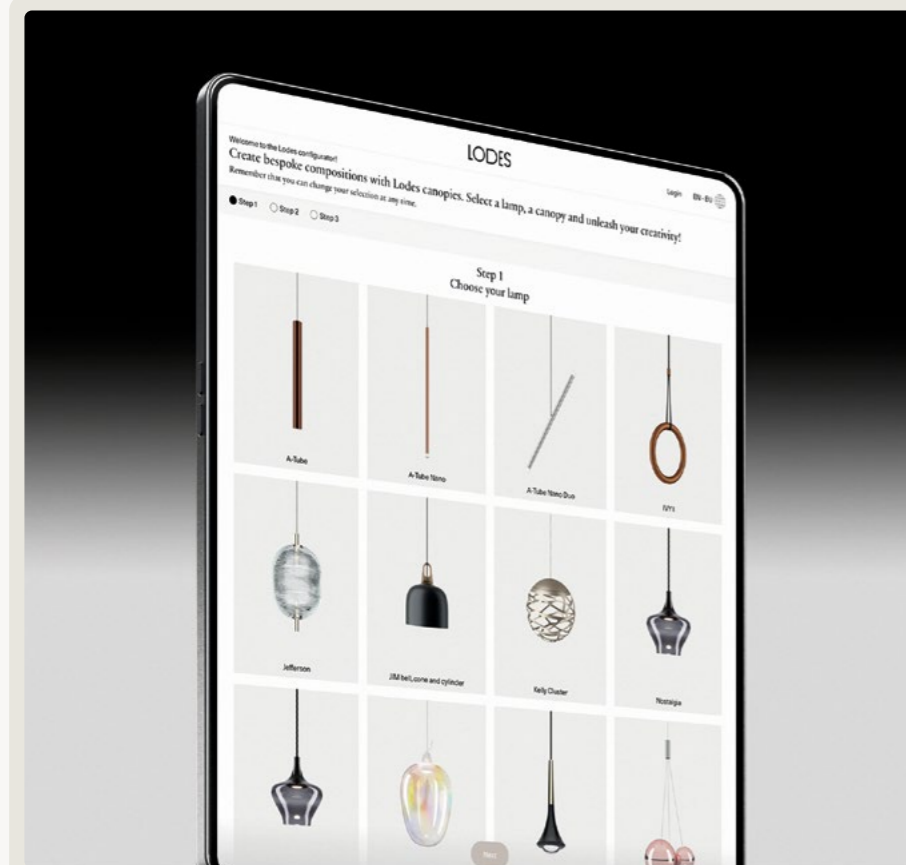

- 1 Choose your lamp
- 2 Choose size and finish of your canopy
- 3 Confirm your ceiling height and decide your composition type
- 5 Start configuring!

Download your project and get a quote

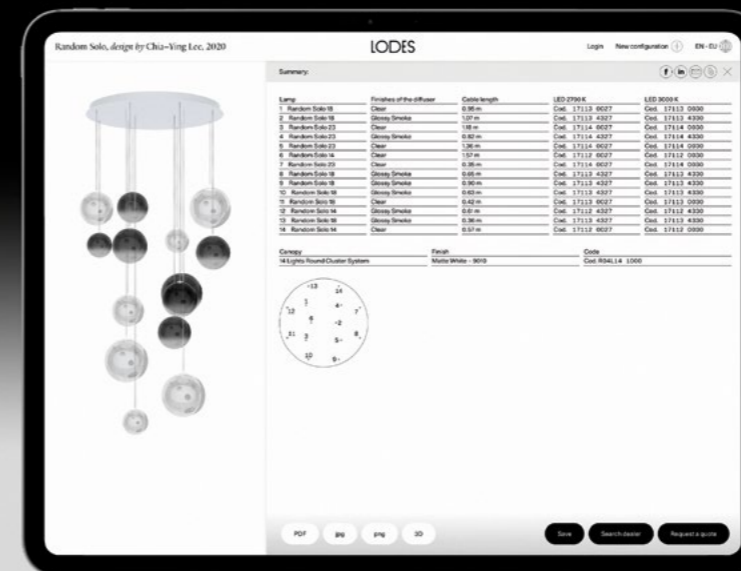

- 1 Download PDF, jpg, png, 3D
- 2 Save your configuration
- 3 Search dealer
- 4 Request a quote



Lodes' *product configurator* offers endless opportunities to create personalised canopy lighting. By following a few simple steps – such as selecting a *suspension lamp* and a *canopy* of your choice – it allows to create a unique piece that meets the needs of the space and the desires of the user.

Il *configuratore di prodotto* Lodes offre infinite possibilità per un'illuminazione personalizzata. Seguendo pochi, semplici passaggi – come selezionare una *lampada* a sospensione e un *rosone* a scelta – permette di configurare un pezzo unico in grado di soddisfare le esigenze dello spazio e i desideri dell'utente.

# Lodes' Online Configurator

Lodes Configurator  
Create your configuration





# Oblò

Designed by Paola Navone – OTTO Studio Year 2024

*Oblò* is a suspension lamp with a strong decorative character, offering fresh insights into the use of Pyrex in lighting while expanding *Lodes'* aesthetic vocabulary with the delicate sensitivity of Paola Navone – OTTO Studio. The product's soft silhouette and the five chosen shades for the finishes evoke marine imagery and reflections of light on water. The knotted canvas cable on the hook supporting the diffuser creates the illusion that the lamp floats in the air like a buoy. The LED light source and the electrical cable that powers it are concealed, making only the glass visible, just like looking through a porthole. Available in three gentle forms, *Oblò* offers lighting solutions capable of creating different movements and rhythms, alone or in compositions, to illuminate and decorate a wide range of spaces.

*Oblò* è una lampada a sospensione dal carattere fortemente decorativo che offre nuovi spunti sull'utilizzo del Pyrex nell'illuminazione e amplia il vocabolario estetico di *Lodes* con la delicata sensibilità di Paola Navone – OTTO Studio. La silhouette morbida del prodotto e le cinque sfumature scelte per le finiture evocano l'immaginario marino e i riflessi di luce sull'acqua, mentre il cavo telato annodato al gancio che sostiene il diffusore crea l'illusione che la lampada galleggi nell'aria come una boa. La sorgente luminosa LED è nascosta, così come il cavo elettrico che la alimenta: in questo modo si vede solo il vetro, proprio come guardando attraverso un oblò. Disponibile in tre forme dalle linee gentili, *Oblò* offre soluzioni di luce in grado di creare movimenti e ritmi diversi, da sola o in composizione, per illuminare e decorare una vasta gamma di ambienti.

Go to the technical info 

Click to discover more 

Oblò  
COD. 218

CATEGORY LAMP

TYPE OF LIGHT

Cluster suspension

Sospensione cluster

Diffused light

Luce diffusa



NEW LAMP











Oblò small and large, FINISHES Azure Steel and Clear.

Oblò, FINISH Silk White.



Oblò large, medium and small, FINISHES Silk White, Clear and Glossy Smoke.



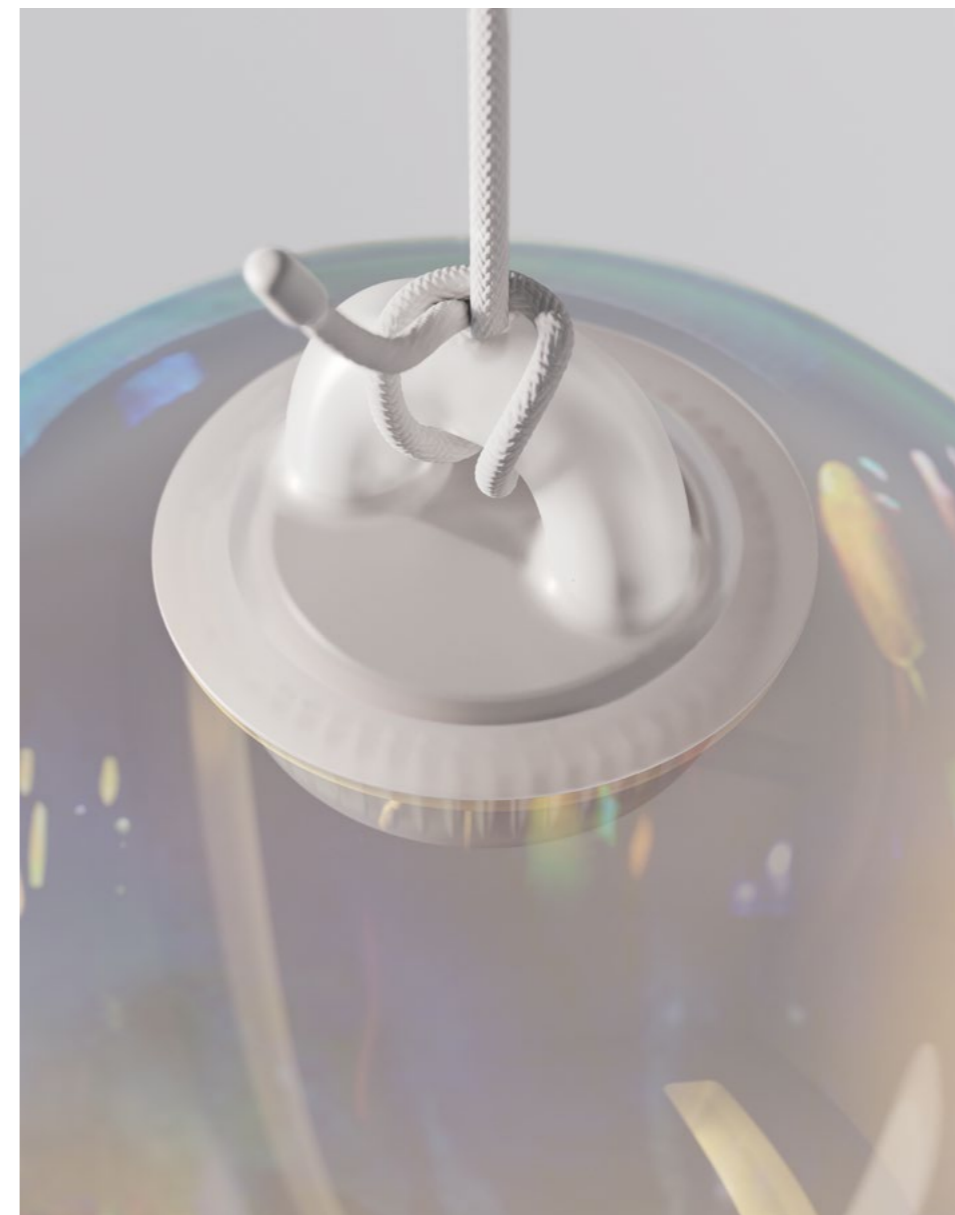





Oblò small, medium and large, FINISHES Clear and Silk White.





*Oblò* est une suspension au caractère hautement décoratif qui propose de nouvelles idées sur l'utilisation du Pyrex dans l'éclairage et enrichit le vocabulaire esthétique de *Lodes* avec la délicate sensibilité de Paola Navone - OTTO Studio. La douce forme de cet article et les cinq nuances choisies pour les finitions évoquent l'imaginaire du monde marin et les reflets de la lumière sur l'eau, tandis que le câble en toile noué au crochet qui soutient le diffuseur crée l'illusion que la suspension flotte dans les airs comme une bouée sur l'eau. La source lumineuse LED est dissimulée, tout comme le câble électrique qui l'alimente : ainsi, seul le verre est visible, comme s'il l'on regardait à travers un hublot. Disponible en trois formes aux lignes douces, *Oblò* propose des solutions d'éclairage en mesure de créer différents mouvements et rythmes, seule ou en composition, pour illuminer et décorer une vaste gamme d'ambiances. ● FR

*Oblò* ist eine Hängeleuchte mit stark dekorativem Charakter, die neue Einblicke in die Verwendung von Pyrex in der Beleuchtung bietet und das ästhetische Vokabular von *Lodes* mit der feinen Sensibilität von Paola Navone - OTTO Studio - erweitert. Die weiche Silhouette des Produkts und die fünf für die Ausführungen gewählten Farbtöne, erwecken Vorstellungen von Meeresmotiven und Lichtreflexen auf dem Wasser, während das geknotete Segeltuchkabel am Haken, der den Diffusor trägt, die Illusion erzeugt, dass die Leuchte wie eine Boje in der Luft schwebt. Das LED-Leuchtmittel ist verdeckt, ebenso wie das zugehörige Stromkabel: auf diese Weise ist nur das Glas zu sehen, genauso wie beim Blick durch ein Bullauge. *Oblò* ist in drei Formen mit sanften Linien erhältlich und bietet Beleuchtungslösungen, die in der Lage sind, einzeln oder in Komposition verschiedene Bewegungen und Rhythmen zu erzeugen, um eine Vielzahl von Ambiente zu beleuchten und zu dekorieren. ● DE

*Oblò* es una lámpara de suspensión con un gran carácter decorativo que ofrece nuevas ideas acerca de la utilización del Pyrex en la iluminación y amplía el vocabulario estético de *Lodes* con la delicada sensibilidad de Paola Navone - OTTO Studio. La suave silueta del producto y los cinco tonos elegidos para los acabados evocan el imaginario marino y los reflejos de luz sobre el agua, mientras el cable revestido de tela anudado en el gancho que sostiene el difusor hace creer que la lámpara flote en el aire como una boya. La fuente luminosa LED está oculta, del mismo modo que el cable eléctrico que la alimenta: de esta forma sólo se ve el vidrio, del mismo modo que cuando se mira a través de una claraboya. Disponible en tres formas de líneas suaves, *Oblò* ofrece soluciones de luz capaces de crear movimientos y ritmos distintos, por sí sola o como parte de una composición, para iluminar y decorar una amplia gama de ambientes. ● ES

*Oblò* - это подвесной светильник с выраженным декоративным характером, предлагающий новые идеи для применения стекла Pyrex в освещении и расширяющий эстетическую гамму *Lodes* тонкой чувствительностью Паолы Навоне - OTTO Studio. Мягкий силуэт светильника и выбранные для отделки пять оттенков навевают морские образы и отражения света на воде, а обтянутый тканью трос, завязанный на крюке, поддерживающем диффузор, создает иллюзию, будто светильник парит в воздухе, как буй. Светодиодный источник света скрыт, как и питающий его электрический кабель: таким образом видно только стекло, как если бы вы смотрели в иллюминатор. Светильник *Oblò*, доступный в трех формах, отличающихся плавными линиями, предлагает световые решения, способные создавать различные движения и ритмы, по отдельности или в композиции, освещая и украшая самые разнообразные помещения. ● RU

*Oblò* 是一款具有高度装饰性的吊灯,它为派热克斯玻璃在照明中的使用提供了新的见解并通过OTTO工作室的 Paola Navone 那细腻敏感度而扩展了 *Lodes* 的审美词汇。这款产品的柔和轮廓和饰面的五种精选调色板让人忆起海洋的画面以及水面上的光线反射,而打结在挂钩上用来支撑灯罩的帆布绳则营造出灯件如同浮标一般漂浮在空中的错觉。LED光源和为其供电的线缆都是隐匿的:如此一来我们只能看到玻璃,就像透过舷窗观望一般。共有三种线条柔和的可选形状,*Oblò* 提供能够以单独或组合方式创造不同运动和节奏的灯光解决方案,以照亮并装饰各种环境。● ZH

Oblò small » Cluster suspension lamp **NEW LAMP**

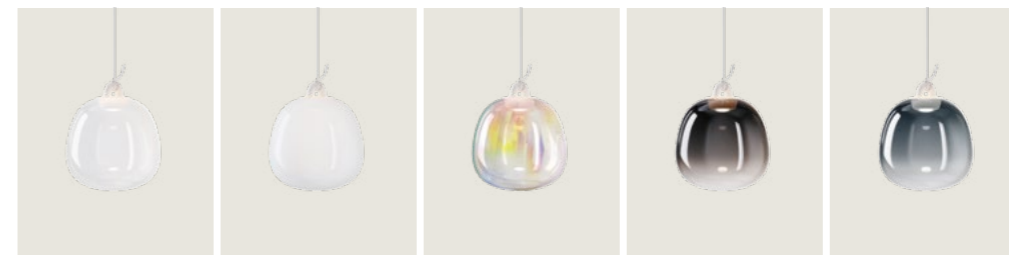

Oblò medium » Cluster suspension lamp **NEW LAMP**

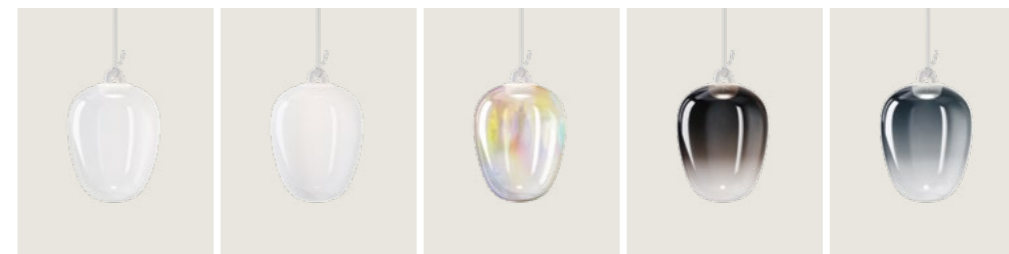

Oblò large » Cluster suspension lamp **NEW LAMP**

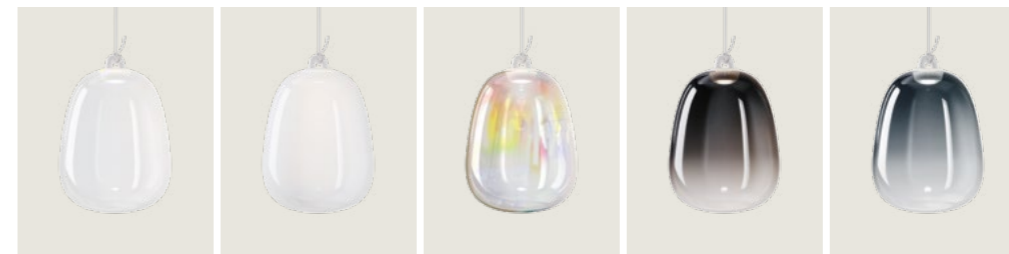

CATEGORY CLUSTER SUSPENSION LAMP **NEW LAMP**

DESIGN Paola Navone – OTTO Studio, 2024

### Oblò small

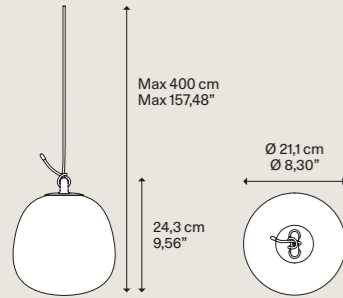

<b>Silicone hook</b> Gancio in silicone	<b>White</b> Bianco
<b>White fabric cable</b> Cavo bianco in tessuto	

<b>Blown glass diffuser</b> Diffusore in vetro soffiato	<b>Code</b> Codice	<b>Code</b> Codice
Clear Trasparente	21811 0027	21811 0030
Silk White NEW Bianco Seta	21811 1327	21811 1330
Rainbow NEW Iridescente	21811 0127	21811 0130
Glossy Smoke Fumo Lucido	21811 4327	21811 4330
Azure Steel NEW Azzurro Metallizzato	21811 8627	21811 8630

<b>Light source</b> Sorgente luminosa	<b>LED</b>
2700	K
7	W
1280	lm
350	mA
CRI 90	
MacAdam 3-Step	
LED and driver included LED e driver inclusi	

<b>Light source</b> Sorgente luminosa	<b>LED</b>
3000	K
7	W
1300	lm
350	mA
CRI 90	
MacAdam 3-Step	
LED and driver included LED e driver inclusi	

Net weight Peso netto	0,64 kg 1,41 lbs	Pack Colli	2	Energy class Classe energetica	D
--------------------------	---------------------	---------------	---	-----------------------------------	---

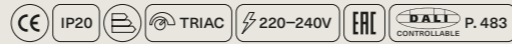

CATEGORY CLUSTER SUSPENSION LAMP **NEW LAMP**

DESIGN Paola Navone – OTTO Studio, 2024

### Oblò large

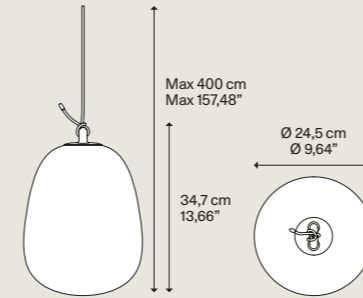

<b>Silicone hook</b> Gancio in silicone	<b>White</b> Bianco
<b>White fabric cable</b> Cavo bianco in tessuto	

<b>Blown glass diffuser</b> Diffusore in vetro soffiato	<b>Code</b> Codice	<b>Code</b> Codice
Clear Trasparente	21813 0027	21813 0030
Silk White NEW Bianco Seta	21813 1327	21813 1330
Rainbow NEW Iridescente	21813 0127	21813 0130
Glossy Smoke Fumo Lucido	21813 4327	21813 4330
Azure Steel NEW Azzurro Metallizzato	21813 8627	21813 8630

<b>Light source</b> Sorgente luminosa	<b>LED</b>
2700	K
7	W
1280	lm
350	mA
CRI 90	
MacAdam 3-Step	
LED and driver included LED e driver inclusi	

<b>Light source</b> Sorgente luminosa	<b>LED</b>
3000	K
7	W
1300	lm
350	mA
CRI 90	
MacAdam 3-Step	
LED and driver included LED e driver inclusi	

Net weight Peso netto	0,82 kg 1,80 lbs	Pack Colli	2	Energy class Classe energetica	D
--------------------------	---------------------	---------------	---	-----------------------------------	---

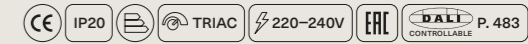

Cluster suspension lamps must be installed on a canopy ▶ P. 318–327  
Le lampade a sospensione cluster devono essere installate su rosone ▶ P. 318–327

**NEW LAMP**

### Oblò medium

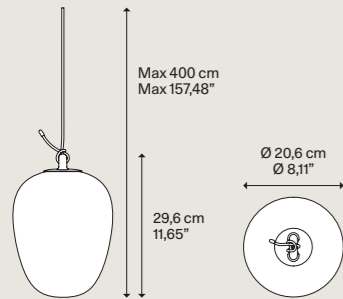

<b>Silicone hook</b> Gancio in silicone	<b>White</b> Bianco
<b>White fabric cable</b> Cavo bianco in tessuto	

<b>Blown glass diffuser</b> Diffusore in vetro soffiato	<b>Code</b> Codice	<b>Code</b> Codice
Clear Trasparente	21812 0027	21812 0030
Silk White NEW Bianco Seta	21812 1327	21812 1330
Rainbow NEW Iridescente	21812 0127	21812 0130
Glossy Smoke Fumo Lucido	21812 4327	21812 4330
Azure Steel NEW Azzurro Metallizzato	21812 8627	21812 8630

<b>Light source</b> Sorgente luminosa	<b>LED</b>
2700	K
7	W
1280	lm
350	mA
CRI 90	
MacAdam 3-Step	
LED and driver included LED e driver inclusi	

<b>Light source</b> Sorgente luminosa	<b>LED</b>
3000	K
7	W
1300	lm
350	mA
CRI 90	
MacAdam 3-Step	
LED and driver included LED e driver inclusi	

Net weight Peso netto	0,69 kg 1,52 lbs	Pack Colli	2	Energy class Classe energetica	D
--------------------------	---------------------	---------------	---	-----------------------------------	---

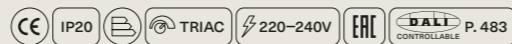

Cluster suspension lamps must be installed on a canopy ▶ P. 318–327  
Le lampade a sospensione cluster devono essere installate su rosone ▶ P. 318–327



# Random Solo

Designed by Chia-Ying Lee

Year 2020, 2024

Six perfect spheres floating in the air like gentle glass bubbles. *Random Solo* revisits the concept of the *Random* suspension lamp by parting the original three-piece cluster and releasing the individuality of the spherical shapes, which float like bubbles of light, letting you imagine compositions of luminous harmonies. Thanks to the new 10 cm size, there are now six dimensions and seven different finishes available, offering ample styling freedom, both as individually suspended light points and in lightweight and lively combinations on clusters.

Sei sfere perfette che fluttuano nell'aria come leggere bolle di vetro. *Random Solo* rivisita il concetto della lampada a sospensione *Random*, separando l'originale cluster a tre elementi e liberando l'individualità delle forme sferiche, che fluttuano come bolle di luce lasciando immaginare composizioni di armonie luminose. Grazie alla nuova sfera da 10 cm, sono ora sei le dimensioni e sette le finiture disponibili, offrendo ampia libertà di arredamento, sia come punti luce sospesi singolarmente che in leggere e vivaci composizioni multiple su cluster.



[Go to the technical info](#) 
[Click to discover more](#) 

Random Solo  
COD. 171

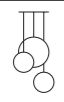
CATEGORY LAMP		TYPE OF LIGHT	
Cluster suspension	Sospensione cluster	Diffused light	Luce diffusa
			



106 Random Solo 23 and 28, composition of 14 lights on a *round canopy*, FINISHES Clear and Glossy Smoke.



Random Solo, FINISHES Glossy Smoke and Clear.





















Random Solo 23, composition of 4 lights on a *long track*, FINISH Frosted White.

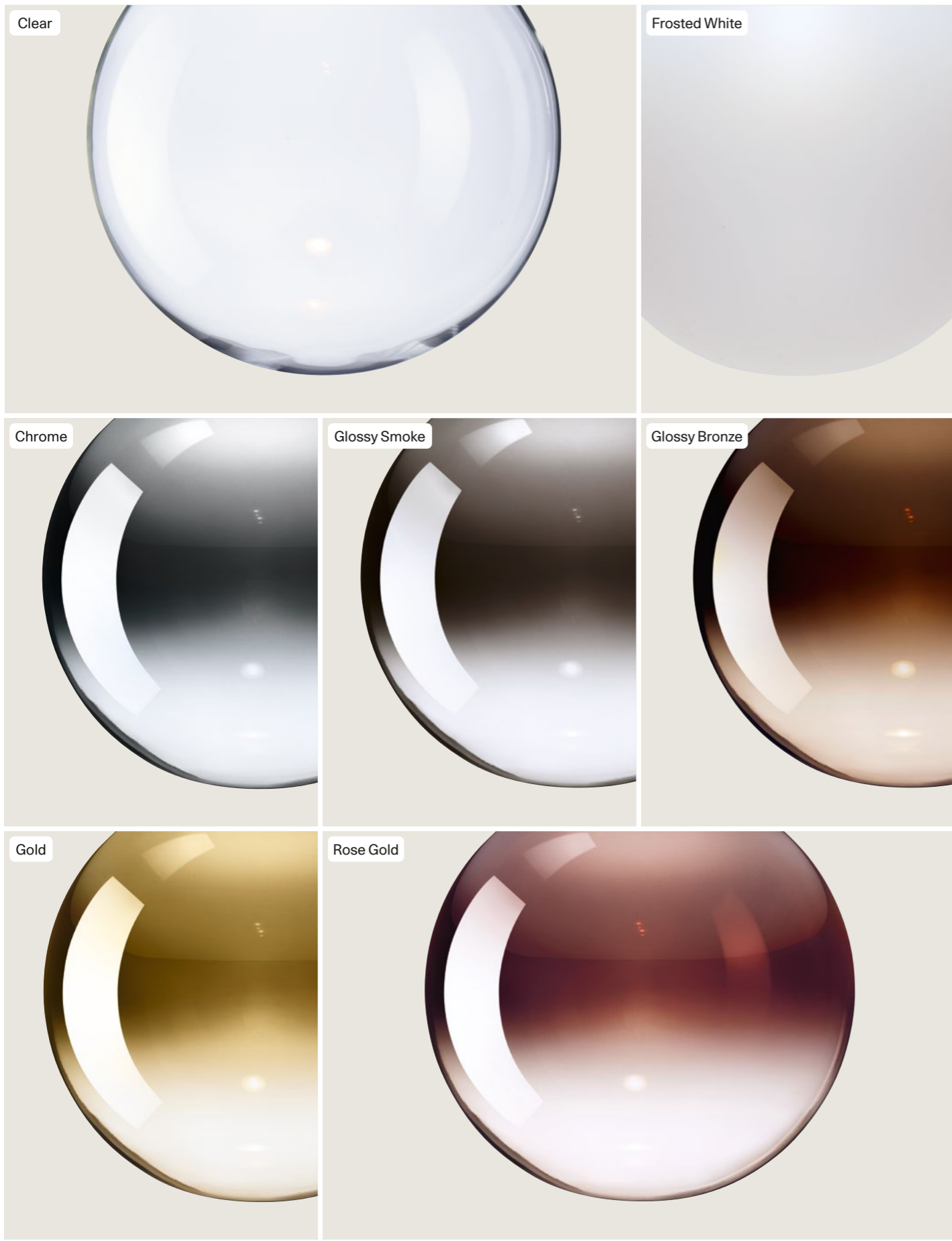

Six sphères parfaites flottant dans l'air comme de suaves bulles de verre. *Random Solo* revisite le concept de la suspension *Random* en séparant le cluster original de trois pièces et en libérant l'individualité des formes sphériques qui fluctuent comme des bulles de lumière faisant imaginer des compositions d'harmonies lumineuses. Avec la nouvelle sphère de 10 cm, nous sommes ravis de pouvoir proposer six tailles et sept finitions pour une grande liberté d'ameublement, tant comme points lumineux suspendus individuellement qu'en combinaisons légères et animées en cluster. ●FR

Sechs perfekte Kugeln, die wie leichte Glasblasen in der Luft schweben. *Random Solo* überarbeitet das Konzept der Hängeleuchte *Random*, für das das Original-Cluster mit drei Elementen aufgeteilt wurde, und die Individualität der sphärischen Formen freisetzt, die wie Lichtblasen schweben und Kompositionen aus leuchtenden Harmonien erahnen lassen. Dank der neuen 10-cm-Kugel stehen nun sechs Größen und sieben verschiedene Ausführungen zur Verfügung, die eine große Gestaltungsfreiheit bieten, sowohl als einzeln aufgehängte Lichtpunkte als auch in leichten und lebhaften Kombinationen auf Clustern. ●DE

Seis esferas perfectas que flotan en el aire como delicadas burbujas de vidrio. *Random Solo* reexamina el concepto de la lámpara de suspensión *Random* separando el grupo de lámparas de suspensión original y liberando la individualidad de las formas esféricas que flotan como burbujas de luz y dejan imaginar composiciones de armonías luminosas. Gracias a la nueva esfera de 10 cm, ahora hay seis tamaños y siete acabados disponibles que ofrecen una amplia libertad de decoración, tanto como puntos de luz suspendidos individualmente como en composiciones múltiples ligeras y alegres en grupos de lámparas de suspensión. ●ES

Шесть идеальных сфер, парящих в воздухе подобно нежным стеклянным пузырям. *Random Solo* по-новому осмысливает концепцию подвесного светильника *Random*, разделяя оригинальный кластер, состоящий из трех частей, и освобождая индивидуальность сферических форм, парящих как светящиеся шары и вызывая в воображении гармоничные световые композиции. Благодаря новой сфере размером 10 см, предлагаются шесть размеров и семь отделок, гарантируя огромную свободу по оформлению декора, как в качестве индивидуально подвешенных световых точек, так и в легких и ярких комбинациях в кластерах. ●RU

六个完美的球体就像柔和的玻璃泡泡一般漂浮于中。*Random Solo*重新审视了 *Random* 悬吊灯的理念,将最初的三件式底盘分开而来并为球体形状留下了更多的个体空间,这些球体像光的泡泡一样漂浮着,令人联想至光影交融的和谐组合。得益于10厘米的全新球体,六种尺寸和七种饰面如今提供充足的造型自由度,既可作为单独悬吊的照明点,亦可作为轻盈活泼的底盘组合。●ZH



Random Solo 10 Cluster suspension lamp

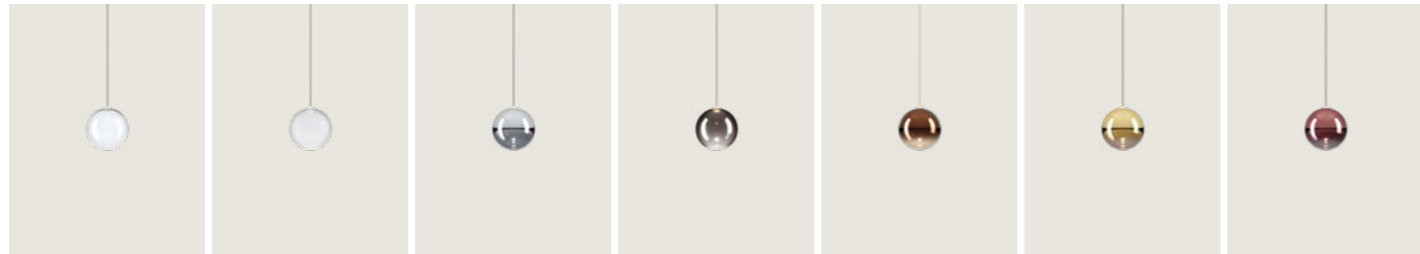

Random Solo 12 Cluster suspension lamp

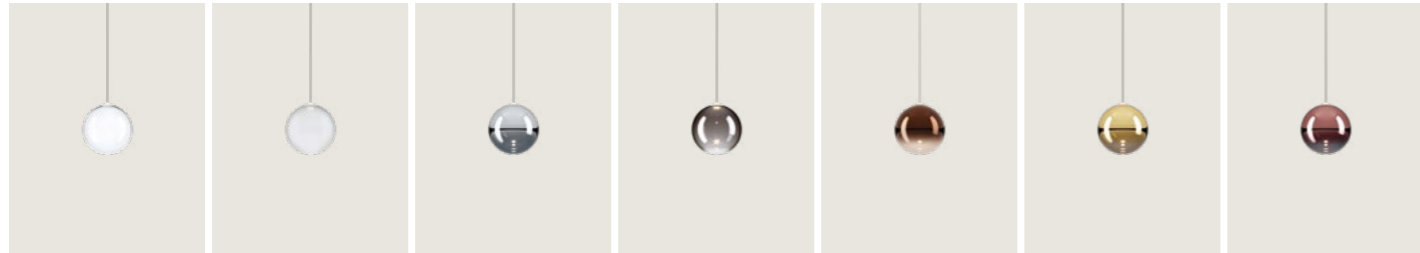

Random Solo 14 Cluster suspension lamp

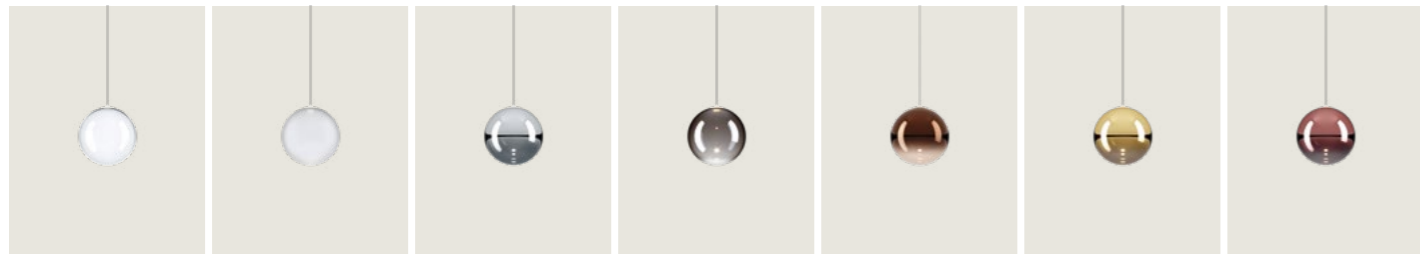

Random Solo 18 Cluster suspension lamp

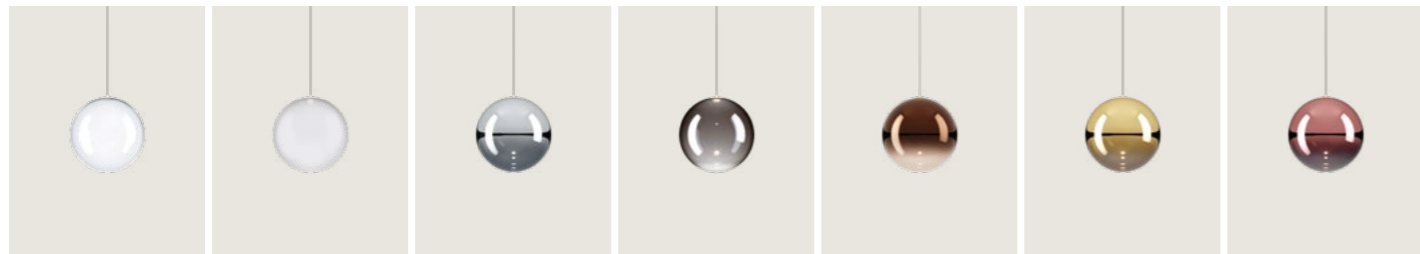

Random Solo 23 Cluster suspension lamp

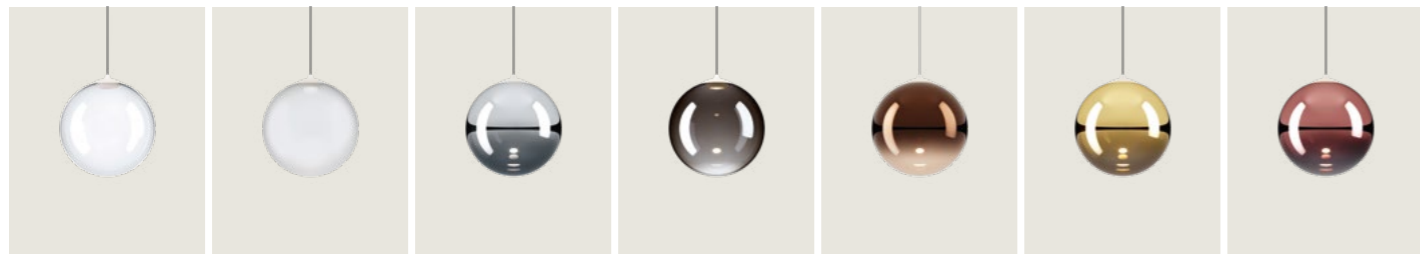

Random Solo 28 Cluster suspension lamp

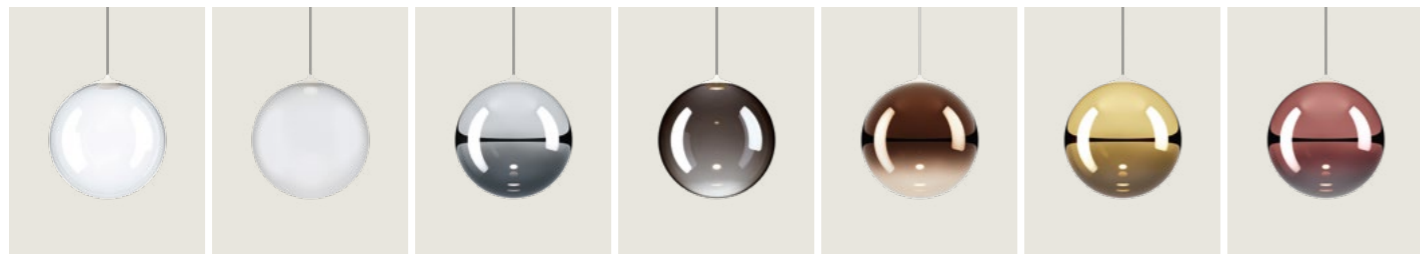

CATEGORY CLUSTER SUSPENSION LAMP

Random Solo 10

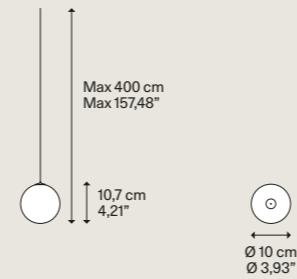

DESIGN Chia-Ying Lee, 2024

Blown glass diffuser Diffusore in vetro soffiato	Code Codice <sup>A</sup>	Code Codice <sup>B</sup>
Clear Trasparente	17110 0027	17110 0030
Frosted White Bianco Satinato	17110 1327	17110 1330
Chrome Cromo	17110 4027	17110 4030
Glossy Smoke Fumo Lucido	17110 4327	17110 4330
Glossy Bronze Bronzo Lucido	17110 4627	17110 4630
Gold Oro	17110 5027	17110 5030
Rose Gold Oro Rosa	17110 5527	17110 5530

Light source  
Sorgente luminosa <sup>A</sup>

LED  
2700 K  
1 W  
150 lm  
350 mA  
CRI 90  
MacAdam 3-Step

LED and driver included  
LED e driver inclusi

Light source  
Sorgente luminosa <sup>B</sup>

LED  
3000 K  
1 W  
160 lm  
350 mA  
CRI 90  
MacAdam 3-Step

LED and driver included  
LED e driver inclusi

Net weight 0,165 kg / Peso netto 0,363 lbs | Pack Colli 2 | Energy class Classe energetica D

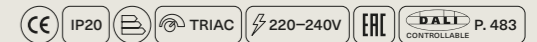

CATEGORY CLUSTER SUSPENSION LAMP

Random Solo 12

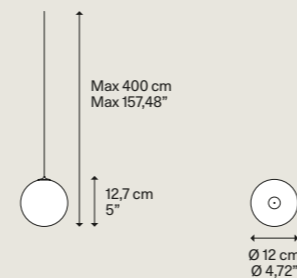

DESIGN Chia-Ying Lee, 2020

Blown glass diffuser Diffusore in vetro soffiato	Code Codice <sup>A</sup>	Code Codice <sup>B</sup>
Clear Trasparente	17111 0027	17111 0030
Frosted White Bianco Satinato	17111 1327	17111 1330
Chrome Cromo	17111 4027	17111 4030
Glossy Smoke Fumo Lucido	17111 4327	17111 4330
Glossy Bronze Bronzo Lucido	17111 4627	17111 4630
Gold Oro	17111 5027	17111 5030
Rose Gold Oro Rosa	17111 5527	17111 5530

Light source  
Sorgente luminosa <sup>A</sup>

LED  
2700 K  
1 W  
150 lm  
350 mA  
CRI 90  
MacAdam 3-Step

LED and driver included  
LED e driver inclusi

Light source  
Sorgente luminosa <sup>B</sup>

LED  
3000 K  
1 W  
160 lm  
350 mA  
CRI 90  
MacAdam 3-Step

LED and driver included  
LED e driver inclusi

Net weight 0,20 kg / Peso netto 0,44 lbs | Pack Colli 2 | Energy class Classe energetica D

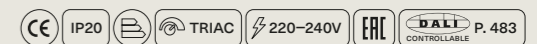

Cluster suspension lamps must be installed on a canopy ▶ P. 318-327  
Le lampade a sospensione cluster devono essere installate su rosone ▶ P. 318-327

CATEGORY CLUSTER SUSPENSION LAMP

DESIGN Chia-Ying Lee, 2020

### Random Solo 14

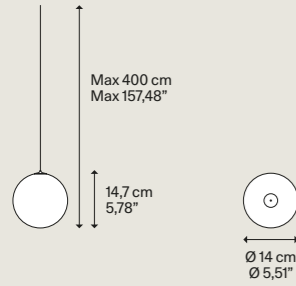

Blown glass diffuser Diffusore in vetro soffiato	Code Codice	A	Code Codice	B
Clear Trasparente	17112 0027		17112 0030	
Frosted White Bianco Satinato	17112 1327		17112 1330	
Chrome Cromo	17112 4027		17112 4030	
Glossy Smoke Fumo Lucido	17112 4327		17112 4330	
Glossy Bronze Bronzo Lucido	17112 4627		17112 4630	
Gold Oro	17112 5027		17112 5030	
Rose Gold Oro Rosa	17112 5527		17112 5530	

**Light source**  
Sorgente luminosa **A**

LED  
2700 K  
1 W  
150 lm  
350 mA  
CRI 90  
MacAdam 3-Step

LED and driver included  
LED e driver inclusi

**Light source**  
Sorgente luminosa **B**

LED  
3000 K  
1 W  
160 lm  
350 mA  
CRI 90  
MacAdam 3-Step

LED and driver included  
LED e driver inclusi

Net weight 0,22 kg / 0,48 lbs  
Pack Colli 2  
Energy class Classe energetica D

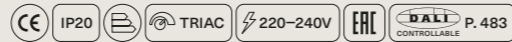

### Random Solo 18

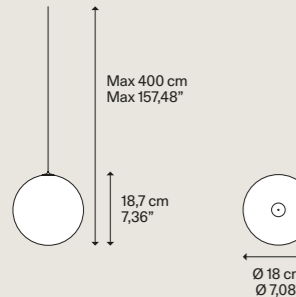

Blown glass diffuser Diffusore in vetro soffiato	Code Codice	A	Code Codice	B
Clear Trasparente	17113 0027		17113 0030	
Frosted White Bianco Satinato	17113 1327		17113 1330	
Chrome Cromo	17113 4027		17113 4030	
Glossy Smoke Fumo Lucido	17113 4327		17113 4330	
Glossy Bronze Bronzo Lucido	17113 4627		17113 4630	
Gold Oro	17113 5027		17113 5030	
Rose Gold Oro Rosa	17113 5527		17113 5530	

**Light source**  
Sorgente luminosa **A**

LED  
2700 K  
1 W  
150 lm  
350 mA  
CRI 90  
MacAdam 3-Step

LED and driver included  
LED e driver inclusi

**Light source**  
Sorgente luminosa **B**

LED  
3000 K  
1 W  
160 lm  
350 mA  
CRI 90  
MacAdam 3-Step

LED and driver included  
LED e driver inclusi

Net weight 0,35 kg / 0,77 lbs  
Pack Colli 2  
Energy class Classe energetica D

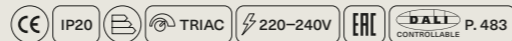

Cluster suspension lamps must be installed on a canopy ▶ p. 318–327  
Le lampade a sospensione cluster devono essere installate su rosone ▶ p. 318–327

CATEGORY CLUSTER SUSPENSION LAMP

DESIGN Chia-Ying Lee, 2020

### Random Solo 23

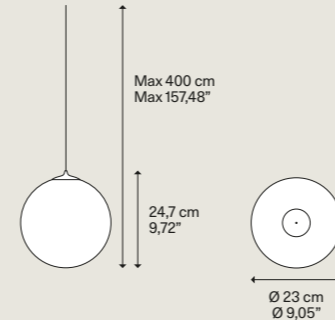

Blown glass diffuser Diffusore in vetro soffiato	Code Codice	A	Code Codice	B
Clear Trasparente	17114 0027		17114 0030	
Frosted White Bianco Satinato	17114 1327		17114 1330	
Chrome Cromo	17114 4027		17114 4030	
Glossy Smoke Fumo Lucido	17114 4327		17114 4330	
Glossy Bronze Bronzo Lucido	17114 4627		17114 4630	
Gold Oro	17114 5027		17114 5030	
Rose Gold Oro Rosa	17114 5527		17114 5530	

**Light source**  
Sorgente luminosa **A**

LED  
2700 K  
3 W  
450 lm  
350 mA  
CRI 90  
MacAdam 3-Step

LED and driver included  
LED e driver inclusi

**Light source**  
Sorgente luminosa **B**

LED  
3000 K  
3 W  
480 lm  
350 mA  
CRI 90  
MacAdam 3-Step

LED and driver included  
LED e driver inclusi

Net weight 0,60 kg / 1,32 lbs  
Pack Colli 2  
Energy class Classe energetica D

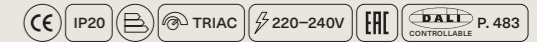

### Random Solo 28

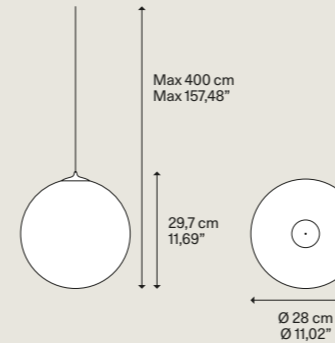

Blown glass diffuser Diffusore in vetro soffiato	Code Codice	A	Code Codice	B
Clear Trasparente	17115 0027		17115 0030	
Frosted White Bianco Satinato	17115 1327		17115 1330	
Chrome Cromo	17115 4027		17115 4030	
Glossy Smoke Fumo Lucido	17115 4327		17115 4330	
Glossy Bronze Bronzo Lucido	17115 4627		17115 4630	
Gold Oro	17115 5027		17115 5030	
Rose Gold Oro Rosa	17115 5527		17115 5530	

**Light source**  
Sorgente luminosa **A**

LED  
2700 K  
3 W  
450 lm  
350 mA  
CRI 90  
MacAdam 3-Step

LED and driver included  
LED e driver inclusi

**Light source**  
Sorgente luminosa **B**

LED  
3000 K  
3 W  
480 lm  
350 mA  
CRI 90  
MacAdam 3-Step

LED and driver included  
LED e driver inclusi

Net weight 0,90 kg / 1,98 lbs  
Pack Colli 2  
Energy class Classe energetica D

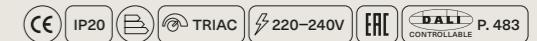

Cluster suspension lamps must be installed on a canopy ▶ p. 318–327  
Le lampade a sospensione cluster devono essere installate su rosone ▶ p. 318–327



# Random

Designed by Chia-Ying Lee

Year 2017

A lightweight, blown glass suspension light, *Random* is made up of three round diffusers of different sizes which form one simple, eye-catching whole. Each diffuser has an LED light source which emits warm white light. When grouped together on a cluster, *Random* light fixtures form a poetic composition like soap bubbles, enhanced by the glossy coloured finishes which add a touch of character and originality.

Leggerissima lampada a sospensione in vetro soffiato, *Random* è composta da tre diffusori sferici di dimensioni diverse che formano un'entità semplice e vivace. Ogni diffusore è dotato di una sorgente luminosa a LED che fornisce una calda luce bianca. Raggruppate su cluster le lampade *Random* danno vita a composizioni poetiche come giochi di bolle di sapone, che le finiture lucide sfumate arricchiscono di carattere e originalità.



Go to the technical info 

Click to discover more 

Random  
COD. 164

CATEGORY LAMP

Cluster suspension

Sospensione cluster

TYPE OF LIGHT

Diffused light

Luce diffusa

































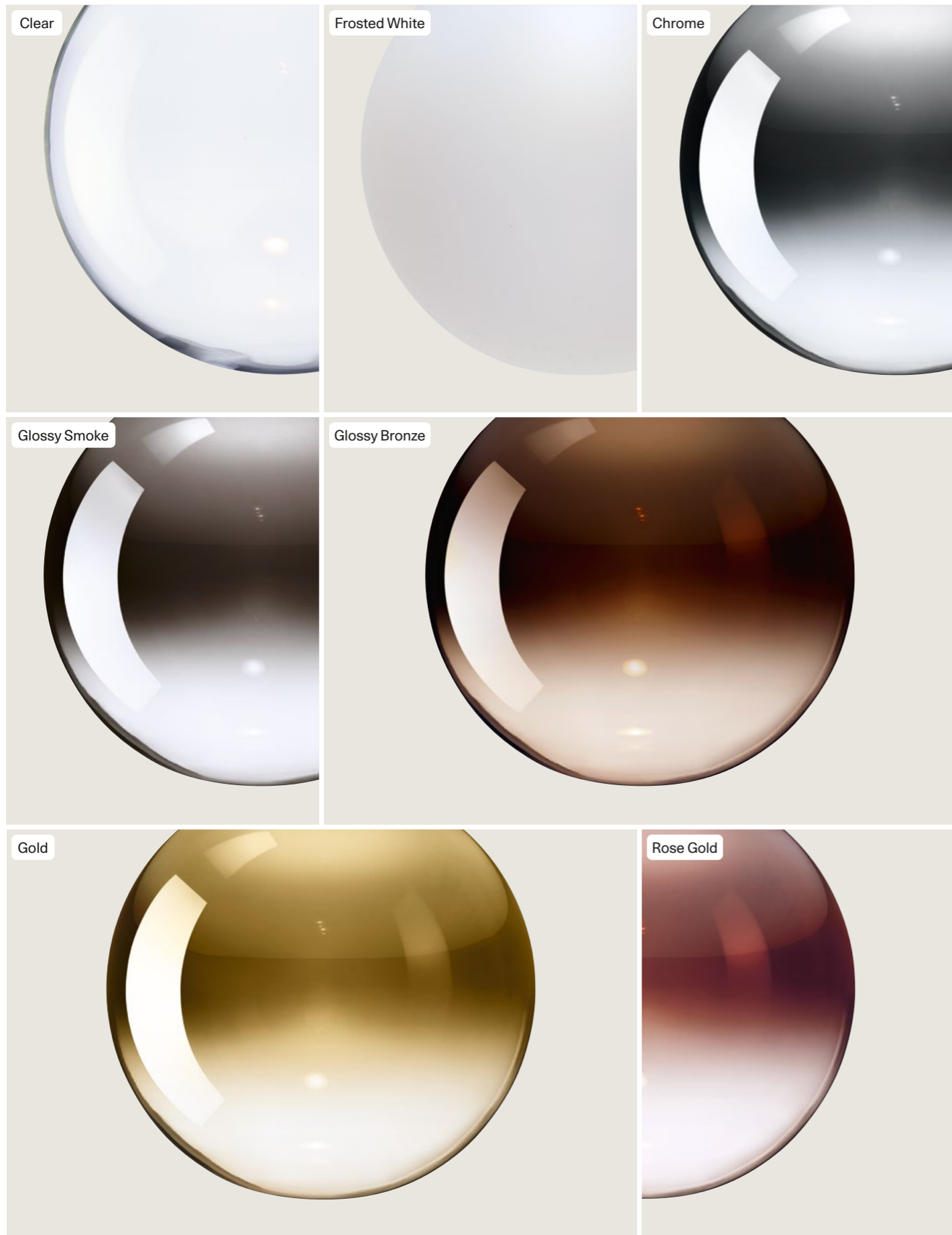



Suspension très légère en verre soufflé, *Random* est composée de trois diffuseurs sphériques de différentes tailles formant une entité simple et vivante. Chaque diffuseur est équipé d'une source lumineuse LED qui fournit une lumière blanche chaude. Regroupées en cluster, les lampes *Random* donnent vie à des compositions poétiques telles que des jeux de bulles de savon, dont les finitions douces et ombragées enrichissent le caractère et l'originalité. ●FR

*Random* ist eine ultraleichte Hängeleuchte aus geblasenem Glas und besteht aus drei kugelförmigen Diffusoren in unterschiedlicher Größe, die eine einfache und lebhafte Einheit bilden. Jeder Diffusor verfügt über eine LED-Lichtquelle, die warmweißes Licht abstrahlt. In Clustern angeordnet, lassen die Leuchten *Random* poetische Kombinationen entstehen, die einem Spiel aus Seifenblasen ähneln und denen die glänzenden, nuancierten Ausführungen Charakter und Originalität verleihen. ●DE

Lámpara muy ligera colgante de vidrio soplado, *Random* está compuesta de tres difusores esféricos de diferentes dimensiones que forman una entidad simple y dinámica. Cada difusor está equipado con una fuente luminosa de LED que proporciona una luz blanca cálida. Reagrupadas en grupos de lámparas colgantes *Random* dan vida a composiciones poéticas como juegos de pompas de jabón, que los acabados brillantes matizados enriquecen con carácter y originalidad. ●ES

*Random* – это легкий подвесной светильник из выдувного стекла, состоящий из трех сферических диффузоров разных размеров, которые образуют простую и живую композицию. Каждый диффузор оснащен светодиодным источником теплого белого света. Объединенные в кластеры лампы *Random* дают жизнь восхитительным композициям, таким как игра мыльных пузырей, а глянцевая отделка придает им своеобразный характер и оригинальность. ●RU

*Random* 是一款非常轻盈的吹制玻璃吊灯，由三个不同尺寸的球形灯罩组成，形成简单活泼的整体。每一个灯罩都配有一个LED光源，提供白色的温暖灯光。集中在组合吊上，*Random*灯可形成诗意的组合，如同肥皂泡的嬉戏，光亮的色泽丰富了个性与原创性。●ZH

CATEGORY CLUSTER SUSPENSION LAMP

Random

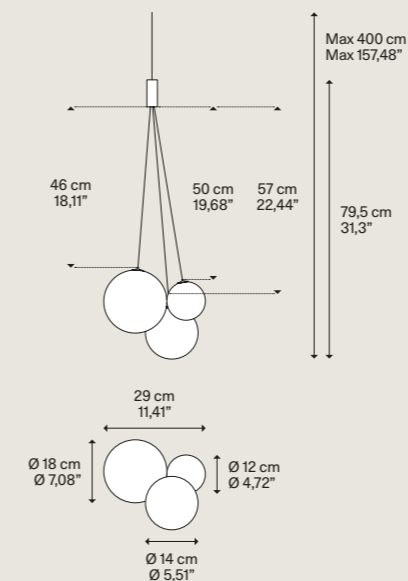

DESIGN Chia-Ying Lee, 2017

Metal structure  
Montatura in metallo



Light source  
Sorgente luminosa

LED  
2700 K  
3x 1 W  
450 lm  
350 mA  
CRI 90  
MacAdam 3-Step  
LED and driver included  
LED e driver inclusi

Blown glass diffuser  
Diffusore in vetro soffiato

	Code Codice <sup>A</sup>	Code Codice <sup>B</sup>
Clear Trasparente	16410 0027	16410 0030
Frosted White Bianco Satinato	16410 1327	16410 1330
Chrome Cromo	16410 4027	16410 4030
Glossy Smoke Fumo Lucido	16410 4327	16410 4330
Glossy Bronze Bronzo Lucido	16410 4627	16410 4630
Gold Oro	16410 5027	16410 5030
Rose Gold Oro Rosa	16410 5527	16410 5530

Light source  
Sorgente luminosa

LED  
3000 K  
3x 1 W  
480 lm  
350 mA  
CRI 90  
MacAdam 3-Step  
LED and driver included  
LED e driver inclusi

Net weight Peso netto	0,88 kg 1,94 lbs	Pack Colli	2	Energy class Classe energetica	D
--------------------------	---------------------	---------------	---	-----------------------------------	---

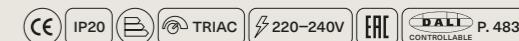

Cluster suspension lamps must be installed on a canopy ► P. 318-327  
Le lampade a sospensione cluster devono essere installate su rosone ► P. 318-327

Random ▾ Cluster suspension lamp

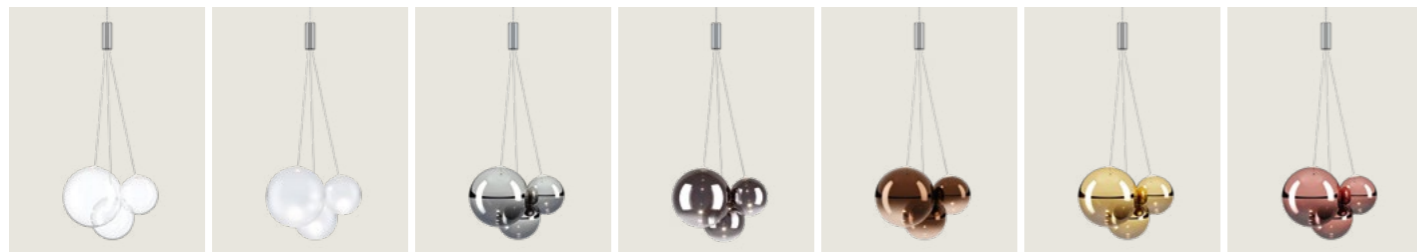



# Volum

Designed by Snøhetta

Year 2022, 2023, 2024

*Volum* celebrates the elegance of simplicity with a series of lamps that, in their similar yet intimately different shapes, complement each other in poetic compositions that narrate an all-round illumination, tailored for various functions and uses. Behind its apparent simplicity, the collection designed in collaboration with architectural firm Snøhetta conceals a complex technical achievement, paying homage to the ancient glassblowing technique that gives life to naturally imperfect shapes. The blown glass spheres of the diffuser, available in diameters of 14, 22, 29, and 42 cm, feature a glossy white finish that evenly radiates light. The *Volum* family includes various models – cluster suspension, ceiling, wall, table, and floor lamps – that enhance any space and situation, whether used individually or in compositions to create original lighting solutions.

*Volum* celebra l'eleganza del minimalismo con una serie di lampade che, nelle loro forme simili ma intimamente diverse, si completano in poetiche composizioni che raccontano un'illuminazione a 360°, declinata in diverse funzioni e utilizzi. Dietro la sua apparente semplicità, la collezione disegnata con lo studio Snøhetta cela una complessa realizzazione e un omaggio all'antica tecnica della soffiatura del vetro che dà vita a forme naturalmente imperfette. Le sfere in vetro soffiato del diffusore, disponibili nelle misure 14, 22, 29 e 42 cm di diametro, sono caratterizzate da una finitura bianca lucida che irradia la luce in modo uniforme. La famiglia *Volum* include varie funzioni – sospensione cluster, sospensione, soffitto, parete, tavolo e terra – in grado di aggiungere valore a qualsiasi spazio e situazione, da sole o in composizione per creare originali soluzioni luminose.

[Go to the technical info](#) [Click to discover more](#)

Volum COD. 187	CATEGORY LAMP	TYPE OF LIGHT
	Cluster suspension Suspension Wall Ceiling Table Floor	Sospensione cluster Sospensione Parete Soffitto Tavolo Terra

NEW



Volum 29 cluster suspension lamp, Volum 14, 22 wall lamp and Volum 14, 22, 29, 42 table lamp, FINISH Glossy White.









148 Volum, the methacrylate lid lets light through the same way as the glass, FINISH Glossy White.



Volum 14, 22 and 29, 2x composition of 3 lights on a round canopy and single lights on recessed micro canopies.





Volum 14 and 22, composition of 12 lights on *radial canopy*, FINISH Glossy White.













Volum floor lamp, FINISH Glossy White.

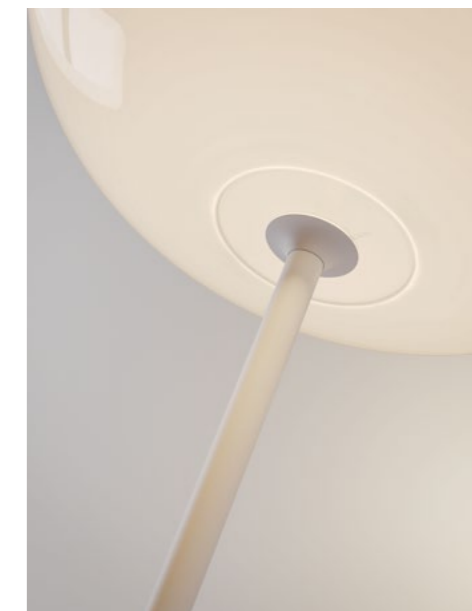

Volum floor lamp, blown glass diffuser, FINISH Glossy White.









160 Volum short & long 29 and Volum short & long 42, FINISH Glossy White.



Volum 14, 22, 29 and 42 table lamp, FINISH Glossy White.







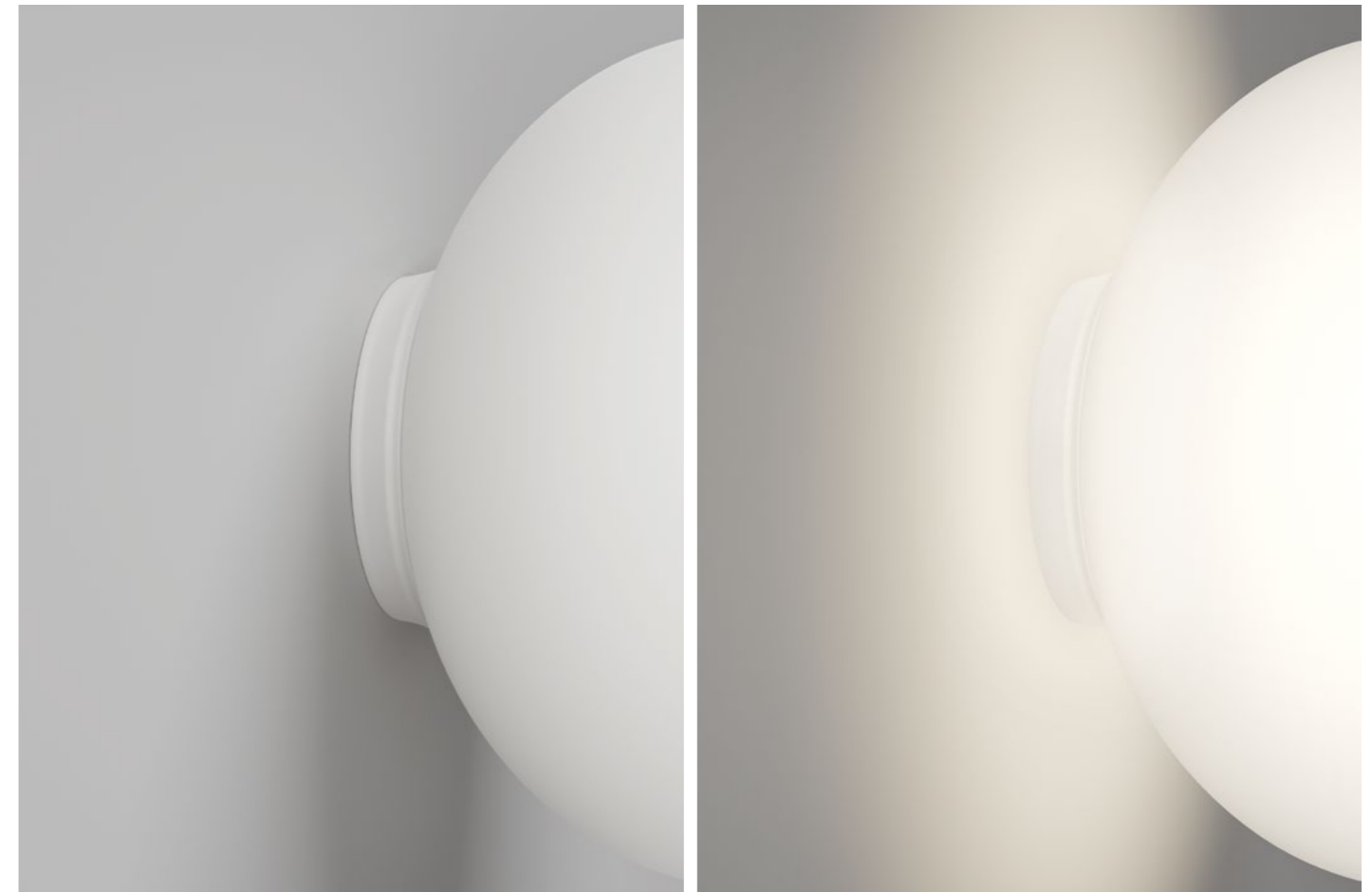

Volum wall lamp, translucent silicone structure.





*Volum* célèbre l'élégance de la simplicité à travers une série de lampes qui, dans leurs formes similaires mais intimement différentes, se complètent dans des compositions poétiques qui transmettent un éclairage complet, décliné en différentes fonctions et utilisations. Mais derrière sa simplicité apparente, la collection conçue avec le studio Snøhetta dissimule une réalisation complexe et un hommage à l'ancienne technique du soufflage du verre qui donne vie à des formes naturellement imparfaites. Les sphères en verre soufflé du diffuseur, disponibles dans les diamètres 14, 22, 29 et 42 cm, se caractérisent par une finition blanc brillant qui diffuse uniformément la lumière. La famille *Volum* prévoit différentes fonctions – suspension en cluster, suspension, plafonnier, applique, table et sol – en mesure de valoriser tous les types d'espace et situation, seules ou en composition pour créer des solutions d'éclairage originales. ●FR

*Volum* celebra la elegancia de la simplicidad con una serie de lámparas que, en sus formas parecidas e intimamente distintas a la vez, se completan en composiciones poéticas que narran una iluminación a 360° con diferentes funciones y usos. Detrás de su aparente simplicidad, la colección diseñada con el estudio Snøhetta esconde una compleja realización y un homenaje a la antigua técnica del soplado del vidrio que da vida a formas naturalmente imperfectas. Las esferas de vidrio soplado del difusor, disponibles en las medidas 14, 22, 29 y 42 cm de diámetro, se caracterizan por un acabado blanco brillante que proyecta la luz de manera uniforme. La familia *Volum* incluye varias funciones – suspensión cluster, suspensión, techo, pared, sobremesa y pie – capaces de aportar valor añadido a cualquier espacio y situación, por sí solas o en composiciones para crear originales soluciones de iluminación. ●ES

*Volum* прославляет элегантность простоты серий ламп с похожими, но совершенно разными формами, дополняющих друг друга в поэтических композициях, с освещением на 360°, с различными функциями и способами применения. За кажущейся простотой коллекция, разработанная совместно со студией Snøhetta, скрывает сложную техническую реализацию, отдающую дань уважения древней технике выдувания стекла, которая создает естественно несовершенные формы. Сферы диффузора из дутого стекла, с размерами 14, 22, 29 и 42 см в диаметре, характеризуются глянцевой белой отделкой, равномерно излучающей свет. Семейство *Volum* включает в себя различные функциональные формы, кластерную подвесную, подвесную, потолочную, настенную, настольную и напольную, способные украсить любое пространство и ситуацию, по отдельности или в композиции, для создания оригинальных световых решений. ●RU

*Volum*以一系列灯具礼赞简约的优雅。这些灯具形状相似却又截然不同,在充满诗意的组合中相互补充,传达能够用于不同功能和用途的360°照明。然而在其看似简单的背后,这个与Snøhetta建筑工作室联袂设计的系列却隐藏着一种复杂的技术制作工艺并礼赞古老的吹制玻璃技术,这种技术为那些以自然方式不甚完美的形状赋予生命。灯罩的吹制玻璃球体提供直径14、22、29和42厘米这几种可选尺寸,可均匀辐射光线的亮白色饰面是其特征所在。*Volum*系列包含各种功能 – 组合悬吊灯、悬吊灯、吸顶灯、壁灯、台灯和落地灯 – 它们能够为任何空间和场合增值,单独或组合创建原创照明解决方案。●ZH

Volum 14, 22, 29 ↘ Cluster suspension lamp

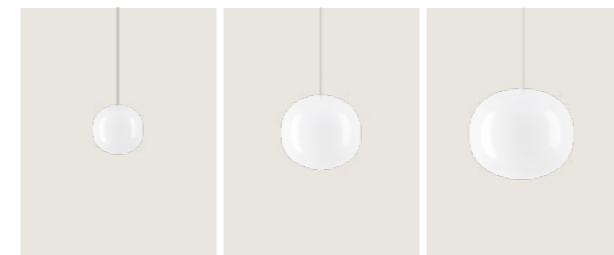

42 ↘ Suspension lamp



Volum short & long 29 ↘ Floor lamp

NEW LAMP



Volum 14, 22, 29, 42 ↘ Table lamp

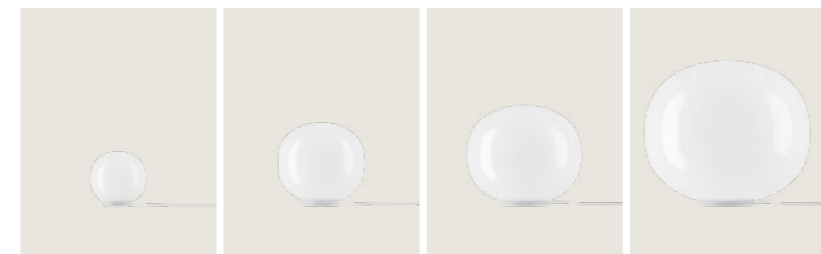

Volum short & long 42 ↘ Floor lamp

NEW LAMP



Volum 14, 22, 29, 42 ↘ Ceiling lamp, Wall lamp

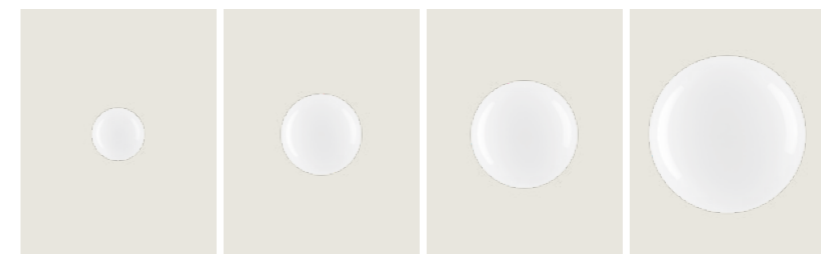











CATEGORY FLOOR LAMP NEW LAMP

DESIGN Snøhetta, 2024

### Volum short 29

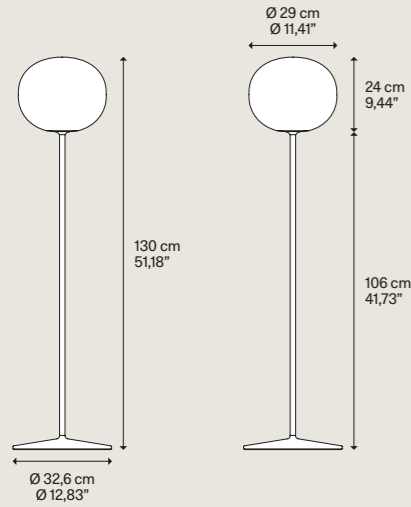

Net weight 8,33 kg / 18,36 lbs  
Pack Colli 2  
Energy class Classe energetica D

Metal structure  
Montatura in metallo

White  
Bianco

Blown glass diffuser  
Diffusore in vetro soffiato

Glossy White  
Bianco Lucido

Code  
Codice

18771 1200

Light source  
Sorgente luminosa

E27 LED T28 1 x 10 W (max 25 W)  
Ø max 6 cm / Ø max 2,36"  
W/L max 12,5 cm / W/L max 4,92"

Bulb not included  
Lampadina non inclusa  
Dimmer switch on the cord  
Interuttore con dimmer sul cavo

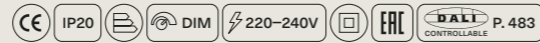

NEW LAMP

### Volum long 29

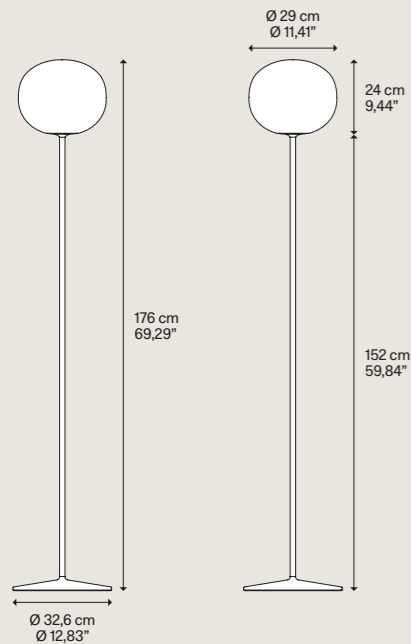

Net weight 8,67 kg / 19,11 lbs  
Pack Colli 2  
Energy class Classe energetica D

Metal structure  
Montatura in metallo

White  
Bianco

Blown glass diffuser  
Diffusore in vetro soffiato

Glossy White  
Bianco Lucido

Code  
Codice

18773 1200

Light source  
Sorgente luminosa

E27 LED T28 1 x 10 W (max 25 W)  
Ø max 6 cm / Ø max 2,36"  
W/L max 12,5 cm / W/L max 4,92"

Bulb not included  
Lampadina non inclusa  
Dimmer switch on the cord  
Interuttore con dimmer sul cavo

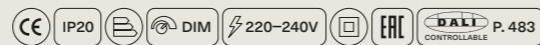

CATEGORY FLOOR LAMP NEW LAMP

DESIGN Snøhetta, 2024

### Volum short 42

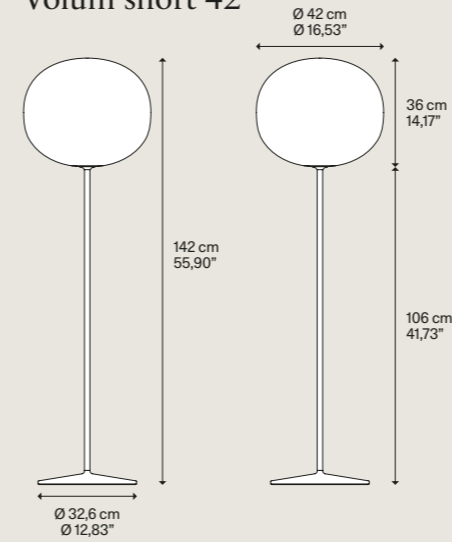

Net weight 9,53 kg / 21,01 lbs  
Pack Colli 2  
Energy class Classe energetica D

Metal structure  
Montatura in metallo

White  
Bianco

Blown glass diffuser  
Diffusore in vetro soffiato

Glossy White  
Bianco Lucido

Code  
Codice

18772 1200

Light source  
Sorgente luminosa

E27 LED T35 1 x 21 W (max 25 W)  
Ø max 9,8 cm / Ø max 3,85"

Bulb not included  
Lampadina non inclusa  
Dimmer switch on the cord  
Interuttore con dimmer sul cavo

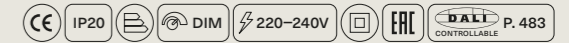

NEW LAMP

### Volum long 42

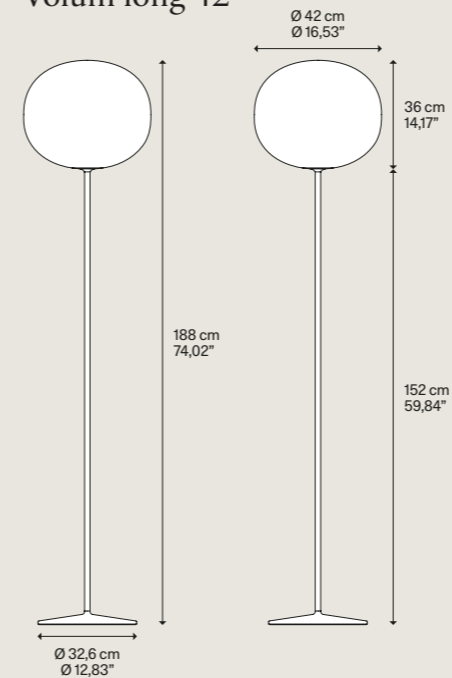

Net weight 9,87 kg / 21,75 lbs  
Pack Colli 2  
Energy class Classe energetica D

Metal structure  
Montatura in metallo

White  
Bianco

Blown glass diffuser  
Diffusore in vetro soffiato

Glossy White  
Bianco Lucido

Code  
Codice

18774 1200

Light source  
Sorgente luminosa

E27 LED T35 1 x 21 W (max 25 W)  
Ø max 9,8 cm / Ø max 3,85"

Bulb not included  
Lampadina non inclusa  
Dimmer switch on the cord  
Interuttore con dimmer sul cavo

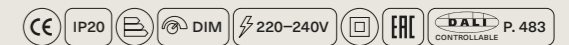

Light source  
Dimensioe lampadina

E14 LED T18 5 W	2700 K 500 lm	CRI 90 MacAdam 3-Step
E27 LED T28 10 W	2700 K 1000 lm	CRI 90 MacAdam 3-Step
E27 LED T35 13 W	2700 K 1500 lm	CRI 90 MacAdam 3-Step
E27 LED T35 21 W	2700 K 2010 lm	CRI 90 MacAdam 3-Step

Bulb dimension  
Dimensione lampadina

Ø 1,8 cm / Ø 0,70"	W/L 6,1 cm / W/L 2,40"
Ø 2,8 cm / Ø 1,10"	W/L 11,3 cm / W/L 4,44"
Ø 3,5 cm / Ø 1,37"	W/L 15 cm / W/L 5,90"
Ø 3,5 cm / Ø 1,37"	W/L 15 cm / W/L 5,90"

Lamp  
Lampada

Volum 14 P. 168, 169, 170, 171
Volum 22, Volum short and long 29 P. 168, 169, 170, 171, 172
Volum 29 P. 168, 169, 170, 171
Volum 42, Volum short and long 42 P. 168, 169, 170, 171, 173

Pack  
Colli

1
1
1
1

Code  
Codice

LAM-0017
LAM-0014
LAM-0015
LAM-0016

Dimmable bulbs / Lampadine dimmerabili



# Nostalgia

Designed by Dima Loginoff

Year 2015

*Nostalgia* with its retro flair, *Nostalgia* elegantly tells of ancient glass blowing practices in three sinuous forms that can be combined at will. The perfection of the glass, the innovative LED technology and five elegant finishes make *Nostalgia* an extremely modern and versatile lamp that lends itself to the creation of captivating atmospheres, whether on or off. Available with a black frame and cable or chrome and white cable for all finishes, these combinations offer wide-ranging possibilities to personalize any space: on its own to illuminate a table or to add a sophisticated touch to a bedroom, in linear groups above a counter or peninsula, or in cluster compositions to emphasise larger spaces with refined scenic effects.

Con il suo sapore retrò, *Nostalgia* racconta con eleganza antiche storie di vetro soffiato in tre forme sinuose che possono essere combinate a piacere. La perfezione del vetro, l'innovativa tecnologia LED e le cinque raffinate finiture fanno di *Nostalgia* una lampada estremamente contemporanea e versatile che permette di creare atmosfere affascinanti sia da accesa che da spenta. Disponibile nelle versioni con montatura e cavo nero oppure cromo con cavo bianco per tutte le finiture, tali combinazioni offrono ampie possibilità di personalizzazione di ogni spazio: da sola per illuminare un tavolo o per conferire un tocco sofisticato alla stanza da letto, in gruppi lineari sopra un bancone o una penisola, oppure in composizioni su cluster per dare risalto a spazi più ampi con raffinati effetti scenografici.



Go to the technical info



Click to discover more



Nostalgia  
COD. 154

CATEGORY LAMP

Cluster suspension

Sospensione cluster

TYPE OF LIGHT

Symmetrical diffused light

Luce simmetrica diffusa











178 Nostalgia medium and small, FINISHES Rose Gold and Clear, black cable and black structure version.



Nostalgia small, FINISH Glossy Smoke, black cable and black structure version.











Avec son côté rétro, *Nostalgia* raconte avec élégance les pratiques anciennes du soufflage du verre sous trois formes sinueuses à combiner à volonté. La perfection du verre, la technologie LED innovante et les cinq finitions élégantes font de *Nostalgia* une lampe extrêmement moderne et polyvalente qui se prête à la création d'atmosphères captivantes, qu'elle soit allumée ou éteinte. Disponible dans les versions avec monture et câble noir ou chrome avec câble blanc pour toutes les finitions, ces combinaisons offrent de grandes possibilités de personnalisation de tous les espaces : seule, pour éclairer une table ou ajouter une touche sophistiquée à une chambre, en groupes linéaires au-dessus d'un comptoir ou d'un îlot, ou dans des compositions en cluster pour mettre en exergue des espaces plus grands avec des effets scéniques raffinés. ●FR

Mit ihrem Retro-Flair, erzählt *Nostalgia* auf elegante Weise von alten Glasbläsertechniken in drei gewundenen Formen, die beliebig kombiniert werden können. Die Perfektion des Glases, die innovative LED-Technologie und die fünf eleganten Ausführungen machen *Nostalgia* zu einer äußerst modernen und vielseitigen Leuchte, mit der sich sowohl im eingeschalteten als auch im ausgeschalteten Zustand faszinierende Stimmungen erzeugen lassen. Erhältlich in den Versionen mit schwarzem Gestell und Kabel oder verchromt mit weißes Kabel für alle Ausführungen, bieten diese Kombinationen Möglichkeiten zur individuellen Gestaltung von jedem Raum: einzeln zur Beleuchtung eines Tisches oder als raffinierter Akzent in einem Schlafzimmer, in linearen Gruppen über einer Theke oder Halbinsel oder in Cluster-Kompositionen, um größere Räume mit raffinierten szenischen Effekten zu betonen. ●DE

Con su estilo retro, *Nostalgia* narra con elegancia viejas historias de vidrio soplado con tres formas sinuosas que pueden combinarse según se desee. La perfección del vidrio, la innovadora tecnología LED y sus cinco sofisticados acabados hacen de *Nostalgia* una lámpara sumamente moderna y versátil que permite crear atmósferas cautivadoras, tanto encendida como apagada. Disponible en las versiones con estructura y cable negro o bien cromada con cable blanco para todos los acabados, estas combinaciones ofrecen un gran abanico de posibilidades de personalizar cualquier espacio: por sí sola para iluminar una mesa o aportar un toque de sofisticación a un dormitorio, en grupos lineales encima de una barra o una isleta, o en grupos de lámparas colgantes para acentuar espacios más amplios con sofisticados efectos escénicos. ●ES

*Nostalgia* с ее ретро-стилем элегантно повествует о древнем искусстве выдувания стекла, отраженном в трех извилистых формах, которые можно сочетать по желанию. Совершенство стекла, инновационная светодиодная технология и пять элегантных вариантов отделки делают *Nostalgia* современным и универсальным светильником, создающим волшебную атмосферу как во включенном, так и в выключенном состоянии. Она доступна в версии с черной рамой и кабелем или в хромовой версии с белым кабелем для всех видов отделки; эти сочетания предлагают возможности для индивидуального оформления любых помещений: она может использоваться для освещения стола или вносить изысканный штрих в спальню, применяться в линейных группах над кухонной стойкой или полуостровом, или в кластерных композициях, подчеркивающих большие пространства изысканными сценическими эффектами. ●RU

以其怀旧复古的格调, *Nostalgia*用三种可随意组合的蜿蜒形状优雅地讲述了古老玻璃吹制的实践方式。玻璃的完美、LED技术的创新和五种优雅饰面使*Nostalgia*成为一款极为现代且功能多用的灯品, 无论点亮时还是关闭时都有助于迷人氛围的营造。提供黑色框架搭配黑色线缆的版本或是镀铬框架搭配白色线缆的版本, 这些组合适用于所有饰面, 这些组合扩展了将任何空间做到个性化的可能性: 它可单独照亮桌子或为卧室凭添一份精致润色, 通过位于吧台或半岛上方的流线型组合或通过底盘组合彰显具有精致场景效果的更大空间。●ZH

White fabric cable and chrome structure

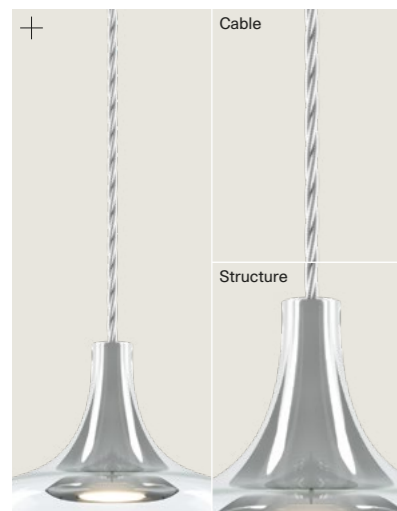

Black fabric cable and black structure



Nostalgia small › Cluster suspension lamp



Nostalgia medium › Cluster suspension lamp



Nostalgia large › Cluster suspension lamp





## CATEGORY CLUSTER SUSPENSION LAMP

DESIGN Dima Loginoff, 2015

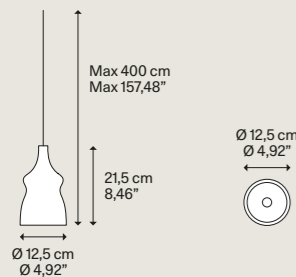

## Nostalgia small

Light source  
Sorgente luminosa

LED  
2700 K  
7 W  
1280 lm  
350 mA  
CRI 90  
MacAdam 3-Step

LED and driver included  
LED e driver inclusi

Metal structure  
Montatura in metallo

-  Chrome  
Cromo
-  White fabric cable  
Cavo bianco in tessuto

-  Matte Black - 9005  
Nero Opaco - 9005

-  Black fabric cable  
Cavo nero in tessuto

Blown glass diffuser  
Diffusore in vetro soffiato

 Clear Trasparente	15412 0027
 Glossy Smoke Fumo Lucido	15412 4327
 Glossy Bronze Bronzo Lucido	15412 4627
 Gold Oro	15412 5027
 Rose Gold Oro Rosa	15412 5527
 Clear Trasparente	15415 0027
 Glossy Smoke Fumo Lucido	15415 4327
 Glossy Bronze Bronzo Lucido	15415 4627
 Gold Oro	15415 5027
 Rose Gold Oro Rosa	15415 5527

Net weight Peso netto	0,66 kg 1,46 lbs	Pack Colli	2	Energy class Classe energetica	C
--------------------------	---------------------	---------------	---	-----------------------------------	---

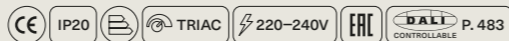

## CATEGORY CLUSTER SUSPENSION LAMP

DESIGN Dima Loginoff, 2015

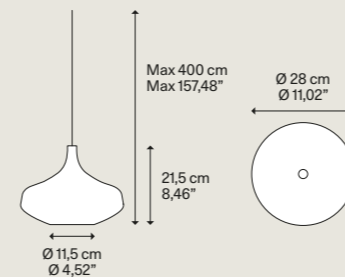

## Nostalgia large

Light source  
Sorgente luminosa

LED  
2700 K  
7 W  
1280 lm  
350 mA  
CRI 90  
MacAdam 3-Step

LED and driver included  
LED e driver inclusi

Metal structure  
Montatura in metallo

-  Chrome  
Cromo
-  White fabric cable  
Cavo bianco in tessuto

-  Matte Black - 9005  
Nero Opaco - 9005

-  Black fabric cable  
Cavo nero in tessuto

Blown glass diffuser  
Diffusore in vetro soffiato

 Clear Trasparente	15414 0027
 Glossy Smoke Fumo Lucido	15414 4327
 Glossy Bronze Bronzo Lucido	15414 4627
 Gold Oro	15414 5027
 Rose Gold Oro Rosa	15414 5527
 Clear Trasparente	15417 0027
 Glossy Smoke Fumo Lucido	15417 4327
 Glossy Bronze Bronzo Lucido	15417 4627
 Gold Oro	15417 5027
 Rose Gold Oro Rosa	15417 5527

Net weight Peso netto	1,02 kg 2,25 lbs	Pack Colli	2	Energy class Classe energetica	C
--------------------------	---------------------	---------------	---	-----------------------------------	---

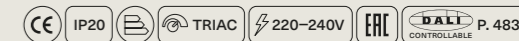

Cluster suspension lamps must be installed on a canopy ► P. 318-327  
Le lampade a sospensione cluster devono essere installate su rosone ► P. 318-327

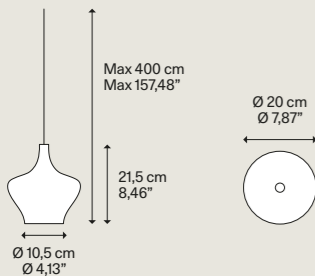

## Nostalgia medium

Light source  
Sorgente luminosa

LED  
2700 K  
7 W  
1280 lm  
350 mA  
CRI 90  
MacAdam 3-Step

LED and driver included  
LED e driver inclusi

Metal structure  
Montatura in metallo

-  Chrome  
Cromo
-  White fabric cable  
Cavo bianco in tessuto

-  Matte Black - 9005  
Nero Opaco - 9005

-  Black fabric cable  
Cavo nero in tessuto

Blown glass diffuser  
Diffusore in vetro soffiato

 Clear Trasparente	15413 0027
 Glossy Smoke Fumo Lucido	15413 4327
 Glossy Bronze Bronzo Lucido	15413 4627
 Gold Oro	15413 5027
 Rose Gold Oro Rosa	15413 5527
 Clear Trasparente	15416 0027
 Glossy Smoke Fumo Lucido	15416 4327
 Glossy Bronze Bronzo Lucido	15416 4627
 Gold Oro	15416 5027
 Rose Gold Oro Rosa	15416 5527

Net weight Peso netto	0,75 kg 1,65 lbs	Pack Colli	2	Energy class Classe energetica	C
--------------------------	---------------------	---------------	---	-----------------------------------	---

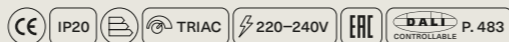

Cluster suspension lamps must be installed on a canopy ► P. 318-327  
Le lampade a sospensione cluster devono essere installate su rosone ► P. 318-327



# Jefferson

Designed by Luca Nichetto

Year 2019

The *Jefferson* suspension lamp designed by Luca Nichetto is reminiscent of music and iconic images in psychedelic works of art from the 1960s. The vortex motif decorating the diffuser is embellished by the timeless classicism of Bohemian crystal, which diffuses evocative atmospheres of light. Dynamic in both its sizes and multiple compositions, *Jefferson's* elegance keeps up with the excellent performance of LED interior lighting.

La lampada a sospensione *Jefferson* disegnata da Luca Nichetto rimanda alla musica e alle immagini iconiche in opere d'arte psichedeliche degli anni Sessanta. Il motivo a vortice che decora il diffusore è impreziosito dalla classicità senza tempo del cristallo di Boemia, che diffonde suggestive atmosfere di luce. Dinamica in entrambe le dimensioni e in composizioni multiple, l'eleganza di *Jefferson* non rinuncia alle eccellenti prestazioni della luce interna a LED.



Go to the technical info [+](#) Click to discover more [↓](#)

Jefferson  
COD. 168

CATEGORY LAMP		TYPE OF LIGHT	
Cluster suspension	Sospensione cluster	Diffused light	Luce diffusa
			





Jefferson mini and small, special composition of 68 lights, FINISH Clear + Gold.









Jefferson mini, composition of 30 lights on a *round canopy*, FINISH Clear + Black Chrome.



La suspension *Jefferson* dessinée par Luca Nichetto fait référence à la musique et aux images emblématiques des œuvres d'art psychédélics des années Soixante. Le motif vortex qui orne le diffuseur est rehaussé par le classicisme intemporel du cristal de Bohême, qui diffuse des atmosphères de lumière suggestives. Dynamique dans les deux tailles et dans de multiples compositions, l'élégance de *Jefferson* ne renonce jamais aux excellentes performances de l'éclairage intérieur LED. ●FR

Die von Luca Nichetto entworfene Hängeleuchte „*Jefferson*“ erinnert an die Musik und die ikonischen Darstellungen in psychedelischen Kunstwerken der sechziger Jahre. Die Wirbel-Optik des Diffusors wird aufgewertet durch den klassisch-zeitlosen Stil des böhmischen Kristalls, das suggestive Lichtstimmungen erzeugt. Dynamisch in beiden Größen und in vielfältigen Kompositionen, verzichtet die Eleganz von *Jefferson* nicht auf die hervorragende Leistung der LED-Innenbeleuchtung. ●DE

La lámpara de suspensión *Jefferson* diseñada por Luca Nichetto evoca la música y las imágenes icónicas en obras de arte psicodélicas de los años 60. El motivo en espiral que decora el difusor lo embellece el clasicismo atemporal del cristal de Bohemia que difunde atmósferas sugestivas de luz. Dinámica en ambos tamaños y en composiciones múltiples, la elegancia de *Jefferson* no renuncia a las excelentes prestaciones de la luz interna de LED. ●ES

Подвесной светильник *Jefferson*, дизайн Лука Никетто, вызывает в памяти музыку и культовые изображения на психоделических произведениях шестидесятых годов. Ценность вихревому украшению диффузора придает вечная классика богемского хрусталя, благодаря которому создается необыкновенная световая атмосфера. Элегантная и динамичная в обоих размерах и множественных комбинациях модель *Jefferson* не отказывается от превосходных характеристик внутреннего светодиодного освещения. ●RU

Luca Nichetto受上世纪六十年代迷幻视觉艺术的音乐和图案的启发设计了吊灯*Jefferson*。灯罩上装饰的漩涡图案因波西米亚水晶的永恒古典主义更显精美珍贵，将迷人的光线散发开来。*Jefferson*吊灯具有两种尺寸和多种组成的动态变化，精美雅致的同时更良好利用了内置LED灯的出色性能。●ZH

#### CATEGORY CLUSTER SUSPENSION LAMP

### Jefferson mini

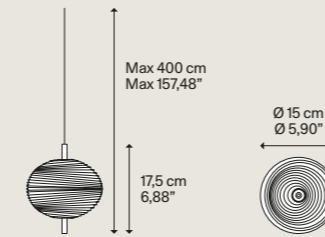

Net weight	1,40 kg	Pack	1	Energy class	D
Peso netto	3,09 lbs	Colli		Classe energetica	

#### DESIGN Luca Nichetto, 2019

##### Metal structure Montatura in metallo

- Black Chrome  
Cromo Nero
- Gold  
Oro

##### Light source Sorgente luminosa

LED  
2700 K  
3 W  
450 lm  
350 mA  
CRI 90  
MacAdam 3-Step

LED and driver included  
LED e driver inclusi

##### Bohemian crystal diffuser Diffusore in cristallo di Boemia

- Clear  
Trasparente

##### Code Codice

16821 4227  
16821 5027



### Jefferson small

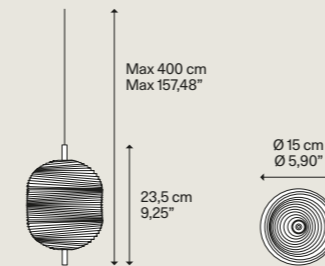

Net weight	2,10 kg	Pack	1	Energy class	D
Peso netto	4,63 lbs	Colli		Classe energetica	

##### Metal structure Montatura in metallo

- Black Chrome  
Cromo Nero
- Gold  
Oro

##### Light source Sorgente luminosa

LED  
2700 K  
3 W  
450 lm  
350 mA  
CRI 90  
MacAdam 3-Step

LED and driver included  
LED e driver inclusi

##### Bohemian crystal diffuser Diffusore in cristallo di Boemia

- Clear  
Trasparente

##### Code Codice

16822 4227  
16822 5027

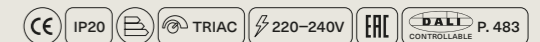

Cluster suspension lamps must be installed on a canopy ► p. 318-327  
Le lampade a sospensione cluster devono essere installate su rosone ► p. 318-327

Jefferson mini › Cluster suspension lamp



Jefferson small › Cluster suspension lamp





# Spider

Designed by Andrea Tosetto



Year 2015, 2022

*Spider* is a round suspension lamp resembling an eye that can look into any part of the room. By adjusting the angle of the diffuser, the light beam emitted by the LED light can be directed towards any specific point. When installed on the different clusters available, it can create numerous lighting patterns, from functional to decorative, which can be dimmed at will. Available also as ceiling light. In *Spider*, the simplicity of the looks underscores the versatility of its performance.

*Spider* è una lampada a sospensione sferica che ricorda un occhio che può guardare in qualsiasi punto della stanza. Regolando l'angolo del diffusore si può infatti dirigere il fascio di luce a LED su un particolare punto di interesse, mentre montata sui diversi cluster disponibili può creare molteplici schemi di luce, dal funzionale al decorativo, dimmerabili a piacere. Disponibile anche nella versione a soffitto. In *Spider*, la semplicità della forma esalta la versatilità delle prestazioni.



Go to the technical info [+](#) [Click to discover more](#) [↓](#)

Spider COD. 160/183	CATEGORY LAMP		TYPE OF LIGHT	
	Cluster suspension Ceiling	Sospensione cluster Soffitto	Symmetrical diffused light Adjustable light	Luce simmetrica diffusa Luce orientabile
	 			









Spider, FINISH Matte White.



Spider, FINISH Matte Champagne.









Spider, FINISH Matte Black.







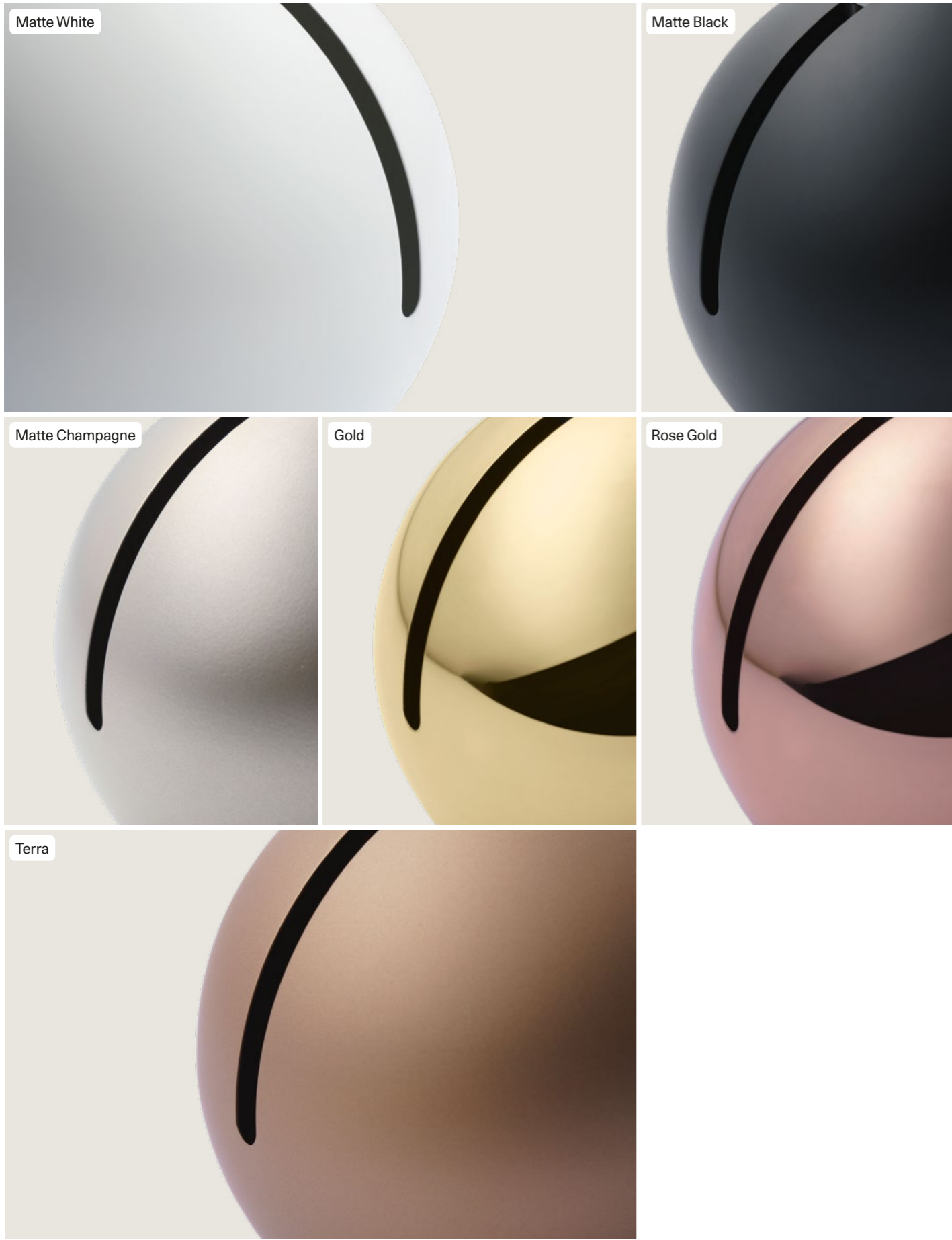

210 Spider, metal diffuser finishes.



Spider, FINISH Matte Champagne.



*Spider* est une suspension sphérique qui fait penser à un œil qui peut regarder n'importe où dans la pièce. En réglant l'angle du diffuseur, vous pouvez en effet diriger le faisceau de lumière LED vers un point d'intérêt particulier, tandis que montée sur les différents clusters disponibles, elle peut créer plusieurs schémas d'éclairage, du fonctionnel au décoratif, variables à souhait. Disponible aussi en version plafonnier. La simplicité de la forme de *Spider* met en valeur la polyvalence des performances. ●FR

*Spider* ist eine kugelförmige Hängeleuchte, die an ein Auge erinnert, das jeden Punkt im Raum erblicken kann. Durch Einstellen des Winkels des Diffusors kann der LED-Lichtstrahl tatsächlich auf eine spezielle Stelle gerichtet werden, während durch die Kombination zu unterschiedlichen verfügbaren Clustern verschiedene Lichtschemata erstellt werden können – von funktionell bis dekorativ und nach Belieben dimmbar. Auch als Deckenversion erhältlich. Bei *Spider* betont die Einfachheit der Form die vielseitigen Leistungen. ●DE

*Spider* es una lámpara de suspensión esférica que recuerda un ojo que puede mirar a cualquier punto de la habitación. De hecho, regulando el ángulo del difusor se puede dirigir el haz de luz de LED a un punto de interés concreto, mientras que montada en los diferentes grupos de lámparas de suspensión disponibles puede crear múltiples patrones de luz, del funcional al decorativo, que pueden regularse como se desee. También está disponible en la versión de techo. En *Spider*, la simplicidad de la forma acentúa la versatilidad de las prestaciones. ●ES

*Spider* – это сферический подвесной светильник, напоминающий глаз, который может смотреть в любую точку помещения. Регулируя угол диффузора, можно направлять пучок светодиодного света на конкретную точку, а при установке в различных кластерах – создавать разнообразные схемы освещения, от функционального до декоративного, с возможностью регулировки яркости. Лампа выпускается также в форме потолочного плафона. Простота формы *Spider* подчеркивает его универсальность. ●RU

*Spider* 是一款球形吊灯，像一只眼睛，可以望向房间里的每一个角落。调节灯罩的角度，可以把LED灯的光束调向特定角度，如安装在不同的组合吊上，可营造多重光幕，可满足从功能性到装饰性的需求，并根据喜好调光。吸顶灯版本如今也可提供。*Spider*的简单造型彰显了其性能的广泛用途。●ZH

Spider » Cluster suspension lamp



Spider » Ceiling lamp

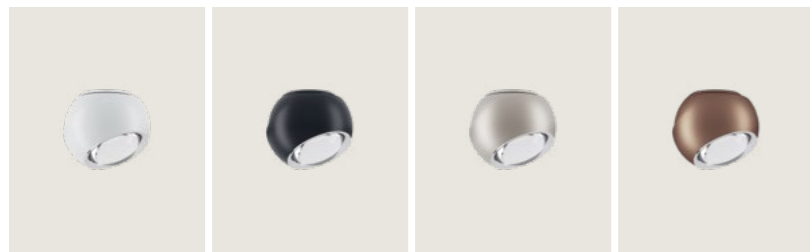

CATEGORY CLUSTER SUSPENSION LAMP

Spider

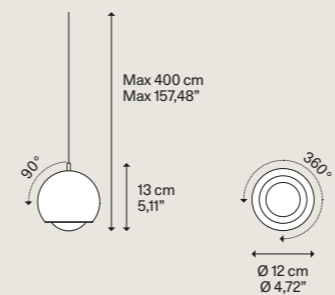

**Light source**  
Sorgente luminosa **A**

LED	
2700	K
11	W
1280	lm
350	mA
CRI 90	
MacAdam 3-Step	

LED and driver included  
LED e driver inclusi

**Light source**  
Sorgente luminosa **B**

LED	
3000	K
11	W
1300	lm
350	mA
CRI 90	
MacAdam 3-Step	

LED and driver included  
LED e driver inclusi

DESIGN Andrea Tosetto, 2015

Metal structure  
Montatura in metallo

Chrome  
Cromo

Metal diffuser  
Diffusore in metallo

Matte White-9010 Bianco Opaco-9010	16010 1027	16010 1030
Matte Black-9005 Nero Opaco-9005	16010 2027	16010 2030
Extra Matte Champagne Champagne Extra Opaco	16010 4527	16010 4530
Gold Oro	16010 5027	16010 5030
Rose Gold Oro Rosa	16010 5527	16010 5530
Terra Terra	16010 6727	16010 6730

Adjustable light  
Luce orientabile

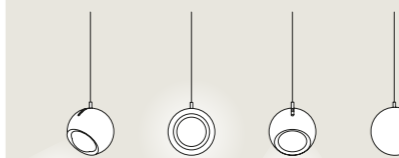

Net weight	0,80 kg	Pack	2	Energy class	C
Peso netto	1,76 lbs	Colli		Classe energetica	

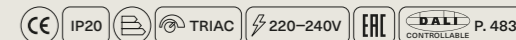

Cluster suspension lamps must be installed on a canopy ► P. 318-327  
Le lampade a sospensione cluster devono essere installate su rosone ► P. 318-327

CATEGORY CEILING LAMP

Spider

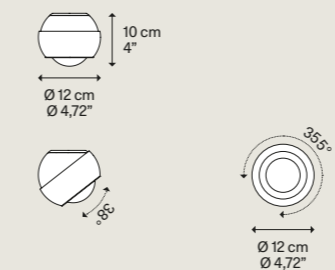

**Light source**  
Sorgente luminosa **A**

AC LED	
2700	K
10	W
920	lm
220-240	V
CRI 90	
MacAdam 3-Step	

LED included  
LED incluso

**Light source**  
Sorgente luminosa **B**

AC LED	
3000	K
10	W
980	lm
220-240	V
CRI 90	
MacAdam 3-Step	

LED included  
LED incluso

DESIGN Andrea Tosetto, 2022

Metal structure  
Montatura in metallo

Chrome  
Cromo

Metal diffuser  
Diffusore in metallo

Matte White-9010 Bianco Opaco-9010	18340 1027	18340 1030
Matte Black-9005 Nero Opaco-9005	18340 2027	18340 2030
Extra Matte Champagne Champagne Extra Opaco	18340 4527	18340 4530
Terra Terra	18340 6727	18340 6730

Adjustable light  
Luce orientabile



Net weight	0,86 kg	Pack	2	Energy class	F
Peso netto	1,89 lbs	Colli		Classe energetica	

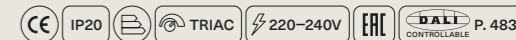

► LED sources with direct power supply to the AC line voltage – driver not required. Dimmable with phase cut dimmer.

► LED con alimentazione diretta a tensione di rete – non necessita di driver. Dimmerabile con varialuce a taglio di fase.



# Rain

Designed by Andrea Toso

Year 2015

*Rain* falls from the ceiling like a drop of spring rain, with a linear movement that accentuates the curvaceous conical forms of its body. A metal suspension lamp with an LED light source – simple and effective, elegant and extremely bright, to be used either independently or as a scenic composition.

*Rain* scende dal soffitto come una goccia di pioggia primaverile, con un movimento lineare che accentua le sinuose forme coniche del suo corpo. Una sospensione in metallo con sorgente luminosa a LED – semplice ed efficace, elegante ed estremamente luminosa, da usare da sola o in composizioni scenografiche.



Go to the technical info [+](#)

Click to discover more [↓](#)

Rain  
COD. 156

CATEGORY LAMP

Cluster suspension

Sospensione cluster

TYPE OF LIGHT

Symmetrical diffused light

Luce simmetrica diffusa



















222 Rain, composition of 3 lights on a *short track*, FINISH Chrome + Coppery Bronze.



Rain, FINISH Chrome + Matte Black.



*Rain*, une goutte de pluie printanière descend du plafond, avec un mouvement linéaire qui accentue les sinueuses formes coniques de son corps. Une suspension en métal avec source lumineuse LED – simple et efficace, élégante et très lumineuse, à utiliser seule ou en compositions scénographiques. ● FR

*Rain* kommt von der Decke herab wie ein Regentropfen im Frühling, mit einer linearen Bewegung, die die geschwungenen, konischen Formen des Korpus betont. Eine Aufhängung aus Metall mit LED-Lichtquelle, einfach und effizient, elegant und besonders stark leuchtend, einzeln oder in wirkungsvollen Kombinationen zu verwenden. ● DE

*Rain* cae como una gota de lluvia primaveral del techo, con un movimiento lineal que acentúa las sinuosas formas cónicas de su cuerpo. Colgante de metal con fuente luminosa LED, simple y efectiva, elegante y extremadamente brillante, para usarla sola o en composiciones escénicas. ● ES

Светильник *Rain* спускается с потолка подобно капле весеннего дождя, прямолинейность падения которой оттеняет изгибы конических форм его корпуса. Металлический подвесной светильник с источником света LED – простой и эффективный, элегантный и необыкновенно яркий, для использования отдельно или в композициях со сценическим эффектом. ● RU

*Rain*就如从天花板上滴下的一滴春雨，以线性运动加重了其主体的弯曲圆锥形的外形。具有LED光源的金属悬架简单有效，优雅且非常明亮，可单独使用或在场景中组合使用。● ZH

CATEGORY CLUSTER SUSPENSION LAMP

Rain

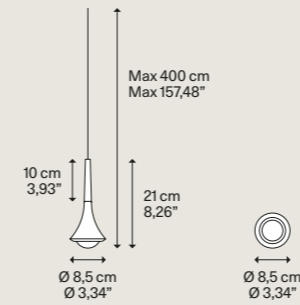

Light source Sorgente luminosa A

LED 2700 K 7 W 1280 lm 350 mA CRI 90 MacAdam 3-Step  
LED and driver included  
LED e driver inclusi

Light source Sorgente luminosa B

LED 3000 K 7 W 1300 lm 350 mA CRI 90 MacAdam 3-Step  
LED and driver included  
LED e driver inclusi

DESIGN Andrea Tosetto, 2015

Metal structure Montatura in metallo

Chrome Cromo

Transparent cable Cavo trasparente

Matte Black – 9005 Nero Opaco – 9005

Black cable Cavo nero

Metal decor Decoro in metallo

Matte Black – 9005 Nero Opaco – 9005

Coppery Bronze Bronzo Ramato

Brushed Chrome Cromo Spazzolato

Gold Oro

Rose Gold Oro Rosa

Matte Black – 9005 Nero Opaco – 9005

Coppery Bronze Bronzo Ramato

Brushed Chrome Cromo Spazzolato

Gold Oro

Rose Gold Oro Rosa

Code Codice A

15611 2027

15611 3527

15611 4727

15611 5027

15611 5527

15612 2027

15612 3527

15612 4727

15612 5027

15612 5527

Code Codice B

15611 2030

15611 3530

15611 4730

15611 5030

15611 5530

15612 2030

15612 3530

15612 4730

15612 5030

15612 5530

Rain ▸ Cluster suspension lamp



Transparent cable and chrome structure

Black cable and black structure



Net weight 0,34 kg / 0,75 lbs | Pack Colli 2 | Energy class Classe energetica C

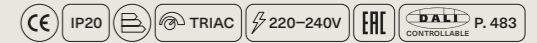

Cluster suspension lamps must be installed on a canopy ▶ P. 318-327  
Le lampade a sospensione cluster devono essere installate su rosone ▶ P. 318-327



# A-Tube Nano

Designed by Studio Italia Design

Year 2016, 2025

*A-Tube Nano* expresses light in its purest form, featuring a suspension lamp that draws a fine line of light through space. The ultra-light aluminum structure, with a slim diameter of just 2 cm, holds a transparent methacrylate diffuser at its lower end, with an internal LED module that emits a soft, enveloping glow. Available in three frame lengths and six versatile finishes, *A-Tube Nano* offers inspiring possibilities for composition – whether as a single light point or clustered in groups to create unique lighting arrangements, suited to various settings and moods in private, contract, and hospitality spaces. In the new recessed ceiling version, the lamp can be adjusted to direct light precisely where needed, enhancing the dramatic effect of multi-element compositions.

*A-Tube Nano* interpreta la luce nella sua forma più pura con una lampada a sospensione che traccia una sottile linea luminosa nello spazio. La leggerissima struttura in alluminio, con un diametro di soli 2 cm, ospita all'estremità inferiore un diffusore in metacrilato trasparente; il modulo LED si trova al suo interno e irradia una luminosità morbida e avvolgente. Disponibile in tre lunghezze di montatura e in sei versatili finiture, *A-Tube Nano* offre suggestive possibilità di composizione, singolarmente come punto luce o su cluster per creare inedite soluzioni luminose adatte a più ambienti e situazioni, sia in ambito privato che nei settori contract e hospitality. Nella nuova versione da soffitto a incasso, la lampada può essere orientata a piacere per direzionare la luce su specifici punti o per enfatizzare l'effetto scenografico di una composizione con più elementi.

Go to the technical info



Click to discover more



A-Tube Nano  
COD. 158

CATEGORY LAMP

Cluster suspension  
Ceiling

Sospensione cluster  
Soffitto



TYPE OF LIGHT

Symmetrical diffused light  
Adjustable light

Luce simmetrica diffusa  
Luce orientabile

NEW



A-Tube Nano cluster suspension and ceiling lamp, FINISH Champagne and Terra.









230 A-Tube Nano large, *recessed micro canopy*, FINISH Terra, black cable version.



A-Tube Nano small, medium and large, FINISH Terra, black cable version.





232 A-Tube Nano large, special composition of 655 lights on recessed micro canopies, FINISH Champagne.

5 special compositions of 80 lights and 5 special compositions of 51 lights.







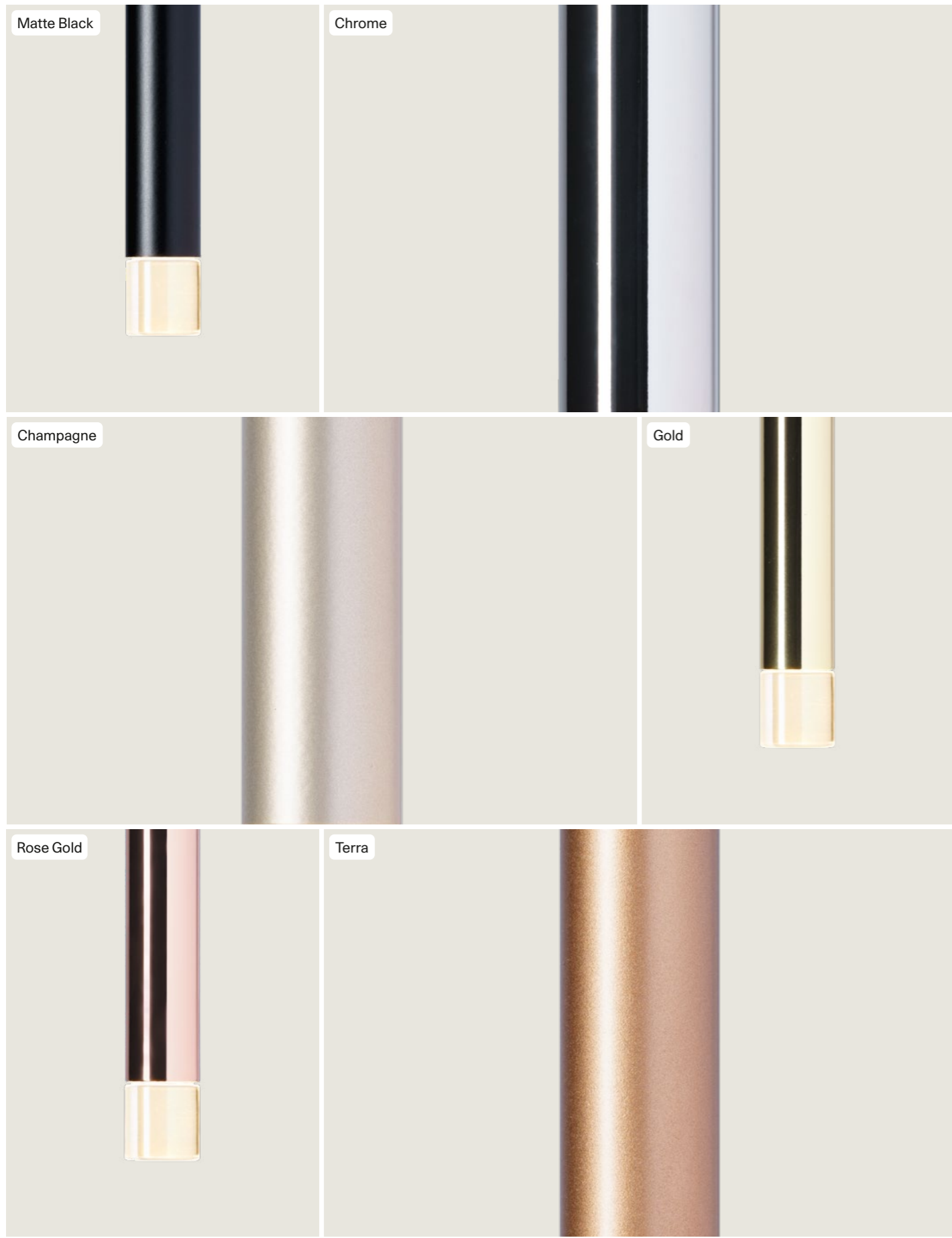

236 A-Tube Nano, metal diffuser finishes.



A-Tube Nano medium, composition of 5 lights on a round canopy, FINISH Matte Black.















A-*Tube Nano* interprète la lumière dans sa forme la plus pure avec une suspension qui trace une fine ligne lumineuse dans l'espace. La structure en aluminium, très légère, d'un diamètre de 2 cm seulement, accueille à l'extrémité inférieure un diffuseur en méthacrylate transparent ; le module LED est situé à l'intérieur et dégage une luminosité douce et enveloppante. Disponible en trois longueurs de montage et en six finitions polyvalentes, A-*Tube Nano* offre des possibilités de composition suggestives, individuellement comme point lumineux ou en cluster pour obtenir de nouvelles solutions d'éclairage adaptées à une multitude d'ambiances et de situations, tant dans le secteur privé que dans le contract et accueil. Dans la nouvelle version intégrée au plafond, la suspension peut être orientée pour diriger le faisceau lumineux sur des points spécifiques ou pour valoriser l'effet scénographique d'une composition à plusieurs éléments. ●FR

A-*Tube Nano* interpreta la luz en su forma más pura con una lámpara de suspensión que traza una fina línea de luz en el espacio. La estructura de aluminio extremadamente ligera y de sólo 2 cm de diámetro, alberga en el extremo inferior un difusor de metacrilato transparente; el módulo LED se encuentra en su interior e irradia una luminosidad suave y envolvente. Disponible en tres longitudes de cuerpo y seis versátiles acabados, A-*Tube Nano* ofrece sugerentes posibilidades de composición, individualmente como punto de luz o en cluster para crear novedosas soluciones de iluminación adecuadas para distintos entornos y situaciones, tanto en el ámbito privado como en los sectores del contract y la hostelería. En la nueva versión de techo empotrada, la lámpara puede orientarse como se desee para dirigir la luz a puntos concretos o para acentuar el efecto escénico de una composición con varios elementos. ●ES

A-*Tube Nano*通过一款悬吊灯以最纯粹的形式诠释光线,这款悬吊灯在空间中描绘出一条纤细的发光线条。直径仅为2厘米的铝制结构非常轻巧,下端装有一盏透明的甲基丙烯酸酯灯罩;LED模块位于灯罩内部,散发出一股柔和和包络的光亮。共有三种框架长度和六种多用饰面供您选择,A-*Tube Nano*提供迷人多姿的组构可能性,可单独作为光点或置于灯座上创建全新照明解决方案。无论是在私人环境还是在定制领域或酒店业内,这款灯件都能适合不同环境与情况。在全嵌入式吸顶灯版本中,灯件可按喜好定向,以将光线引导到特定点上,或彰显多元素组合的场景效果。●ZH

A-*Tube Nano* interpretiert das Licht in seiner reinsten Form mit einer Hängeleuchte, die einen feinen Lichtstreifen im Raum zeichnet. In der ultraleichten Struktur aus Aluminium mit einem Durchmesser von nur 2 cm, befindet sich am unteren Ende ein transparenter Methacrylatdiffusor; das in seinem Inneren befindliche LED-Modul strahlt eine angenehme und umhüllende Helligkeit aus. Erhältlich in drei Rahmenlängen und sechs vielseitigen Ausführungen, bietet A-*Tube Nano* faszinierende Kompositionsmöglichkeiten als einzelner Lichtpunkt oder in Clustern, um neuartige Beleuchtungslösungen zu schaffen, die sich für eine Vielzahl von Umgebungen und Situationen eignen, sowohl im privaten als auch im Contract- und Hospitality Bereich. In der neuen Ausführung als Deckeneinbau kann die Leuchte beliebig ausgerichtet werden, um das Licht auf bestimmte Punkte zu lenken oder um den szenischen Effekt einer Komposition mit mehreren Elementen zu betonen. ●DE

Подвесная лампа A-*Tube Nano* интерпретирует свет в его чистой форме, очерчивая тонкую светящуюся линию в пространстве. Внутри очень легкой алюминиевой конструкции диаметром всего 2 см на нижнем конце расположен диффузор из прозрачного метакрилата; находящийся внутри светодиодный модуль излучает мягкий и обволакивающий свет. Доступный в трех вариантах длины оправы и шести универсальных вариантах отделки, A-*Tube Nano* предлагает огромные возможности для композиции, отдельно в виде световой точки или в форме кластеров, для создания необычных световых решений, подходящих для различных помещений и ситуаций, как в частном секторе, так и в коммерческих и гостиничных структурах. В новой встраиваемой потолочной версии светильник можно ориентировать по желанию, чтобы направить свет на определенные точки или подчеркнуть сценорафический эффект композиции, состоящей из нескольких элементов. ●RU

A-*Tube Nano* Swing, adjustable lamp.

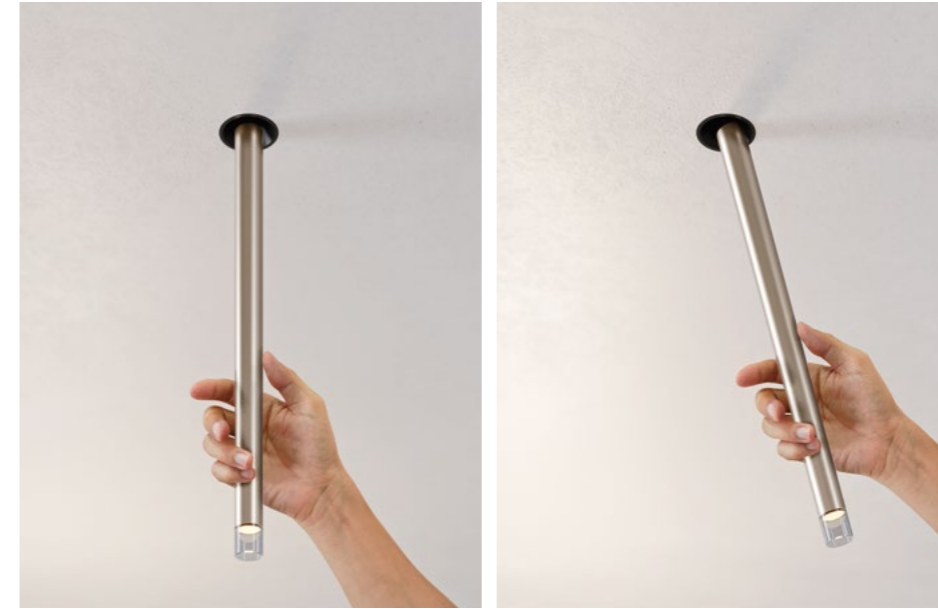

A-*Tube Nano* small ↘ Cluster suspension lamp

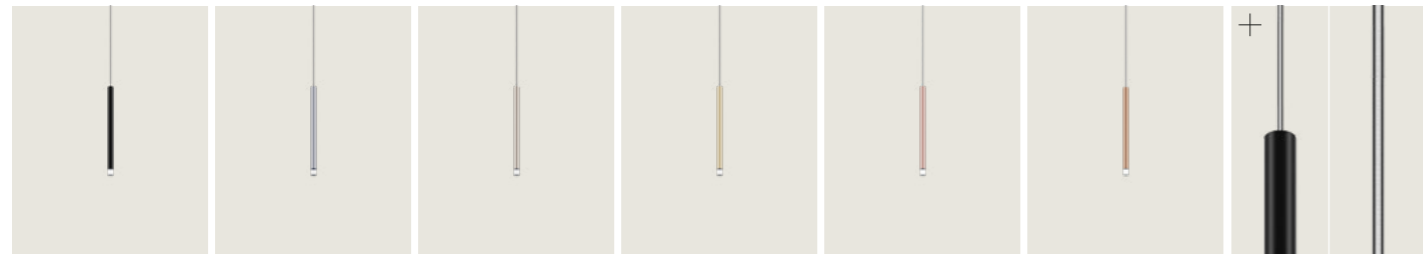

↘ Transparent cable

A-*Tube Nano* medium ↘ Cluster suspension lamp

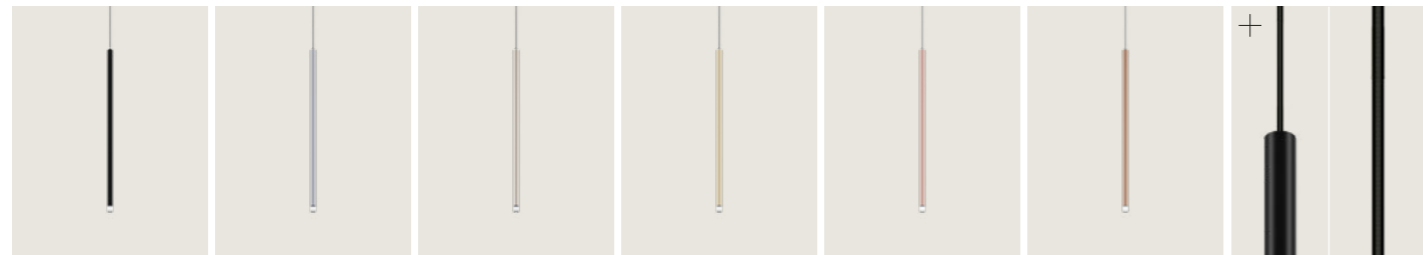

↘ Black cable

A-*Tube Nano* large ↘ Cluster suspension lamp

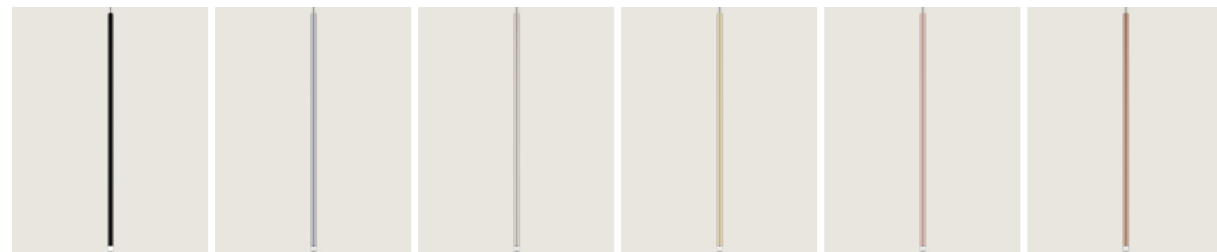

A-*Tube Nano* Swing small ↘ Ceiling lamp **NEW LAMP**

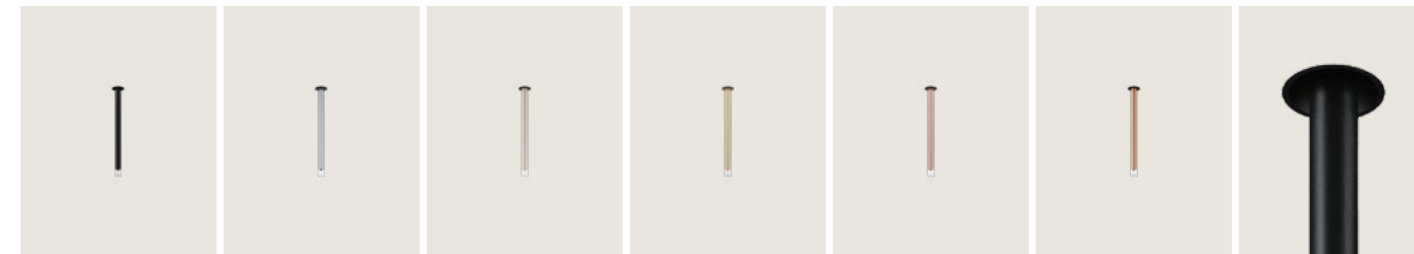

Recessed canopy (included)

A-*Tube Nano* Swing medium ↘ Ceiling lamp **NEW LAMP**



A-*Tube Nano* Swing large ↘ Ceiling lamp **NEW LAMP**





CATEGORY CLUSTER SUSPENSION LAMP

A-Tube Nano small

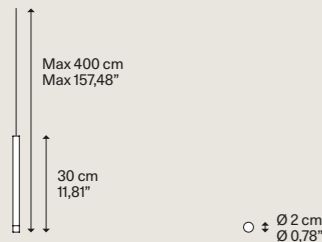

Light source Sorgente luminosa <b>A</b>		Light source Sorgente luminosa <b>B</b>	
LED 2700 3 450 350 CRI 90 MacAdam 3-Step	K W lm mA	LED 3000 3 480 350 CRI 90 MacAdam 3-Step	K W lm mA
LED and driver included LED e driver inclusi		LED and driver included LED e driver inclusi	

Net weight Peso netto	0,22 kg 0,48 lbs	Pack Colli	2	Energy class Classe energetica	D
--------------------------	---------------------	---------------	---	-----------------------------------	---

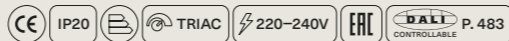

DESIGN Studio Italia Design, 2016

Metal structure Montatura in metallo	Methacrylate diffuser Diffusore in metacrilato	Code Codice <b>A</b>	Code Codice <b>B</b>
Matte Black-9005 Nero Opaco-9005		15822 2020	15822 2035
Chrome Cromo		15822 4020	15822 4035
Champagne Champagne		15822 4520	15822 4535
Gold Oro	Clear Trasparente	15822 5020	15822 5035
Rose Gold Oro Rosa		15822 5520	15822 5535
Terra Terra	Transparent cable Cavo trasparente	15822 6720	15822 6735
Matte Black-9005 Nero Opaco-9005		15826 2020	15826 2035
Chrome Cromo		15826 4020	15826 4035
Champagne Champagne		15826 4520	15826 4535
Gold Oro	Clear Trasparente	15826 5020	15826 5035
Rose Gold Oro Rosa		15826 5520	15826 5535
Terra Terra	Black cable Cavo nero	15826 6720	15826 6735

CATEGORY CLUSTER SUSPENSION LAMP

A-Tube Nano large

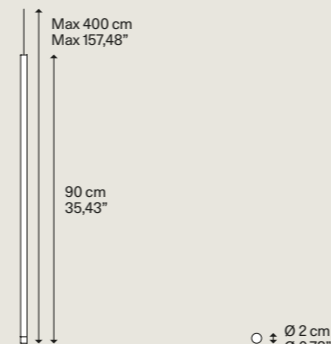

Light source Sorgente luminosa <b>A</b>		Light source Sorgente luminosa <b>B</b>	
LED 2700 3 450 350 CRI 90 MacAdam 3-Step	K W lm mA	LED 3000 3 480 350 CRI 90 MacAdam 3-Step	K W lm mA
LED and driver included LED e driver inclusi		LED and driver included LED e driver inclusi	

Net weight Peso netto	0,40 kg 0,88 lbs	Pack Colli	2	Energy class Classe energetica	D
--------------------------	---------------------	---------------	---	-----------------------------------	---

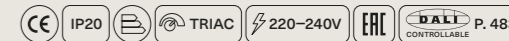

DESIGN Studio Italia Design, 2016

Metal structure Montatura in metallo	Methacrylate diffuser Diffusore in metacrilato	Code Codice <b>A</b>	Code Codice <b>B</b>
Matte Black-9005 Nero Opaco-9005		15824 2020	15824 2035
Chrome Cromo		15824 4020	15824 4035
Champagne Champagne		15824 4520	15824 4535
Gold Oro	Clear Trasparente	15824 5020	15824 5035
Rose Gold Oro Rosa		15824 5520	15824 5535
Terra Terra	Transparent cable Cavo trasparente	15824 6720	15824 6735
Matte Black-9005 Nero Opaco-9005		15828 2020	15828 2035
Chrome Cromo		15828 4020	15828 4035
Champagne Champagne		15828 4520	15828 4535
Gold Oro	Clear Trasparente	15828 5020	15828 5035
Rose Gold Oro Rosa		15828 5520	15828 5535
Terra Terra	Black cable Cavo nero	15828 6720	15828 6735

Cluster suspension lamps must be installed on a canopy ► P. 318-327  
Le lampade a sospensione cluster devono essere installate su rosone ► P. 318-327

A-Tube Nano medium

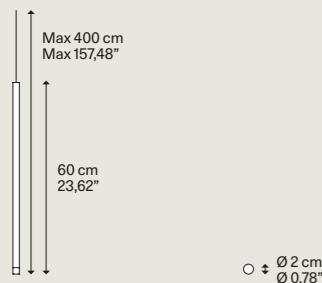

Light source Sorgente luminosa <b>A</b>		Light source Sorgente luminosa <b>B</b>	
LED 2700 3 450 350 CRI 90 MacAdam 3-Step	K W lm mA	LED 3000 3 480 350 CRI 90 MacAdam 3-Step	K W lm mA
LED and driver included LED e driver inclusi		LED and driver included LED e driver inclusi	

Net weight Peso netto	0,30 kg 0,66 lbs	Pack Colli	2	Energy class Classe energetica	D
--------------------------	---------------------	---------------	---	-----------------------------------	---

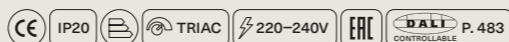

Cluster suspension lamps must be installed on a canopy ► P. 318-327  
Le lampade a sospensione cluster devono essere installate su rosone ► P. 318-327



CATEGORY RECESSED CEILING LAMP NEW LAMP

DESIGN Studio Italia Design, 2025

### A-Tube Nano Swing small

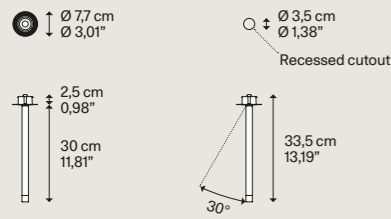

Metal structure Montatura in metallo	Methacrylate diffuser Diffusore in metacrilato	Code Codice	A	Code Codice	B
Matte Black-9005 Nero Opaco-9005	Clear Trasparente	15832 2020		15832 2035	
Chrome Cromo		15832 4020		15832 4035	
Champagne Champagne		15832 4520		15832 4535	
Gold Oro		15832 5020		15832 5035	
Rose Gold Oro Rosa		15832 5520		15832 5535	
Terra Terra		15832 6720		15832 6735	

Light source Sorgente luminosa	A	Light source Sorgente luminosa	B
LED 2700 3 450 350 CRI 90 MacAdam 3-Step	K W lm mA	LED 3000 3 480 350 CRI 90 MacAdam 3-Step	K W lm mA
LED and driver included LED e driver inclusi		LED and driver included LED e driver inclusi	

Net weight Peso netto	0,68 kg 1,49 lbs	Pack Colli	2	Energy class Classe energetica	D
--------------------------	---------------------	---------------	---	-----------------------------------	---

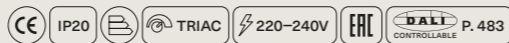

NEW LAMP

### A-Tube Nano Swing medium

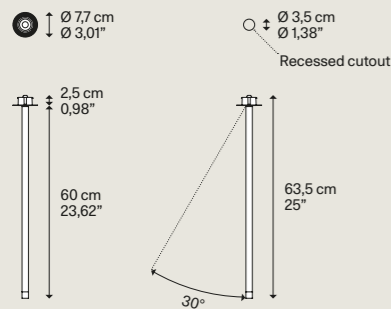

Metal structure Montatura in metallo	Methacrylate diffuser Diffusore in metacrilato	Code Codice	A	Code Codice	B
Matte Black-9005 Nero Opaco-9005	Clear Trasparente	15833 2020		15833 2035	
Chrome Cromo		15833 4020		15833 4035	
Champagne Champagne		15833 4520		15833 4535	
Gold Oro		15833 5020		15833 5035	
Rose Gold Oro Rosa		15833 5520		15833 5535	
Terra Terra		15833 6720		15833 6735	

Light source Sorgente luminosa	A	Light source Sorgente luminosa	B
LED 2700 3 450 350 CRI 90 MacAdam 3-Step	K W lm mA	LED 3000 3 480 350 CRI 90 MacAdam 3-Step	K W lm mA
LED and driver included LED e driver inclusi		LED and driver included LED e driver inclusi	

Net weight Peso netto	0,76 kg 1,67 lbs	Pack Colli	2	Energy class Classe energetica	D
--------------------------	---------------------	---------------	---	-----------------------------------	---

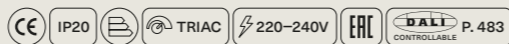

CATEGORY RECESSED CEILING LAMP NEW LAMP

DESIGN Studio Italia Design, 2025

### A-Tube Nano Swing large

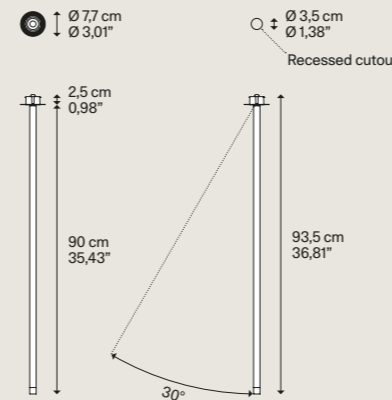

Metal structure Montatura in metallo	Methacrylate diffuser Diffusore in metacrilato	Code Codice	A	Code Codice	B
Matte Black-9005 Nero Opaco-9005	Clear Trasparente	15834 2020		15834 2035	
Chrome Cromo		15834 4020		15834 4035	
Champagne Champagne		15834 4520		15834 4535	
Gold Oro		15834 5020		15834 5035	
Rose Gold Oro Rosa		15834 5520		15834 5535	
Terra Terra		15834 6720		15834 6735	

Light source Sorgente luminosa	A	Light source Sorgente luminosa	B
LED 2700 3 450 350 CRI 90 MacAdam 3-Step	K W lm mA	LED 3000 3 480 350 CRI 90 MacAdam 3-Step	K W lm mA
LED and driver included LED e driver inclusi		LED and driver included LED e driver inclusi	

Net weight Peso netto	0,86 kg 1,89 lbs	Pack Colli	2	Energy class Classe energetica	D
--------------------------	---------------------	---------------	---	-----------------------------------	---



### Adjustable light Luce orientabile

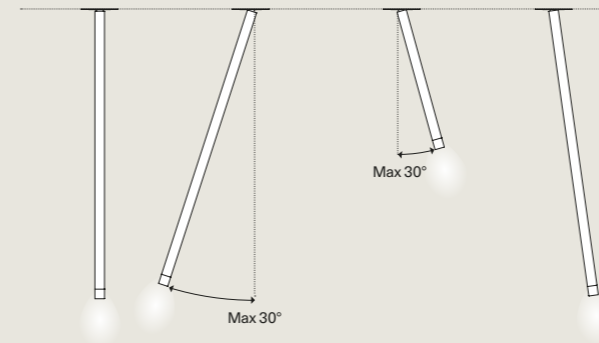



# A-Tube Nano Duo

Designed by Studio Italia Design

Year 2017

Precious pins suspended from a thin cable, like magic lights floating in the space. *A-Tube Nano Duo* is an offshoot of *A-Tube Nano* with an LED light source on both ends of its thin metal body. A lightweight and linear lamp available in six finishes, including the new Terra, which allows to create evocative and playful cluster compositions.

Preziose barrette sospese ad un cavo sottile, come magiche luci che galleggiano nello spazio. *A-Tube Nano Duo* è una variante di *A-Tube Nano* con sorgente luminosa a LED su entrambe le estremità del sottile corpo metallico. Una lampada leggera e lineare disponibile in sei finiture, inclusa la nuova tonalità Terra, con le quali si possono realizzare suggestive e giocose composizioni su cluster.



Go to the technical info 

Click to discover more 

A-Tube Nano Duo  
COD. 158

CATEGORY LAMP

Cluster suspension

Sospensione cluster

TYPE OF LIGHT

Symmetrical diffused light

Luce simmetrica diffusa









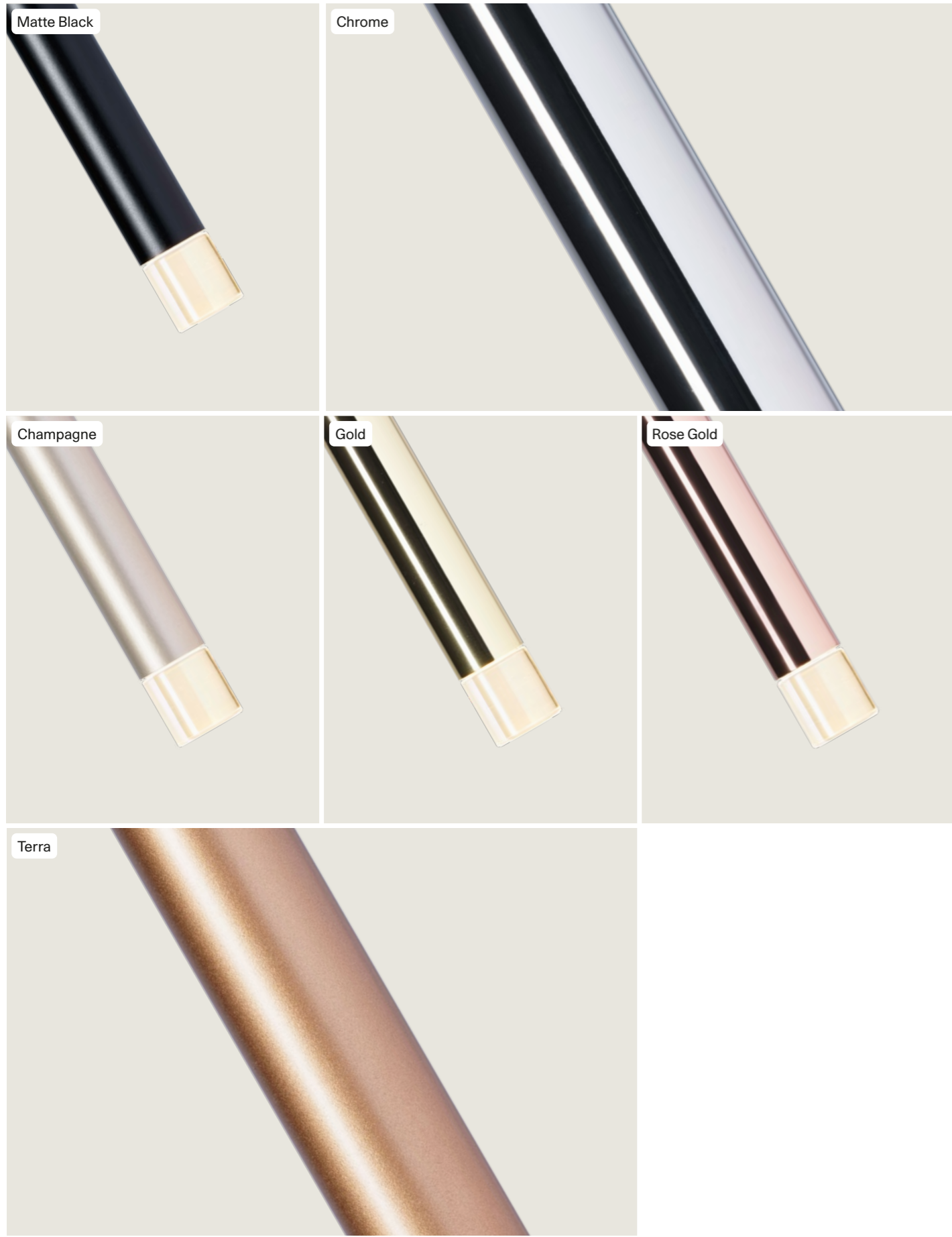







De précieuses barres suspendues à un câble fin, comme des lumières magiques flottant dans l'espace. *A-Tube Nano Duo* est une variante de *A-Tube Nano* avec une source de lumière LED aux deux extrémités du fin corps métallique. Une lampe légère et linéaire disponible en six finitions, comprenant la nouvelle tonalité Terra, qui permettent de créer des compositions en cluster, évocatrices et ludiques. ●FR

Wertvolle Balken, die an einem schmalen Kabel hängen, wie magisches Licht, das im Raum schwebt. *A-Tube Nano Duo* ist eine Variante von *A-Tube Nano* mit LED-Lichtquelle an beiden Enden des dünnen Metallkorpus. Eine leichte und lineare Leuchte, in sechs Ausführungen verfügbar, darunter auch der neue Farbton Terra, mit denen wunderbare und verspielte Cluster-Kombinationen geschaffen werden können. ●DE

Preciosas barras suspendidas de un fino cable, como luces mágicas que flotan en el espacio. *A-Tube Nano Duo* es una variante de *A-Tube Nano* con fuente luminosa de LED en ambos extremos del sutil cuerpo de metal. Una lámpara ligera y lineal disponible en seis acabados, incluido el nuevo tono Tierra, con los que se pueden crear sugestivas y divertidas composiciones en grupos de lámparas de suspensión. ●ES

Изящные трубки, подвешенные на тонком кабеле, – словно волшебные огни, парящие в пространстве. Светильник *A-Tube Nano Duo* является вариантом *A-Tube Nano* с источником света LED на обоих концах тонкого металлического корпуса. Легкая прямолинейная лампа доступна в шести вариантах отделки, включая новую тональность Terra, с использованием которых можно создавать очаровательные и живые кластерные композиции. ●RU

通过细细的电缆线将贵重的条形悬挂起来，就像漂浮在太空中的魔幻灯一样。*A-Tube Nano Duo*是*A-Tube Nano*的变型，在纤薄金属主体的两端均带有LED光源。这是一种轻巧的线性灯，有包含全新大地色调在内的六种颜色，可以在组合吊上创建富有启发性和趣味性的构造。●ZH

## CATEGORY CLUSTER SUSPENSION LAMP

## A-Tube Nano Duo

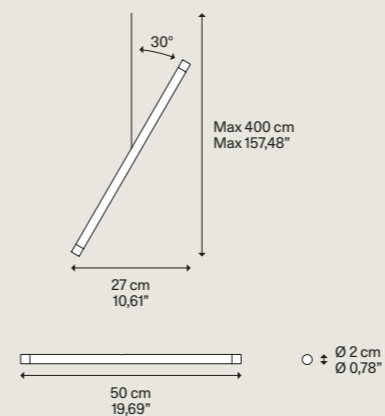
Light source  
Sorgente luminosa

LED  
2700 K  
2x 1 W  
280 lm  
350 mA  
CRI 90  
MacAdam 3-Step  
LED and driver included  
LED e driver inclusi

Net weight	0,21 kg	Pack	1	Energy class	D
Peso netto	0,46 lbs	Colli		Classe energetica	

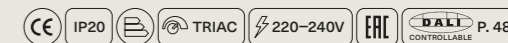

Cluster suspension lamps must be installed on a canopy ► P. 318–327  
Le lampade a sospensione cluster devono essere installate su rosone ► P. 318–327

## DESIGN Studio Italia Design, 2017

Metal structure  
Montatura in metallo

- Matte Black – 9005  
Nero Opaco – 9005
- Chrome  
Cromo
- Champagne  
Champagne
- Gold  
Oro
- Rose Gold  
Oro Rosa
- Terra  
Terra

Methacrylate diffuser  
Diffusore in metacrilato

- Clear  
Trasparente
- Transparent cable  
Cavo trasparente

Code  
Codice

- 15825 2020
- 15825 4020
- 15825 4520
- 15825 5020
- 15825 5520
- 15825 6720

A-Tube Nano Duo » Cluster suspension lamp





# A-*Tube*

Designed by Studio Italia Design

Year 2013

A simple form that delivers the light to wherever it's needed, enhancing the space. Tubular and slim, *A-*Tube** is a versatile lamp available in four different sizes and three finishes. It can be fixed directly to the ceiling, suspended singularly, or used in cluster compositions to create impactful lighting effects.

Una forma semplice, che porta la luce dove si desidera valorizzando l'ambiente. Tubolare e sottile, *A-*Tube** è una lampada versatile, disponibile in diverse dimensioni e in tre finiture. Può essere fissata direttamente al soffitto, sospesa singolarmente, oppure utilizzata in composizioni cluster d'effetto.



Go to the technical info [+](#) Click to discover more [↓](#)

A-*Tube*  
COD. 096

CATEGORY LAMP

Cluster suspension  
Ceiling

Sospensione cluster  
Soffitto



TYPE OF LIGHT

Symmetrical diffused light

Luce simmetrica diffusa











Une forme simple, qui éclaire où vous le souhaitez tout en valorisant l'environnement. Tubulaire et fine, *A-Tube* est une lampe polyvalente, disponible en différentes dimensions et trois finitions. Elle peut être fixée directement au plafond, suspendue individuellement ou utilisée en compositions cluster. ●FR

Eine einfache Form, die das Licht in jenen Bereich des Raums bringt, der betont werden soll. Röhrenförmig und dünn, ist *A-Tube* eine vielseitige Lampe, die in verschiedenen Größen und drei Ausführungen verfügbar ist. Sie kann direkt an der Decke befestigt werden, einzeln hängend, oder zu wirkungsvollen Clustern kombiniert. ●DE

Una forma simple, que lleva la luz donde se desea valorizando el ambiente. Tubular y sutil, la *A-Tube* es una lámpara versátil, disponible en diferentes tamaños y tres acabados. Puede fijarse directamente al techo, suspenderse individualmente o utilizarse en composiciones de grupos de lámparas colgantes de efecto. ●ES

Простая незамысловатая форма, несущая свет туда, где это необходимо, и украшающая интерьер. Светильник *A-Tube* в форме тонкой изящной трубки является необыкновенно универсальным и доступен с разными размерами и с тремя типами отделки. Его можно крепить непосредственно к потолку, повесить отдельно или использовать в качестве эффектных кластерных композиций. ●RU

外形简洁，可将光线照射到想要的地方。*A-Tube*呈管状且细长，是一种多功能灯，有不同尺寸和三种颜色可供选择。它可以直接吸顶安装，可以单独悬吊安装，也可以组合吊式安装。●ZH



A-Tube mini ↘ Ceiling lamp

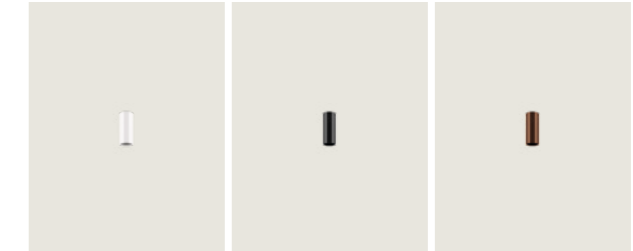

A-Tube small ↘ Cluster suspension lamp



A-Tube small ↘ Ceiling lamp

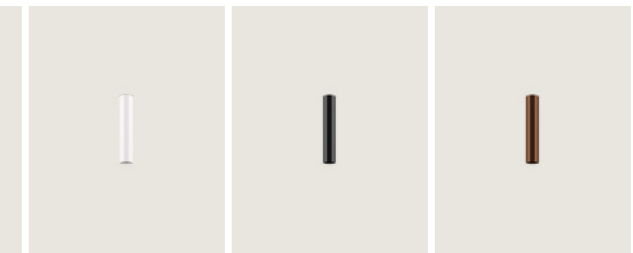

A-Tube medium ↘ Cluster suspension lamp



A-Tube medium ↘ Ceiling lamp

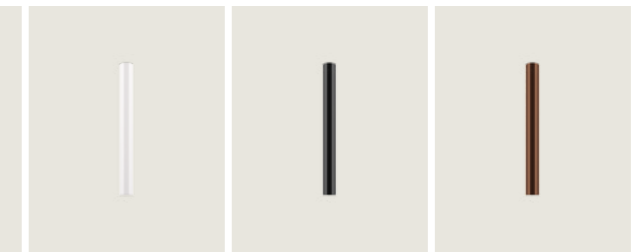

A-Tube large ↘ Cluster suspension lamp



A-Tube large ↘ Ceiling lamp

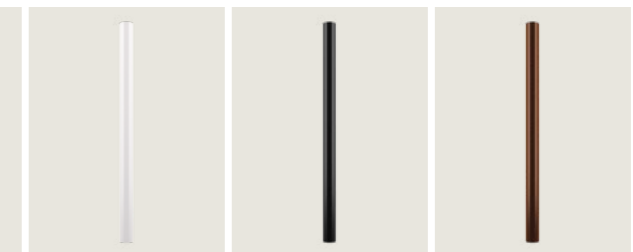



## CATEGORY CLUSTER SUSPENSION LAMP

DESIGN Studio Italia Design, 2013

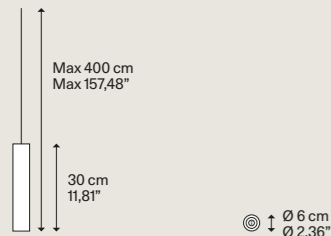
A-Tube small

Net weight	1,12 kg	Pack	1
Peso netto	2,47 lbs	Colli	

Light source  
Sorgente luminosa

GU10 Par 16 LED  
1 × 10 W

W/L max 8,5 cm  
W/L max 3,34"

Bulb not included  
Lampadina non inclusa

Metal structure  
Montatura in metallo

Matte White - 9010  
Bianco Opaco - 9010

Matte Black - 9005  
Nero Opaco - 9005

Coppery Bronze  
Bronzo Ramato

Code  
Codice

09622 1000

09622 2000

09622 3500

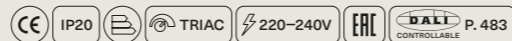
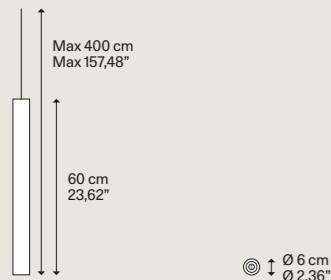
A-Tube medium

Net weight	1,42 kg	Pack	1
Peso netto	3,13 lbs	Colli	

Light source  
Sorgente luminosa

GU10 Par 16 LED  
1 × 10 W

W/L max 8,5 cm  
W/L max 3,34"

Bulb not included  
Lampadina non inclusa

Metal structure  
Montatura in metallo

Matte White - 9010  
Bianco Opaco - 9010

Matte Black - 9005  
Nero Opaco - 9005

Coppery Bronze  
Bronzo Ramato

Code  
Codice

09623 1000

09623 2000

09623 3500

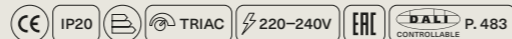
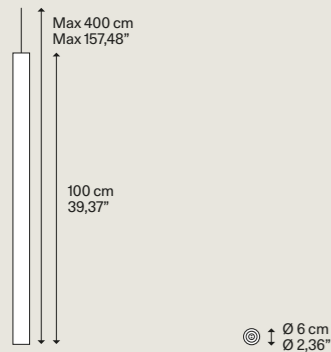
A-Tube large

Net weight	1,87 kg	Pack	1
Peso netto	4,12 lbs	Colli	

Light source  
Sorgente luminosa

GU10 Par 16 LED  
1 × 10 W

W/L max 8,5 cm  
W/L max 3,34"

Bulb not included  
Lampadina non inclusa

Metal structure  
Montatura in metallo

Matte White - 9010  
Bianco Opaco - 9010

Matte Black - 9005  
Nero Opaco - 9005

Coppery Bronze  
Bronzo Ramato

Code  
Codice

09624 1000

09624 2000

09624 3500

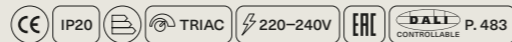

Cluster suspension lamps must be installed on a canopy ► p. 318-327  
Le lampade a sospensione cluster devono essere installate su rosone ► p. 318-327

## CATEGORY CEILING LAMP

DESIGN Studio Italia Design, 2013

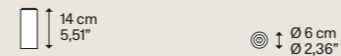
A-Tube mini

Net weight	0,20 kg	Pack	1
Peso netto	0,44 lbs	Colli	

Light source  
Sorgente luminosa

GU10 Par 16  
1 × 10 W

W/L max 9 cm  
W/L max 3,54"

Bulb not included  
Lampadina non inclusa

Metal structure  
Montatura in metallo

Matte White - 9010  
Bianco Opaco - 9010

Matte Black - 9005  
Nero Opaco - 9005

Coppery Bronze  
Bronzo Ramato

Code  
Codice

09631 1000

09631 2000

09631 3500

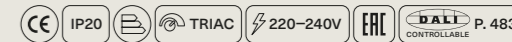
A-Tube small

Net weight	0,80 kg	Pack	1
Peso netto	1,76 lbs	Colli	

Light source  
Sorgente luminosa

GU10 Par 16  
1 × 10 W

W/L max 9 cm  
W/L max 3,54"

Bulb not included  
Lampadina non inclusa

Metal structure  
Montatura in metallo

Matte White - 9010  
Bianco Opaco - 9010

Matte Black - 9005  
Nero Opaco - 9005

Coppery Bronze  
Bronzo Ramato

Code  
Codice

09632 1000

09632 2000

09632 3500

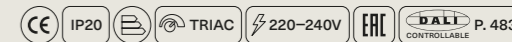
A-Tube medium

Net weight	0,90 kg	Pack	1
Peso netto	1,98 lbs	Colli	

Light source  
Sorgente luminosa

GU10 Par 16  
1 × 10 W

W/L max 9 cm  
W/L max 3,54"

Bulb not included  
Lampadina non inclusa

Metal structure  
Montatura in metallo

Matte White - 9010  
Bianco Opaco - 9010

Matte Black - 9005  
Nero Opaco - 9005

Coppery Bronze  
Bronzo Ramato

Code  
Codice

09633 1000

09633 2000

09633 3500

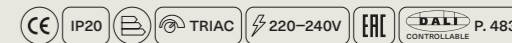
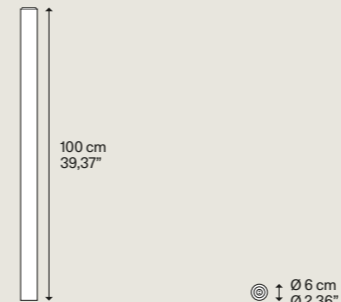
A-Tube large

Net weight	1,50 kg	Pack	1
Peso netto	3,31 lbs	Colli	

Light source  
Sorgente luminosa

GU10 Par 16  
1 × 10 W

W/L max 9 cm  
W/L max 3,54"

Bulb not included  
Lampadina non inclusa

Metal structure  
Montatura in metallo

Matte White - 9010  
Bianco Opaco - 9010

Matte Black - 9005  
Nero Opaco - 9005

Coppery Bronze  
Bronzo Ramato

Code  
Codice

09634 1000

09634 2000

09634 3500

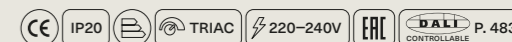



# IVY I and V

Designed by Vittorio Massimo

Year 2022



*IVY* is a minimal, geometric lighting piece composed of a die-cast zinc alloy ring hanging on a black cable, which gives power to a made to measure LED module. The product sheds an even, rounded light beam through its thin and curved methacrylate diffuser. Designed with single and double cables, *IVY* responds to the need for flexibility, an increasingly contemporary theme in architectural practice and restoration, allowing the luminaire to be released from its ceiling derivation. Imagining the repetition and clustering of several lamps suggested the name *IVY*, while the ring reminds of a precious pendant on a necklace.

*IVY* è una lampada dalle linee minimaliste e geometriche costituita da un anello in lega di zinco pressofuso sospeso ad un cavo nero che aziona un modulo a LED realizzato su misura. Il prodotto emette un fascio di luce uniforme e omogeneo attraverso il sottile diffusore curvo in metacrilato. Dotata di cavi singoli e doppi, *IVY* risponde alla crescente esigenza di flessibilità nell'attuale contesto delle attività architettoniche e di ristrutturazione, consentendo di riposizionare la lampada rispetto alla fonte di alimentazione a soffitto. L'idea della ripetizione e del raggruppamento di più lampade ha ispirato il nome *IVY*, dall'inglese "edera", mentre l'anello richiama il prezioso ciondolo di una collana.



Go to the technical info [+](#) Click to discover more [↓](#)

IVY I and V  
COD. 178

CATEGORY LAMP		TYPE OF LIGHT	
Suspension	Sospensione	Symmetrical diffused light	Luce simmetrica diffusa
Cluster suspension	Sospensione cluster		
			













276 IVY V, composition of 6 lights on a *central canopy*, FINISH Matte Black.



IVY V, FINISH Matte Black.







IVY est un élément d'éclairage minimaliste et géométrique fait d'un anneau en alliage de zinc moulé sous pression, suspendu à un câble noir qui alimente un module LED sur mesure. Le produit diffuse un faisceau lumineux uniforme et arrondi grâce à son diffuseur en méthacrylate fin et incurvé. Conçu avec des câbles simples et doubles, IVY répond au besoin de flexibilité, un thème de plus en plus contemporain dans la pratique architecturale et la restauration, permettant au luminaire d'être libéré de sa dérivation de plafond. Le nom IVY, anglais pour « lierre », s'inspire du regroupement de plusieurs lampes en cluster, tandis que l'anneau rappelle le précieux pendentif d'un collier. ● FR

IVY ist ein minimalistisches, geometrisches Beleuchtungsobjekt, bestehend aus einem Ring aus druckgegossener Zinklegierung, aufgehängt an einem schwarzen Kabel, das ein maßgefertigtes LED-Modul mit Strom versorgt. Das Produkt wirft einen gleichmäßigen, runden Lichtstrahl durch seinen dünnen und gebogenen Methacrylat-Diffusor. Entworfen mit einzelnen und doppelten Kabeln ist IVY die Antwort auf das Bedürfnis nach Flexibilität, ein zunehmend aktuelles Thema in der architektonischen Praxis und Restauration, das es der Leuchte ermöglicht, sich von ihrer Deckenableitung zu lösen. Die Vorstellung von der Wiederholung und Cluster mit mehreren Leuchten inspirierten zu dem Namen IVY, englisch für „Efeu“, während der Ring an einen kostbaren Anhänger einer Halskette erinnert. ● DE

IVY es un elemento de iluminación minimalista y geométrico compuesto de un aro de aleación de cinc fundido que cuelga de un cable negro, el cual alimenta a un módulo LED hecho a medida. La lámpara proyecta un haz de luz redondeado y homogéneo a través de su fino y curvado difusor de metacrilato. Diseñada con cables individuales y dobles, IVY responde a la necesidad de flexibilidad, una temática cada vez más de actualidad en la arquitectura y la restauración, que permite liberar el punto de luz de su derivación en el techo. El nombre IVY, «hiedra» en inglés, sugiere la repetición y la agrupación de varias lámparas, mientras que su aro recuerda al colgante de un collar. ● ES

IVY – это минималистичный геометрический осветительный элемент, состоящий из литого под давлением кольца, выполненного из цинкового сплава, подвешенного на черном кабеле, подающем питание к индивидуально изготовленному светодиодному модулю. Лампа излучает ровный круглый световой луч, проходящий через тонкий и изогнутый диффузор из метакрилата. Спроектированная с использованием одинарных и двойных кабелей, лампа IVY отвечает потребности в универсальности, все более актуальной в современной архитектуре и реконструкциях, позволяя освободить светильник от связи с потолком. Образ повторяющихся и объединенных в кластер ламп подсказал название IVY, что в переводе с английского означает «плющ», само кольцо напоминает драгоценный кулон на колье. ● RU

IVY是一款极简几何照明件,由一只悬挂于一根黑色线缆上的压铸铝合金圆环组成,线缆可为定制型LED模块供电。该产品通过其细薄而弯曲的甲基丙烯酸酯灯罩散发均匀的圆形光束。采用单线缆和双线缆设计,IVY回应了对灵活性的需求,这是建筑实践与装修中一个日趋现代的主题,可将灯具重新定位于一个与位于天花板的电源处有所不同的地方。IVY之名建立在对更多灯件的重复和组吊的想象中,而圆环则令人忆起项链上的精美吊坠。● ZH

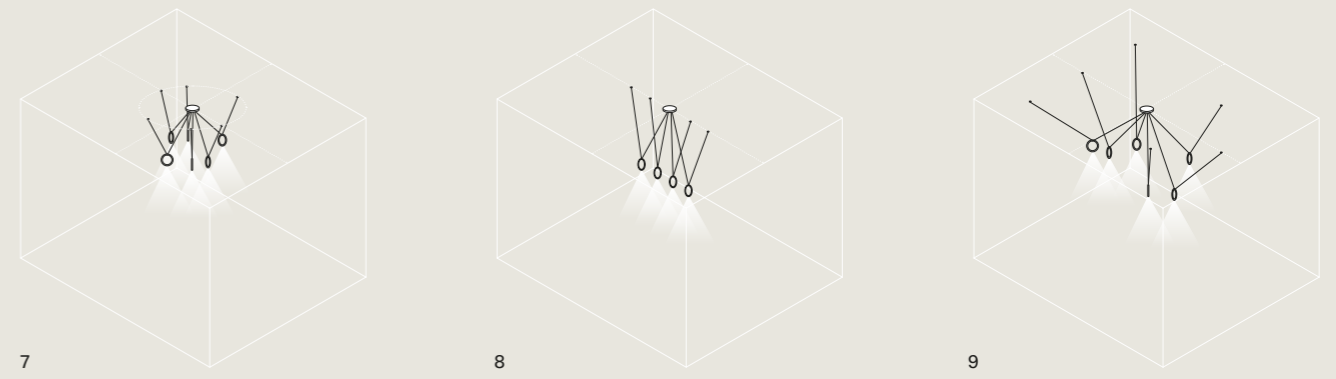
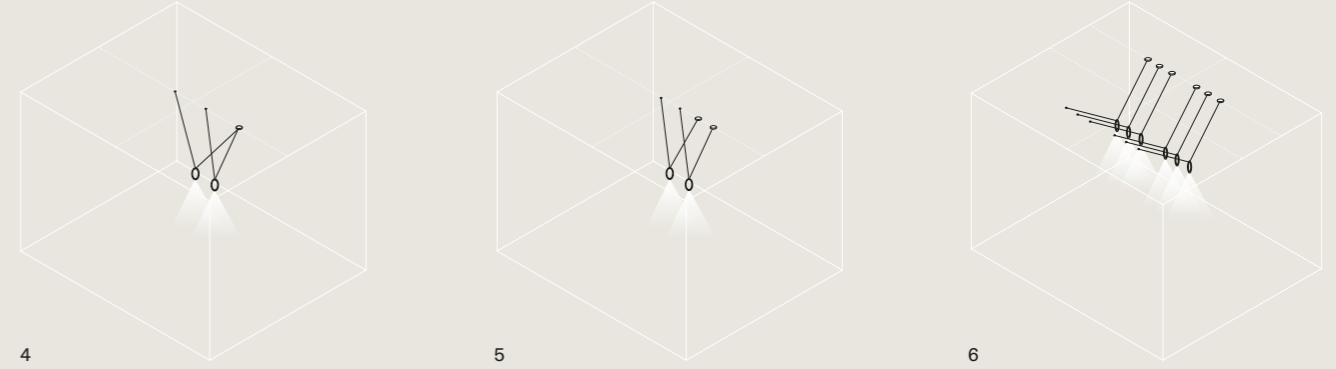
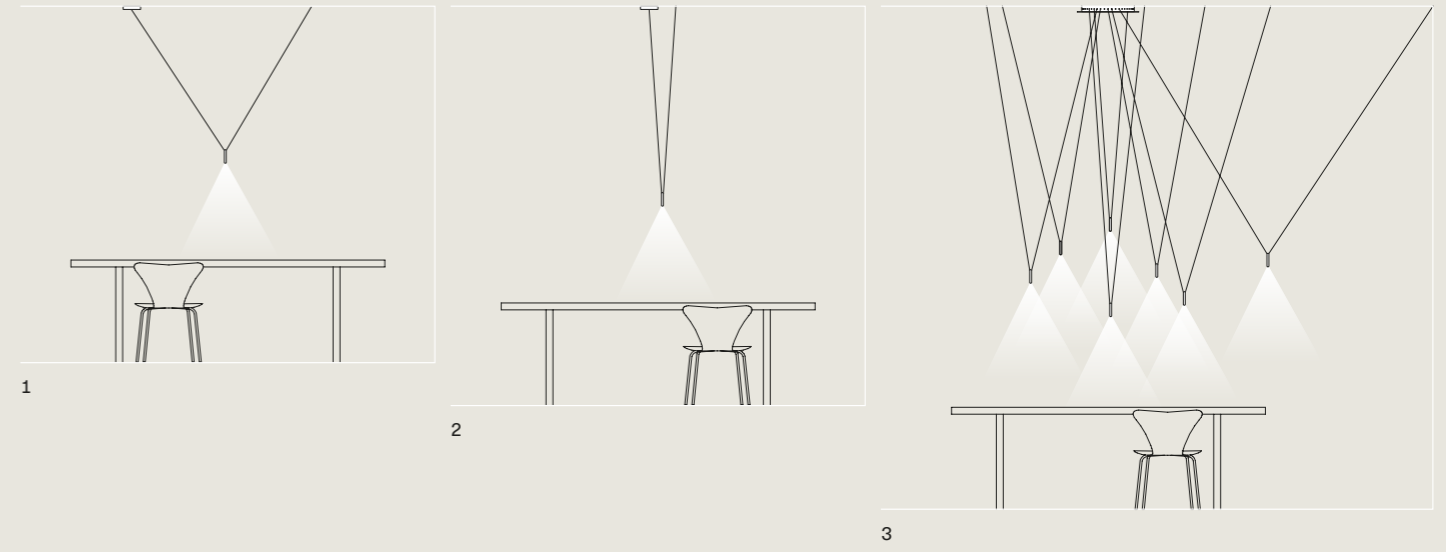

IVY I ▸ Cluster suspension lamp

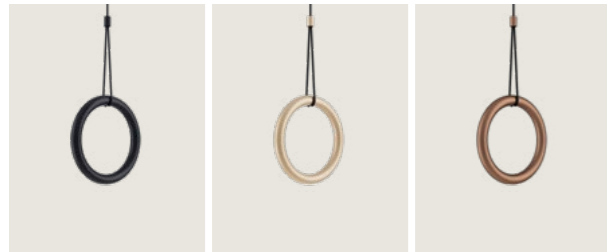

IVY V ▸ Central cluster suspension lamp, Suspension lamp

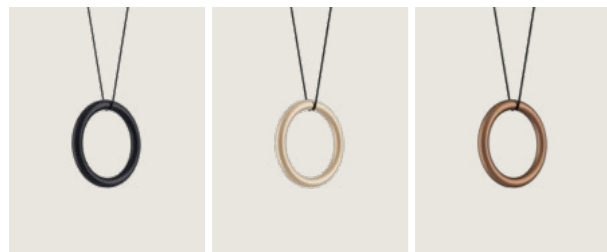



CATEGORY CLUSTER SUSPENSION LAMP

DESIGN Vittorio Massimo, 2022

IVY I

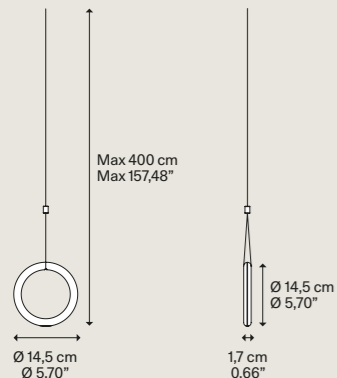

Metal structure Montatura in metallo	Cable Cavo	Code Codice	A	Code Codice	B
● Matte Black - 9005 Nero Opaco - 9005		17810 2020		17810 2035	
● Extra Matte Champagne Champagne Extra Opaco	● Black Nero	17810 4520		17810 4535	
● Terra Terra		17810 6720		17810 6735	

**Light source**  
Sorgente luminosa

**A**

LED	
2700	K
3	W
450	lm
350	mA
CRI 90	
MacAdam 3-Step	

LED and driver included  
LED e driver inclusi

**Light source**  
Sorgente luminosa

**B**

LED	
3000	K
3	W
480	lm
350	mA
CRI 90	
MacAdam 3-Step	

LED and driver included  
LED e driver inclusi

Net weight Peso netto	0,50 kg 1,10 lbs	Pack Colli	1	Energy class Classe energetica	2700 K ▶ D 3000 K ▶ C
--------------------------	---------------------	---------------	---	-----------------------------------	--------------------------

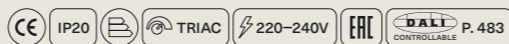

Cluster suspension lamps must be installed on a canopy ▶ p. 318-327  
Le lampade a sospensione cluster devono essere installate su rosone ▶ p. 318-327

CATEGORY CENTRAL CLUSTER SUSPENSION LAMP

DESIGN Vittorio Massimo, 2022

IVY V

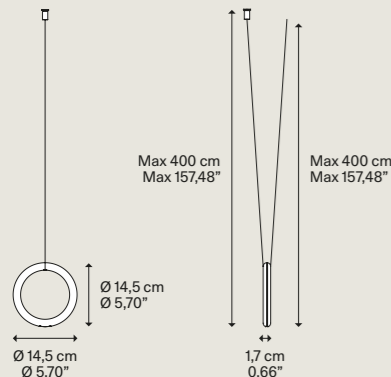

Metal structure Montatura in metallo	Cable Cavo	Code Codice	A	Code Codice	B
● Matte Black - 9005 Nero Opaco - 9005		17820 2020		17820 2035	
● Extra Matte Champagne Champagne Extra Opaco	● Black Nero	17820 4520		17820 4535	
● Terra Terra		17820 6720		17820 6735	

**Light source**  
Sorgente luminosa

**A**

LED	
2700	K
3	W
450	lm
350	mA
CRI 90	
MacAdam 3-Step	

LED and driver included  
LED e driver inclusi

**Light source**  
Sorgente luminosa

**B**

LED	
3000	K
3	W
480	lm
350	mA
CRI 90	
MacAdam 3-Step	

LED and driver included  
LED e driver inclusi

Net weight Peso netto	0,58 kg 1,27 lbs	Pack Colli	1	Energy class Classe energetica	2700 K ▶ D 3000 K ▶ C
--------------------------	---------------------	---------------	---	-----------------------------------	--------------------------

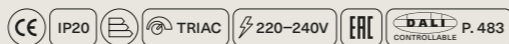

IVY V cluster suspension lamps must only be installed on the single and central canopies below  
Le lampade a sospensione cluster IVY V devono essere installate solamente sui rosini singoli e centrali di seguito

CATEGORY SINGLE CANOPY

Single Mini

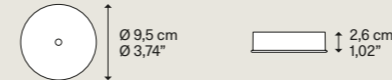

Net weight Peso netto	0,13 kg 0,28 lbs	Pack Colli	1
--------------------------	---------------------	---------------	---

CATEGORY RECESSED CANOPY

Recessed Micro

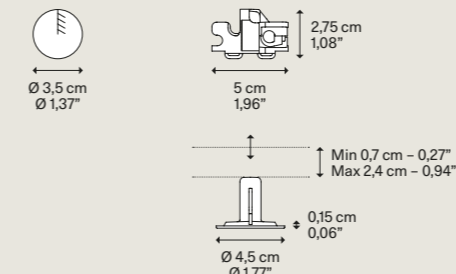

Net weight Peso netto	0,015 kg 0,033 lbs	Pack Colli	1
--------------------------	-----------------------	---------------	---

Recessed Micro Trimless

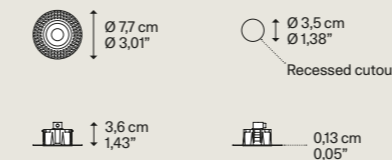

Net weight Peso netto	0,12 kg 0,26 lbs	Pack Colli	1
--------------------------	---------------------	---------------	---

CATEGORY CENTRAL CANOPY

6 Lights Central

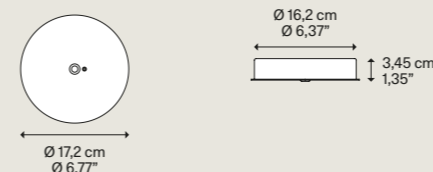

Net weight Peso netto	0,58 kg 1,27 lbs	Pack Colli	1
--------------------------	---------------------	---------------	---

12 Lights Central

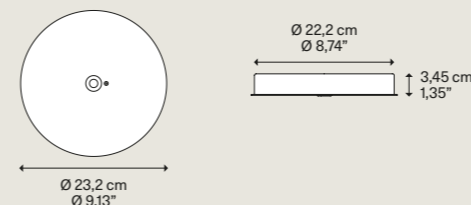

Net weight Peso netto	1,00 kg 2,20 lbs	Pack Colli	1
--------------------------	---------------------	---------------	---

Description Descrizione	Methacrylate structure Struttura in metacrilato	System Sistema	Code Codice
Single ceiling canopy small size	● Matte Black - 9005 Nero Opaco - 9005	Single	R11L01 2000



Description Descrizione	Methacrylate structure Struttura in metacrilato	System Sistema	Code Codice
Recessed canopy for single lamp max capacity 3,5 kg - 7,71 lbs	● Matte Black - 9005 Nero Opaco - 9005	Recessed	R01L01 2000

Rosone da incasso per  
lampada singola portata  
max 3,5 kg - 7,71 lbs

Description Descrizione	Methacrylate structure Struttura in metacrilato	System Sistema	Code Codice
Recessed canopy Trimless available in Pure and Deep versions for single lamp.	● Matte Black - 9005 Nero Opaco - 9005	Recessed	R13L01 2000

Rosone da incasso a  
scomparsa (Trimless)  
in versione Pure e Deep  
per lampada singola.



Description Descrizione	Metal structure Struttura in metallo	System Sistema	Code Codice
Central canopy max 6 suspension	● Matte Black - 9005 Nero Opaco - 9005	Cluster Central	R07L06 2000

Rosone centrale  
max 6 sospensioni



Description Descrizione	Metal structure Struttura in metallo	System Sistema	Code Codice
Central canopy max 12 suspension	● Matte Black - 9005 Nero Opaco - 9005	Cluster Central	R07L12 2000

Rosone centrale  
max 12 sospensioni



Recessed Micro ▶ Suitable for ceilings up to 2,4 cm - 0,94" thickness.

Recessed Micro ▶ Adatta per soffitti fino a 2,4 cm - 0,94" di spessore.



# JIM

Designed by Patrick Norguet

Year 2021

Immediate function, uncomplicated style, durable materials, modular at will. Inspired by the abat-jours of the ateliers of the early 1900s, *JIM* is a system of suspension lamps with distinctive shapes and a versatile composition that suits any interiors and living environment. *JIM's* versatility is further enhanced by the colour range: the two finishes for the shades can be combined with the two different suspension hook hues as desired.

Immediatezza di funzione, semplicità delle linee, materiali durevoli, componibilità a piacere. Ispirato ai paralumi degli atelier di artisti dell'inizio del 1900, *JIM* è un sistema di lampade a sospensione dalle forme distintive e dalla composizione versatile che si adatta a qualsiasi interno e ambiente abitativo. La versatilità di *JIM* è ulteriormente valorizzata dalla gamma cromatica: le due finiture disponibili per i paralumi possono essere combinate a piacere con le due diverse tonalità del gancio a cui è sospesa la lampada.



[Go to the technical info](#) 
[Click to discover more](#) 

JIM  
COD. 169

CATEGORY LAMP

Suspension  
Cluster suspension

Sospensione  
Sospensione cluster



TYPE OF LIGHT

Symmetrical diffused light

Luce simmetrica diffusa







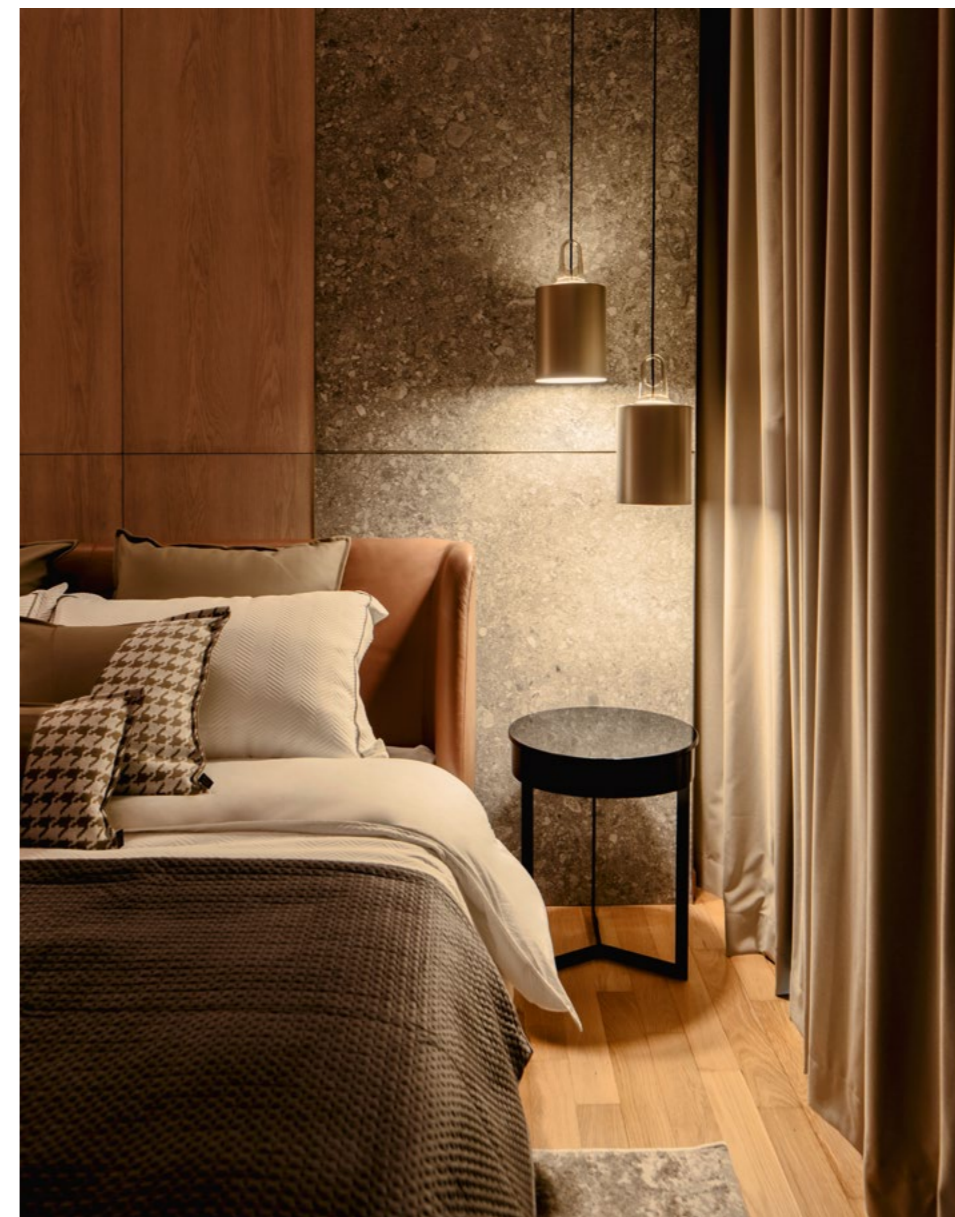









Immédiateté de fonction, simplicité des lignes, matériaux durables, infinie modularité. S'inspirant des abat-jours des ateliers d'artistes du début du XXe siècle, *JIM* est un système de suspensions arborant des formes distinctives et une composition polyvalente qui s'adapte à tous les styles d'habitation. La gamme chromatique souligne encore plus la polyvalence de *JIM* : les deux finitions disponibles pour les diffuseurs peuvent s'assortir, au choix, aux deux différentes tonalités du crochet de soutien. ●FR

Unmittelbarkeit der Funktion, Einfachheit der Linien, haltbare Materialien, Modularität nach Belieben. Inspiriert an den Lampenschirmen der Künstlerateliers der frühen 1900er Jahre, ist *JIM* ein Hängeleuchtsystem mit unverwechselbaren Formen und vielseitiger Gestaltungsmöglichkeit, das sich an jedes Interieur und jede Wohnumgebung anpasst. Die Vielseitigkeit von *JIM* wird durch die Farbpalette noch verstärkt: Die zwei erhältlichen Ausführungen der Lampenschirme können beliebig mit den zwei verschiedenen Farbtönen des Hakens, an dem die Leuchte aufgehängt wird, kombiniert werden. ●DE

Inmediatez de función, líneas sencillas, materiales duraderos y libertad de modularidad. Inspirado en las pantallas de los ateliers de artistas de principios del siglo XX, *JIM* es un sistema de lámparas de suspensión con formas características y una composición versátil que se adapta a cualquier interior y ambiente. La versatilidad de *JIM* la valoriza aún más la gama cromática: los dos acabados disponibles para las pantallas se pueden combinar libremente con los dos tonos del gancho en el que está suspendida la lámpara. ●ES

Немедленно доступная функциональность, несложный стиль, прочные материалы, модульность по желанию. Лампа воспроизводит стиль абажуров творческих ателье начала 1900-х. *JIM* представляет собой систему подвесных ламп особой формы, с универсальной композицией, подходящей для любых внутренних интерьеров и дизайна жилья. Универсальность *JIM* дополнительно расширена благодаря диапазону цветов: две отделки абажуров сочетаются по желанию с двумя разными тональностями подвесных крюков. ●RU

功能即时、风格简洁、材料耐用、组合随意。灵感源于二十世纪初期艺术家工坊中的灯罩，*JIM*是一款形状独特且组合多样的悬吊灯系统，适宜于任何室内装饰与家居环境。*JIM*的通用性以其色彩范围之广越发增值：灯罩的两种饰面可按喜好与悬灯钩的两种不同色调相搭配。●ZH

JIM bell ↘ Cluster suspension lamp

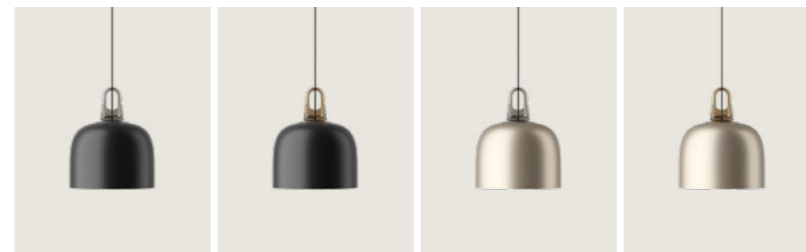

JIM cone ↘ Cluster suspension lamp



JIM cylinder ↘ Cluster suspension lamp

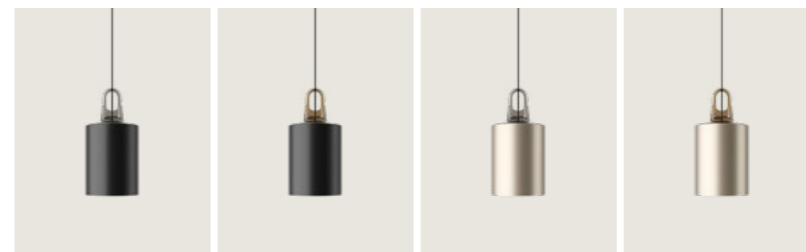

JIM dome ↘ Suspension lamp

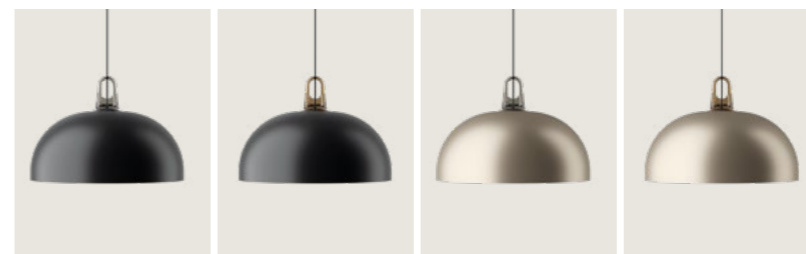

Grey hook  
Gancio Grigio

Honey hook  
Gancio Miele





CATEGORY CLUSTER SUSPENSION LAMP

DESIGN Patrick Norguet, 2021

JIM bell

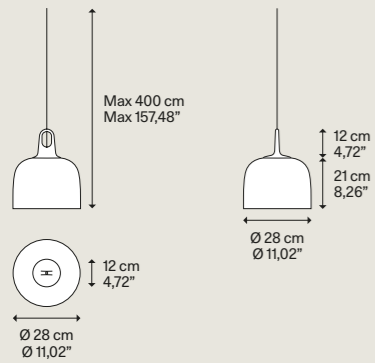

Net weight 1,90 kg / 4,19 lbs  
Pack Colli 2

Outside metal diffuser Diff. esterno in metallo	Inside metal diffuser Diff. interno in metallo	Hook methacrylate Gancio in metacrilato	Code Codice
● Matte Black - 9005 Nero Opaco - 9005	● Matte White - 9010 Bianco Opaco - 9010	● Grey Grigio	16921 2800
		● Honey Miele	16921 6600
● Champagne Champagne	● Matte White - 9010 Bianco Opaco - 9010	● Grey Grigio	16921 2700
		● Honey Miele	16921 6500

Light source  
Sorgente luminosa

E27 A60 LED  
1 x Max 25 W

Bulb not included  
Lampadina non inclusa



CATEGORY SUSPENSION LAMP

DESIGN Patrick Norguet, 2021

JIM dome

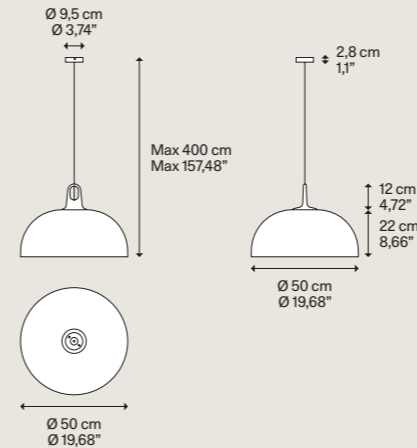

Net weight 2,20 kg / 4,85 lbs  
Pack Colli 2

Outside metal diffuser Diff. esterno in metallo	Inside metal diffuser Diff. interno in metallo	Hook methacrylate Gancio in metacrilato	Code Codice
● Matte Black - 9005 Nero Opaco - 9005	● Matte White - 9010 Bianco Opaco - 9010	● Grey Grigio	16924 2800
		● Honey Miele	16924 6600
● Champagne Champagne	● Matte White - 9010 Bianco Opaco - 9010	● Grey Grigio	16924 2700
		● Honey Miele	16924 6500

Light source  
Sorgente luminosa

E27 A60 LED  
1 x Max 25 W

Bulb not included  
Lampadina non inclusa

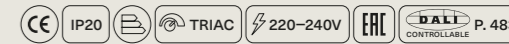

JIM cone

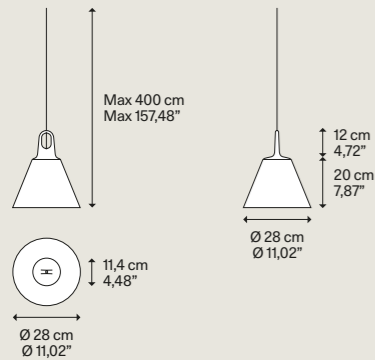

Net weight 1,00 kg / 2,20 lbs  
Pack Colli 2

Outside metal diffuser Diff. esterno in metallo	Inside metal diffuser Diff. interno in metallo	Hook methacrylate Gancio in metacrilato	Code Codice
● Matte Black - 9005 Nero Opaco - 9005	● Matte White - 9010 Bianco Opaco - 9010	● Grey Grigio	16922 2800
		● Honey Miele	16922 6600
● Champagne Champagne	● Matte White - 9010 Bianco Opaco - 9010	● Grey Grigio	16922 2700
		● Honey Miele	16922 6500

Light source  
Sorgente luminosa

E27 A60 LED  
1 x Max 25 W

Bulb not included  
Lampadina non inclusa



JIM cylinder

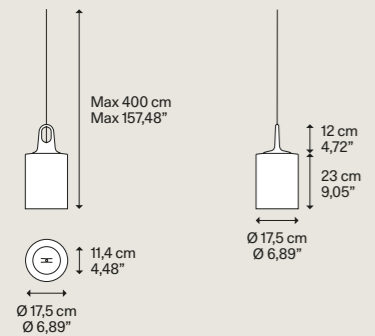

Net weight 1,40 kg / 3,09 lbs  
Pack Colli 2

Outside metal diffuser Diff. esterno in metallo	Inside metal diffuser Diff. interno in metallo	Hook methacrylate Gancio in metacrilato	Code Codice
● Matte Black - 9005 Nero Opaco - 9005	● Matte White - 9010 Bianco Opaco - 9010	● Grey Grigio	16923 2800
		● Honey Miele	16923 6600
● Champagne Champagne	● Matte White - 9010 Bianco Opaco - 9010	● Grey Grigio	16923 2700
		● Honey Miele	16923 6500

Light source  
Sorgente luminosa

E27 A60 LED  
1 x Max 25 W

Bulb not included  
Lampadina non inclusa



Cluster suspension lamps must be installed on a canopy ► P. 318-327  
Le lampade a sospensione cluster devono essere installate su rosone ► P. 318-327



# Kelly Cluster

Designed by Andrea Toso

Year 2015

*Kelly Cluster* spectacularly reinterprets the creative intuition of the family of *Kelly* lights in a sculptural and extremely compact sphere, mounted on a canopy and allowing multiple different compositions at will. A suspension lamp in metal, characterised by its lightness and vibrancy thanks to the unique laser cuts that create captivating plays of light and shadow, it is available in four different finishes bringing any space to life.

*Kelly Cluster* riformula brillantemente l'intuizione creativa della famiglia di lampade *Kelly* in una sfera sculturale ed estremamente compatta che, montata su rosone, permette di realizzare composizioni multiple a piacere. Lampada a sospensione in metallo, leggera e vivace grazie ai particolari tagli a laser che creano affascinanti giochi di luci e ombre, è disponibile in quattro diverse finiture in grado di far risaltare qualsiasi ambiente.



[Go to the technical info](#) 
[Click to discover more](#) 

Kelly Cluster  
COD. 147

CATEGORY LAMP		TYPE OF LIGHT	
Cluster suspension	Sospensione cluster	Symmetrical diffused light	Luce simmetrica diffusa
			













Kelly Cluster, special composition, FINISHES Matte White and Coppery Bronze.



*Kelly Cluster* reformule brillamment l'intuition créative de la famille de lampes *Kelly* dans une sphère sculpturale et extrêmement compacte qui, montée sur une patère, permet de réaliser d'innombrables compositions. Lampe à suspension en métal, légère et animée grâce aux originales découpes laser qui créent de fascinants jeux de lumière et d'ombres ; plusieurs finitions disponibles pour valoriser tous les espaces. ● FR

*Kelly Cluster* formuliert die kreative Intuition der Leuchtenfamilie *Kelly* auf brillante Weise in einer skulpturellen und besonders kompakten Kugel wieder, die auf einem Baldachin montiert die Umsetzung verschiedener Kombinationen nach Wahl ermöglicht. Hängeleuchte aus Metall, die dank besonderer Laserschnitte leicht und lebhaft ist. Sie sorgen außerdem für faszinierende Spiele aus Licht und Schatten. Die Leuchte ist in vier verschiedenen Ausführungen erhältlich, um jeden Raum aufzuwerten. ● DE

*Kelly Cluster* reformula brillantemente la intuición creativa de la familia de lámparas *Kelly* en una esfera escultural y extremadamente compacta que, montada en un florón, permite crear múltiples composiciones a voluntad. Lámpara colgante de metal, ligera y alegre gracias a los cortes especiales de láser que crean fascinantes juegos de luz y sombra, está disponible en cuatro acabados diferentes capaces de resaltar cualquier ambiente. ● ES

*Kelly Cluster* блестяще обыгрывает в новом ключе творческую интуицию, воплощенную в семействе светильников *Kelly*, выполненных в скульптурной и необыкновенно компактной форме шара, монтируя который на потолочное крепление можно создавать множественные композиции на свой вкус. Металлический подвесной светильник с изящным и динамичным дизайном благодаря особым прорезям, выполненным методом лазерной резки и создающим чарующую игру света и тени, доступен в четырёх разных вариантах отделки, которые украсят любой интерьер. ● RU

*Kelly Cluster*在一个雕塑般紧凑的球体中巧妙地重新构造了*Kelly*灯家族系列的创意直觉，该球体安装在底盘上，可让您根据需要创建多种组合。金属制成的吊灯，光线明亮、活泼，这要归功于其特殊的激光切割工艺，可以产生引人入胜的光影效果，并提供四种不同的颜色，可以烘托任何环境。● ZH

## CATEGORY CLUSTER SUSPENSION LAMP

## Kelly Cluster

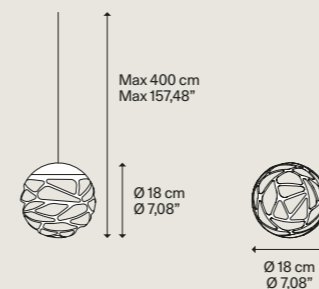

## DESIGN Andrea Tosetto, 2015

Metal structure  
Montatura in metallo

- Matte White - 9010  
Bianco Opaco - 9010
- Matte Black - 9005  
Nero Opaco - 9005
- Coppery Bronze  
Bronzo Ramato
- Champagne  
Champagne

Glass diffuser  
Diffusore in vetro

- Glossy White  
Bianco Lucido

Code  
Codice

- 14711 1027
- 14711 2027
- 14711 3527
- 14711 4527

Light source  
Sorgente luminosa

LED  
2700 K  
7 W  
1280 lm  
350 mA  
CRI 90  
MacAdam 3-Step

LED and driver included  
LED e driver inclusi

Net weight Peso netto	1,00 kg 2,20 lbs	Pack Colli	1	Energy class Classe energetica	C
--------------------------	---------------------	---------------	---	-----------------------------------	---

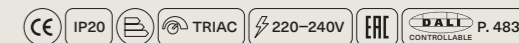

Cluster suspension lamps must be installed on a canopy ► P. 318-327  
Le lampade a sospensione cluster devono essere installate su rosone ► P. 318-327

Kelly Cluster ▾ Cluster suspension lamp

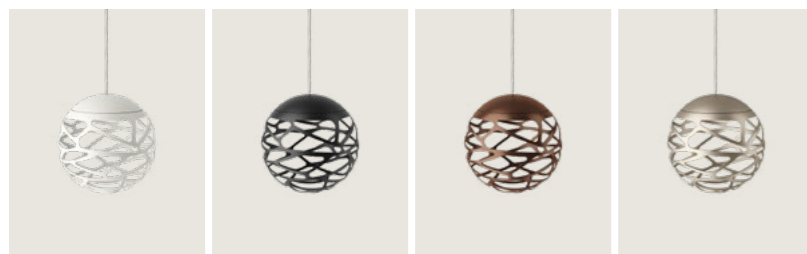



# Cono di Luce

Designed by Ron Arad

Year 2023



*Cono di Luce*, is a unique object, a synthesis of Lodes' cutting-edge know-how and Ron Arad's creativity. It's a lamp characterised by a transparent Pyrex cone that houses a printed circuit board (PCB) inside and a frame, also made of PCB. Another distinctive element of *Cono di Luce* is the customisable frame that holds the sheet placed inside the cone, and which bears the name of the product. The frame details both Arad's and Lodes' names. The lamp, while being strongly characterising, fits into contexts ranging from residential settings to public hospitality spaces rather than food & beverage.

*Cono di Luce*, è un oggetto unico nel suo genere, sintesi del know-how d'avanguardia di Lodes e della creatività firmata Ron Arad. È una lampada caratterizzata da un cono di Pirex trasparente che alloggia al suo interno un foglio con un circuito stampato (PCB) e una montatura, anch'essa in PCB. Ulteriore elemento distintivo di *Cono di Luce* è la cornice che personalizza il foglio posto all'interno del cono e che porta il nome del prodotto, la firma del designer e il nome dell'azienda. La lampada pur essendo fortemente caratterizzante, grazie alla sua estetica dal tratto deciso, si inserisce sia in contesti che spaziano da ambienti residenziali a spazi pubblici hospitality piuttosto che food & beverage.



Go to the technical info [+](#) Click to discover more [↓](#)

Cono di Luce  
cod. 210

CATEGORY LAMP		TYPE OF LIGHT	
Cluster suspension Table	Sospensione cluster Tavolo	Diffused light	Luce diffusa
			







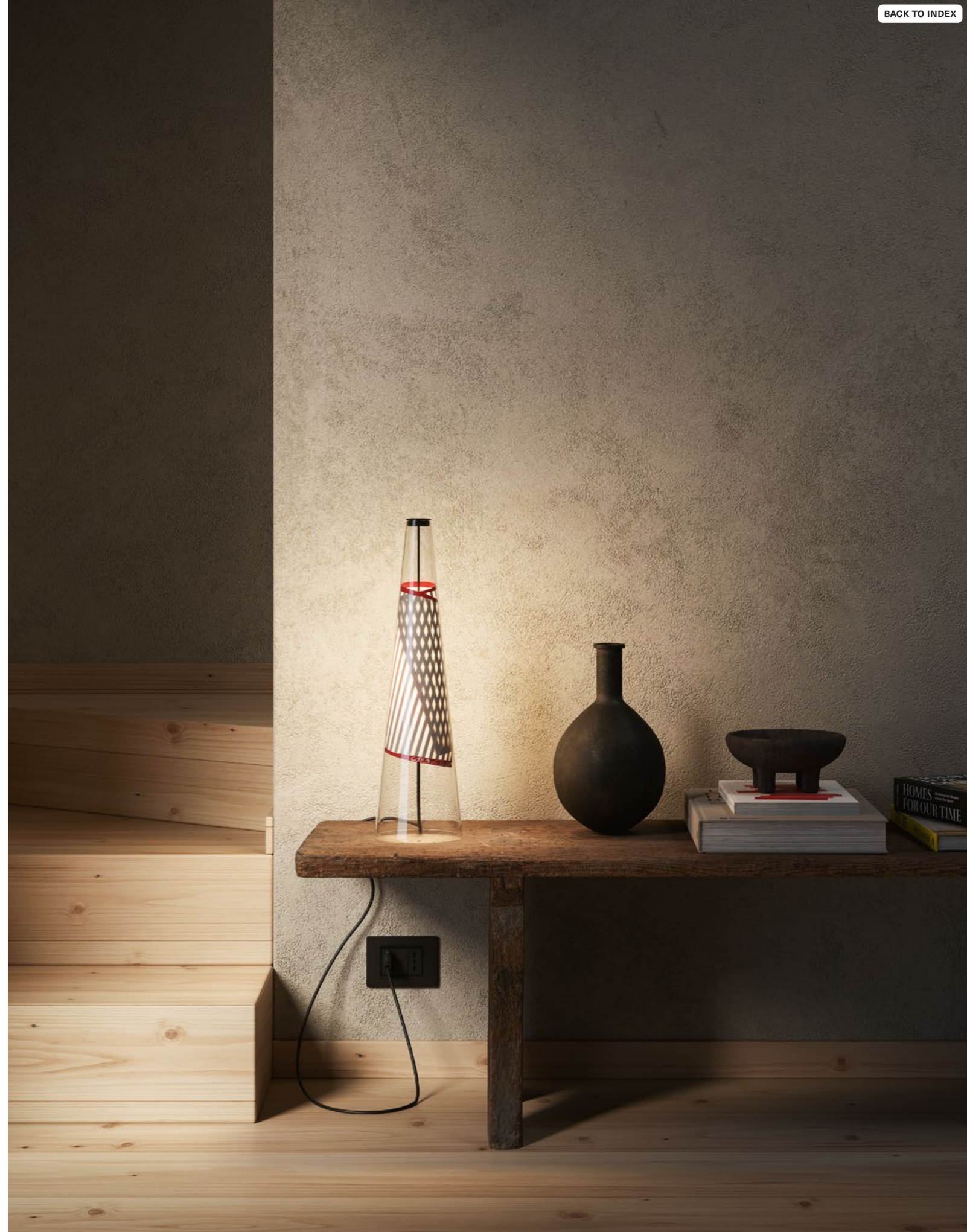







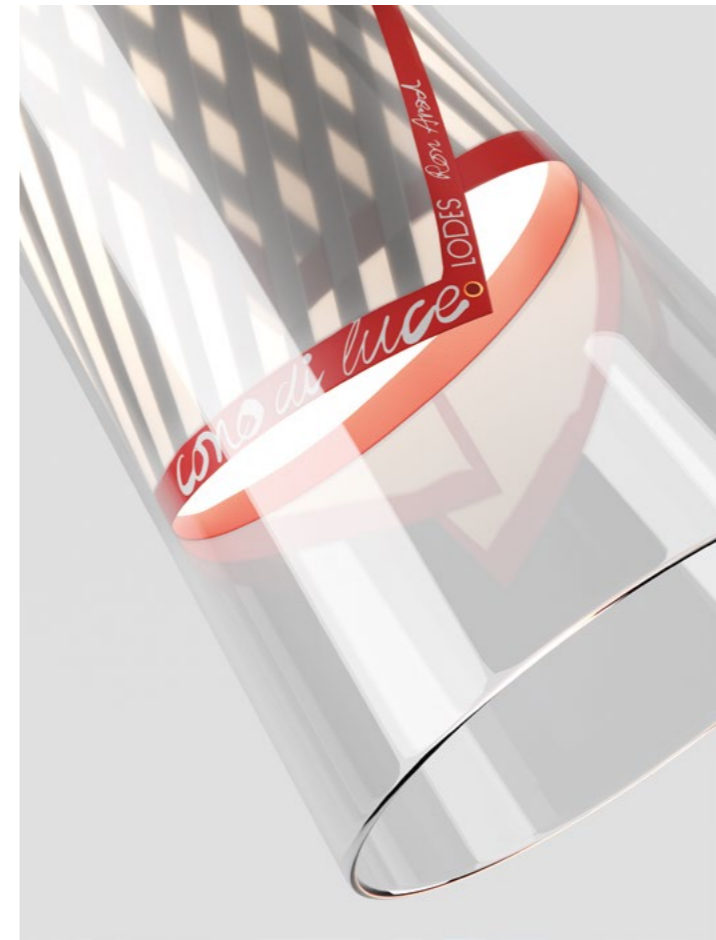

Cono di Luce small, FINISH Red.



Cono di Luce small, FINISH Grey.



Cono di Luce, table lamp, FINISH Gold.



*Cono di Luce*, objet unique en son genre, représente la synthèse du savoir-faire avant-gardiste de Lodes et de la créativité de Ron Arad. Cette lampe se caractérise par un cône en Pyrex transparent qui abrite une feuille avec une carte de circuit imprimé (PCB) et une monture, également en PCB. Un autre élément distinctif de *Cono di Luce* est le cadre qui personnalise la feuille placée à l'intérieur du cône et qui porte le nom du produit, la signature du designer et le nom de la société. La lampe, bien que fortement distinctive grâce au caractère décisif de son esthétique, s'intègre dans des contextes allant des environnements résidentiels aux espaces d'accueil publics et à ceux de la restauration. ●FR

*Cono di Luce* ist ein einzigartiges Objekt, eine Synthese aus Lodes' avantgardistischem Know-how und Ron Arads Kreativität. Es handelt sich um eine Leuchte, die sich durch einen transparenten Pyrex-Kegel auszeichnet, in dessen Innerem sich eine Leiterplatte (PCB) und ein Aufbau, ebenfalls aus PCB, befinden. Ein weiteres charakteristisches Element von *Cono di Luce* ist der Rahmen, der die im Inneren des Kegels platzierte Platte individuell gestaltet und den Produktnamen, die Unterschrift des Designers und den Firmennamen trägt. Auch wenn die Leuchte ausgesprochen charakteristisch ist, fügt sie sich dank ihrer ausgeprägten Ästhetik in Kontexte ein, die von Wohnumgebungen bis hin zu öffentlichen Räumen, Hospitality und Food & Beverage reichen. ●DE

*Cono di Luce* es un objeto único en su género, la síntesis de los conocimientos técnicos más avanzados de Lodes y la creatividad de Ron Arad. Es una lámpara que se caracteriza por un cono de Pyrex transparente que contiene una lámina con un circuito impreso (PCB) y un armazón, también de PCB. Otro elemento característico de *Cono di Luce* es el marco que personaliza la lámina situada dentro del cono y que lleva el nombre del producto, la firma del diseñador y el nombre de la empresa. La lámpara, aun siendo muy reconocible gracias a su estética de trazo decidido, es ideal para contextos que abarcan entornos residenciales, espacios públicos de hostelería e incluso de comida y bebida. ●ES

*Cono di Luce* – это уникальный в своем роде объект, синтез авангардного ноу-хау Lodes и творческого гения Рона Арада. Эта лампа характеризуется конусом из прозрачного пирекса, внутри которого размещается лист с печатной платой (PCB), и рамой, также изготовленной из PCB. Другим отличительным элементом *Cono di Luce* является обрамление, придающее индивидуальность листу, помещенному внутрь конуса; на нем нанесено название изделия, подпись дизайнера и название компании. Несмотря на ярко выраженные индивидуальные характеристики, благодаря своей решительной эстетике данная лампа легко вписывается в различные контексты, от жилых помещений до общественных, предназначенных для гостиничного и ресторанного бизнеса. ●RU

*Cono di Luce*可谓同类产品中的佼佼者,它将Lodes的尖端技术诀窍以及Ron Arad的设计创造力兼容并蓄。这款灯品的特征在于它那以透明派热克斯玻璃制成的椎体,其内部装有一张带有印刷电路板(PCB)的薄片和一个同样以PCB薄片制成的框架。*Cono di Luce*的另一个与众不同的元素便是檐口,它能使位于椎体内部的薄片做到个性化,薄片上列有产品名称、设计师签名及公司名称。这款灯品尽管特征强烈,但其线条鲜明的美感却使其无论是在住宅环境、酒店公共空间以及餐饮场所内皆可完美搭配。●ZH

## CATEGORY CLUSTER SUSPENSION LAMP

## Cono di Luce small

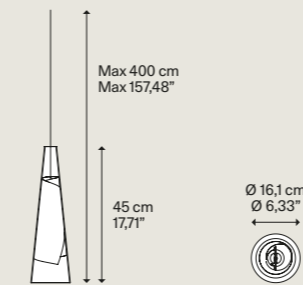

Net weight	0,73 kg	Pack	3	Energy class	Classe energetica B
Peso netto	1,61 lbs	Colli			

## DESIGN Ron Arad, 2023

Outside blown glass diffuser  
Diffusore esterno in vetro soffiato

Clear  
Trasparente

Light source  
Sorgente luminosa

LED  
2700 K  
7 W  
1307 lm  
350 mA  
CRI 90  
MacAdam 3-Step  
LED and driver included  
LED e driver inclusi

Inside PCB diffuser  
Diffusore interno in PCB

Grey  
Grigio

Gold  
Oro

Red  
Rosso

Code  
Codice

21010 3227

21010 5027

21010 6027



## Cono di Luce large

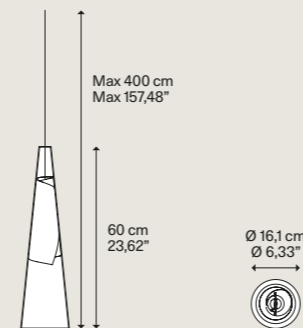

Net weight	1,12 kg	Pack	3	Energy class	Classe energetica B
Peso netto	2,47 lbs	Colli			

Outside blown glass diffuser  
Diffusore esterno in vetro soffiato

Clear  
Trasparente

Light source  
Sorgente luminosa

LED  
2700 K  
7 W  
1307 lm  
350 mA  
CRI 90  
MacAdam 3-Step  
LED and driver included  
LED e driver inclusi

Inside PCB diffuser  
Diffusore interno in PCB

Grey  
Grigio

Gold  
Oro

Red  
Rosso

Code  
Codice

21011 3227

21011 5027

21011 6027



Cluster suspension lamps must be installed on a canopy ► P. 318–327  
Le lampade a sospensione cluster devono essere installate su rosone ► P. 318–327

Cono di Luce small » Cluster suspension lamp

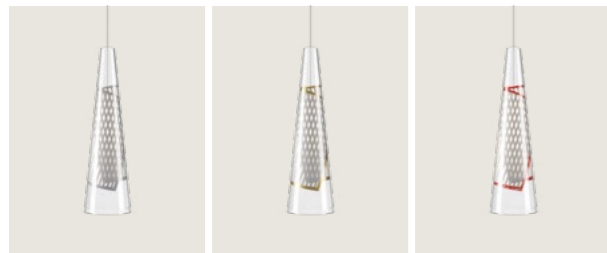

Cono di Luce large » Cluster suspension lamp

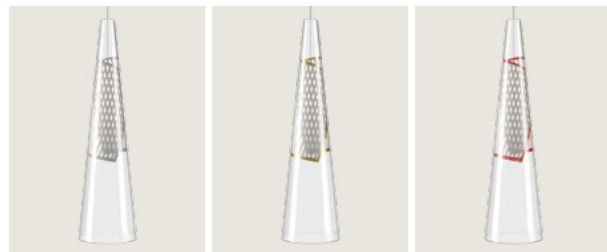

Cono di Luce » Table lamp

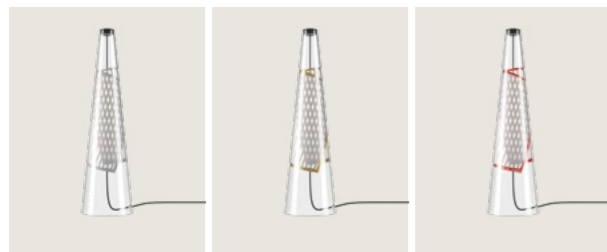

## CATEGORY TABLE LAMP

## Cono di Luce

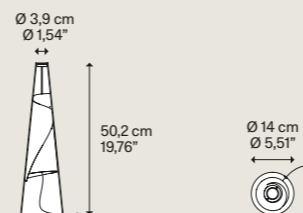

Net weight	0,91 kg	Pack	2	Energy class	Classe energetica B
Peso netto	2,00 lbs	Colli			

## DESIGN Ron Arad, 2023

Outside blown glass diffuser  
Diffusore esterno in vetro soffiato

Clear  
Trasparente

Light source  
Sorgente luminosa

LED  
2700 K  
7,5 W  
1307 lm  
5 V – 1,5 A  
CRI 90  
MacAdam 3-Step  
LED, driver and touch dimmer included  
LED, driver e touch dimmer inclusi

Inside PCB diffuser  
Diffusore interno in PCB

Grey  
Grigio

Gold  
Oro

Red  
Rosso

Code  
Codice

21080 3227

21080 5027

21080 6027





# Single canopies

## Recessed Micro Trimless

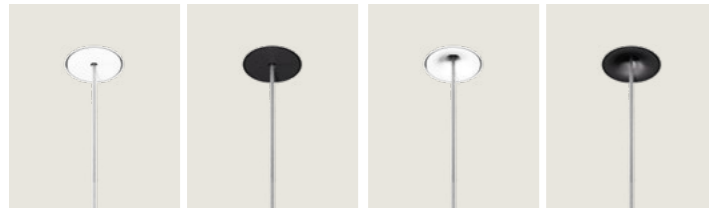

Pure trimless

Deep trimless

## Recessed Micro

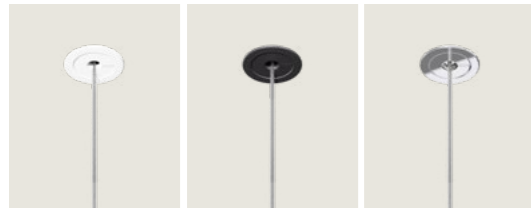

## Single Mini

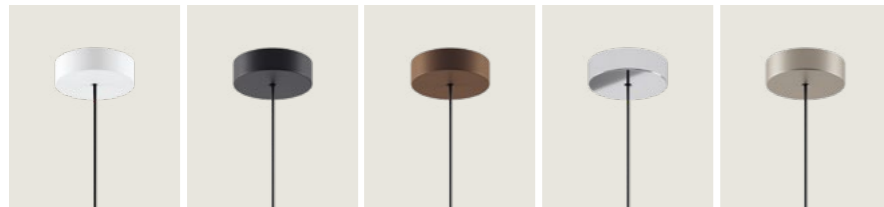

## Wall Standard

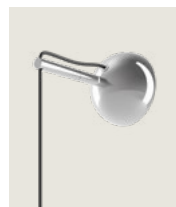

### CATEGORY RECESSED CANOPY

#### Recessed Micro

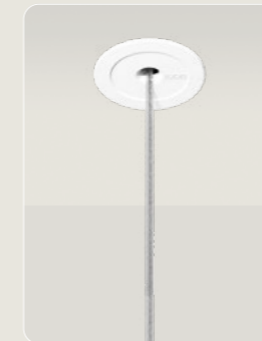
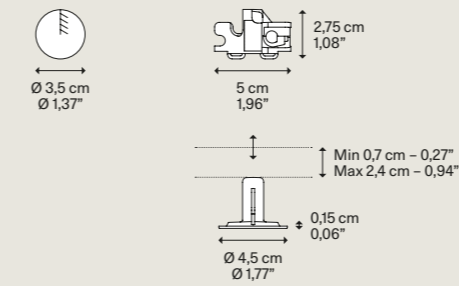

Net weight 0,015 kg / 0,033 lbs | Pack Colli 1



Description Descrizione	Methacrylate structure Struttura in metacrilato	System Sistema	Code Codice
Recessed canopy for single lamp max capacity 3,5 kg - 7,71 lbs	<ul style="list-style-type: none"> <li>Matte White - 9010 * / Bianco Opaco - 9010 *</li> <li>Matte Black - 9005 / Nero Opaco - 9005</li> </ul>	Recessed	R01L01 1000
Rosone da incasso per lampada singola portata max 3,5 kg - 7,71 lbs	<ul style="list-style-type: none"> <li>Chrome / Cromo</li> </ul>		R01L01 2000
	* Paintable with mural paint / Verniciabile con pittura murale		R01L01 4000

### CATEGORY RECESSED CANOPY

#### Recessed Micro Trimless

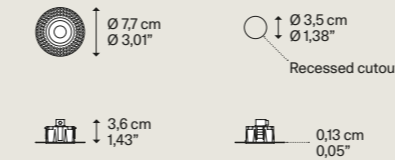

#### Recessed Micro Trimless - Pure

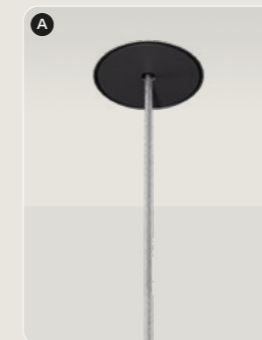

#### Recessed Micro Trimless - Deep

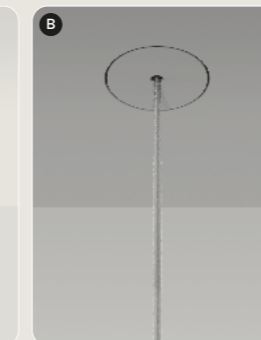

- A Recessed Micro Trimless - Not painted
- B Recessed Micro Trimless - Painted

Net weight 0,12 kg / 0,26 lbs | Pack Colli 1



Recessed Micro ▶ Suitable for ceilings up to 2,4 cm - 0,94" thickness.  
Recessed Micro Trimless ▶ Suitable for ceilings up to max 2,2 cm - 0,85" thickness.

Recessed Micro ▶ Adatta per soffitti fino a 2,4 cm - 0,94" di spessore.  
Recessed Micro Trimless ▶ Adatto per soffitti fino a max 2,2 cm - 0,85" di spessore.



## CATEGORY SINGLE CANOPY

## Single Mini

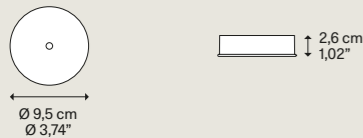

Description Descrizione	Methacrylate structure Struttura in metacrilato	System Sistema	Code Codice
Single ceiling canopy small size	Matte White - 9010* Bianco Opaco - 9010*	Single	R11L01 1000
	Matte Black - 9005 Nero Opaco - 9005		R11L01 2000
Rosone per lampada singola versione mini	Coppery Bronze Bronzo Ramato		R11L01 3500
	Chrome Cromo		R11L01 4000
	Champagne Champagne		R11L01 4500

\* Paintable with mural paint  
Verniciabile con pittura murale

Net weight 0,13 kg  
Peso netto 0,28 lbs

Pack Colli 1



## CATEGORY SINGLE CANOPY

## Single Standard

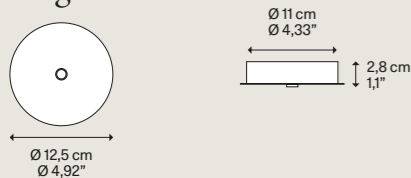

Description Descrizione	Metal structure Struttura in metallo	System Sistema	Code Codice
Single ceiling canopy standard size	Matte White - 9010 Bianco Opaco - 9010	Single	R03L01 1000
Rosone per lampada singola versione standard			

Net weight 0,40 kg  
Peso netto 0,88 lbs

Pack Colli 1



## CATEGORY WALL CANOPY

## Wall Standard

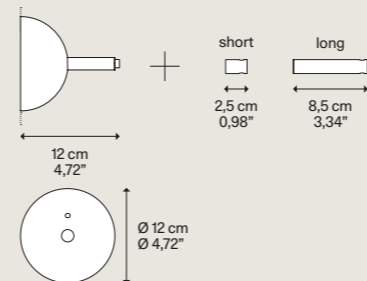

Net weight 0,40 kg  
Peso netto 0,88 lbs

Pack Colli 1

Description Descrizione	Metal structure Montatura in metallo	System Sistema	Code Codice
Wall canopy for suspension modular system	Chrome Cromo	Wall	R12L01 4000
Rosone a parete per sistema modulare a sospensione			



Wall Standard ► Both accessories in the two available lengths are supplied in the box with the wall bracket.

Wall Standard ► Entrambi gli accessori nelle due diverse lunghezze sono inclusi nella confezione con il supporto a parete.



# Multiple canopies

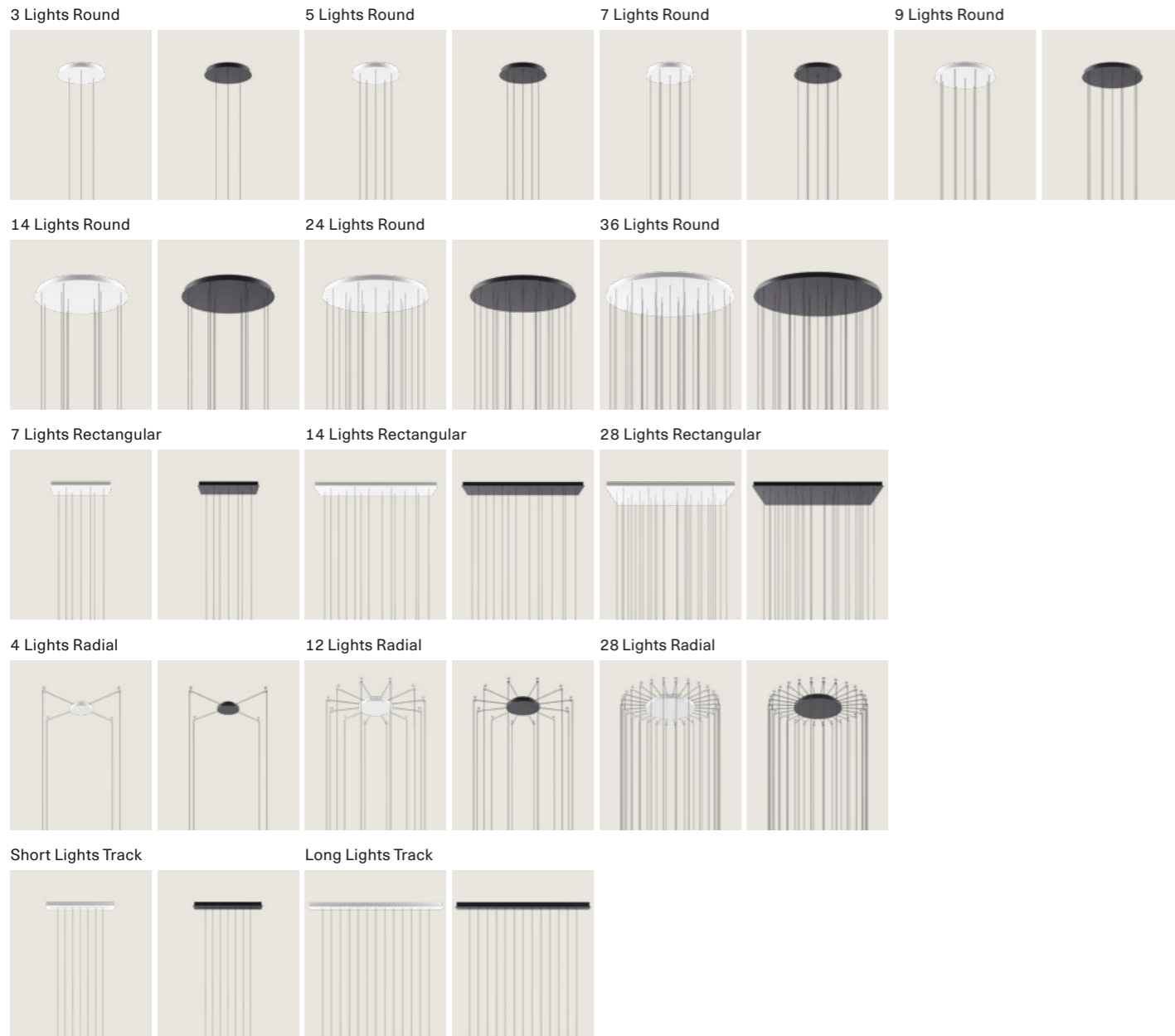

CATEGORY CLUSTER CANOPY

### 3 Lights Round

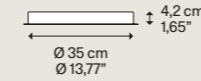
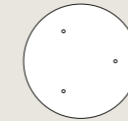

Net weight 3,55 kg / 7,82 lbs | Pack 1 | Colli 1

Description Descrizione	Metal structure Struttura in metallo	System Sistema	Code Codice
Round canopy for 3 suspensions	● Matte White - 9010 ● Bianco Opaco - 9010	Cluster	R04L03 1000
Rosone circolare per 3 sospensioni	● Matte Black - 9005 ● Nero Opaco - 9005		R04L03 2000



### 5 Lights Round

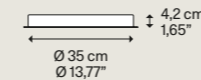
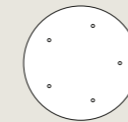

Net weight 3,55 kg / 7,82 lbs | Pack 1 | Colli 1

Description Descrizione	Metal structure Struttura in metallo	System Sistema	Code Codice
Round canopy for 5 suspensions	● Matte White - 9010 ● Bianco Opaco - 9010	Cluster	R04L05 1000
Rosone circolare per 5 sospensioni	● Matte Black - 9005 ● Nero Opaco - 9005		R04L05 2000



### 7 Lights Round

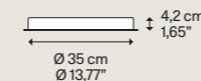
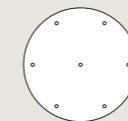

Net weight 3,55 kg / 7,82 lbs | Pack 1 | Colli 1

Description Descrizione	Metal structure Struttura in metallo	System Sistema	Code Codice
Round canopy for 7 suspensions	● Matte White - 9010 ● Bianco Opaco - 9010	Cluster	R04L07 1000
Rosone circolare per 7 sospensioni	● Matte Black - 9005 ● Nero Opaco - 9005		R04L07 2000

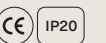

### 9 Lights Round

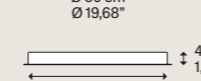

Net weight 5,84 kg / 12,87 lbs | Pack 1 | Colli 1

Description Descrizione	Metal structure Struttura in metallo	System Sistema	Code Codice
Round canopy for 9 suspensions	● Matte White - 9010 ● Bianco Opaco - 9010	Cluster	R04L09 1000
Rosone circolare per 9 sospensioni	● Matte Black - 9005 ● Nero Opaco - 9005		R04L09 2000





CATEGORY CLUSTER CANOPY

### 14 Lights Round

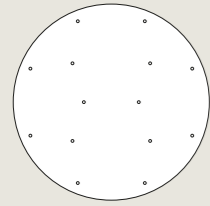

Ø 74 cm  
Ø 29,13"

4,2 cm  
1,65"

Ø 70 cm  
Ø 27,55"

Net weight 14,14 kg  
Peso netto 31,17 lbs

Pack Colli 1

CE IP20

Description Descrizione	Metal structure Struttura in metallo	System Sistema	Code Codice
Round canopy for 14 suspensions	● Matte White - 9010 Bianco Opaco - 9010	Cluster	R04L14 1000
Rosone circolare per 14 sospensioni	● Matte Black - 9005 Nero Opaco - 9005		R04L14 2000

### 24 Lights Round

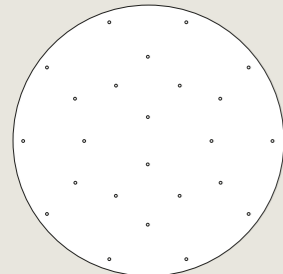

Ø 100 cm  
Ø 39,37"

4,2 cm  
1,65"

Ø 96,5 cm  
Ø 38"

Net weight 23,50 kg  
Peso netto 51,80 lbs

Pack Colli 1

CE IP20

Description Descrizione	Metal structure Struttura in metallo	System Sistema	Code Codice
Round canopy for 24 suspensions	● Matte White - 9010 Bianco Opaco - 9010	Cluster	R04L24 1000
Rosone circolare per 24 sospensioni	● Matte Black - 9005 Nero Opaco - 9005		R04L24 2000

### 36 Lights Round

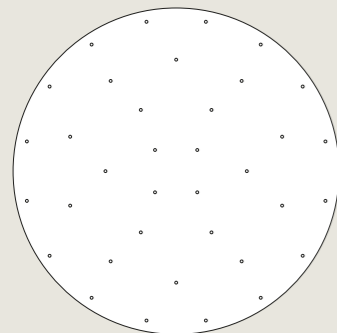

Ø 120 cm  
Ø 47,24"

4,2 cm  
1,65"

Ø 116,5 cm  
Ø 45,86"

Net weight 32,70 kg  
Peso netto 72,09 lbs

Pack Colli 1

CE IP20

Description Descrizione	Metal structure Struttura in metallo	System Sistema	Code Codice
Round canopy for 36 suspensions	● Matte White - 9010 Bianco Opaco - 9010	Cluster	R04L36 1000
Rosone circolare per 36 sospensioni	● Matte Black - 9005 Nero Opaco - 9005		R04L36 2000

CATEGORY CLUSTER CANOPY

### 7 Lights Rectangular



45 cm  
17,71"

70 cm  
27,55"

4,2 cm  
1,65"

Net weight 9,89 kg  
Peso netto 21,80 lbs

Pack Colli 1

CE IP20

Description Descrizione	Metal structure Struttura in metallo	System Sistema	Code Codice
Rectangular canopy for 7 suspensions	● Matte White - 9010 Bianco Opaco - 9010	Cluster	R05L07 1000
Rosone rettangolare per 7 sospensioni	● Matte Black - 9005 Nero Opaco - 9005		R05L07 2000

### 14 Lights Rectangular



45 cm  
17,71"

140 cm  
55,11"

4,2 cm  
1,65"

Net weight 17,10 kg  
Peso netto 37,80 lbs

Pack Colli 1

CE IP20

Description Descrizione	Metal structure Struttura in metallo	System Sistema	Code Codice
Rectangular canopy for 14 suspensions	● Matte White - 9010 Bianco Opaco - 9010	Cluster	R05L14 1000
Rosone rettangolare per 14 sospensioni	● Matte Black - 9005 Nero Opaco - 9005		R05L14 2000

### 28 Lights Rectangular

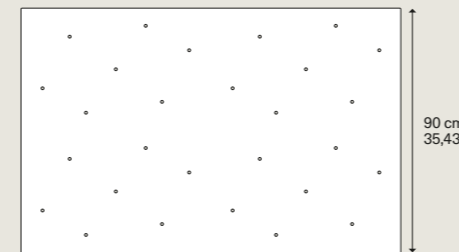

90 cm  
35,43"

140 cm  
55,11"

4,2 cm  
1,65"

Net weight 31,10 kg  
Peso netto 68,56 lbs

Pack Colli 1

CE IP20

Description Descrizione	Metal structure Struttura in metallo	System Sistema	Code Codice
Rectangular canopy for 28 suspensions	● Matte White - 9010 Bianco Opaco - 9010	Cluster	R05L28 1000
Rosone rettangolare per 28 sospensioni	● Matte Black - 9005 Nero Opaco - 9005		R05L28 2000



CATEGORY **RADIAL CANOPY**

### 4 Lights Radial



Ø 16,5 cm  
Ø 6,49"

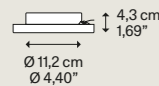

Net weight 0,35 kg  
Peso netto 0,13 lbs  
Pack Colli 1

Description Descrizione	Metal structure Struttura in metallo	System Sistema	Code Codice
Radial canopy max 4 suspension Radial Swag Kit not included	● Matte White - 9010 Bianco Opaco - 9010	Radial	<b>R10L04 1000</b>
Rosone radiale max 4 sospensioni Radial Swag Kit non incluso	● Matte Black - 9005 Nero Opaco - 9005		<b>R10L04 2000</b>

CE IP20

### 12 Lights Radial



Ø 25 cm  
Ø 9,84"

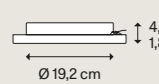

Net weight 1,05 kg  
Peso netto 2,31 lbs  
Pack Colli 1

Description Descrizione	Metal structure Struttura in metallo	System Sistema	Code Codice
Radial canopy max 12 suspension Radial Swag Kit not included	● Matte White - 9010 Bianco Opaco - 9010	Radial	<b>R10L12 1000</b>
Rosone radiale max 12 sospensioni Radial Swag Kit non incluso	● Matte Black - 9005 Nero Opaco - 9005		<b>R10L12 2000</b>

CE IP20

### 28 Lights Radial

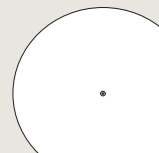

Ø 36 cm  
Ø 14,17"



Net weight 3,35 kg  
Peso netto 7,38 lbs  
Pack Colli 1

Description Descrizione	Metal structure Struttura in metallo	System Sistema	Code Codice
Radial canopy max 28 suspension Radial Swag Kit not included	● Matte White - 9010 Bianco Opaco - 9010	Radial	<b>R10L28 1000</b>
Rosone radiale max 28 sospensioni Radial Swag Kit non incluso	● Matte Black - 9005 Nero Opaco - 9005		<b>R10L28 2000</b>

CE IP20

### Swag Kit for Radial Canopy



Ø 2 cm  
Ø 0,78"



3 cm  
1,18"

Net weight 0,02 kg  
Peso netto 0,04 lbs  
Pack Colli 1

Description Descrizione	Polycarbonate structure Struttura in policarbonato	System Sistema	Code Codice
Wall and ceiling anchor for Radial System power cable / Max Ø 7 mm - 0,27" / Max capacity 5 kg - 11,02 lbs	● Clear Trasparente	Radial	<b>999A4 00</b>
Cilindro di decentramento per Sistema Radiale cavo elettrico / Max Ø 7 mm - 0,27" / Portata max 5 kg - 11,02 lbs			

CE

CATEGORY **TRACK CANOPY**

### Short Lights Track

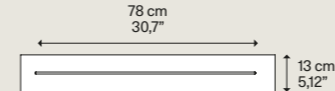

78 cm  
30,7"

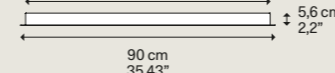

87 cm  
34,25"

Net weight 7,33 kg  
Peso netto 16,16 lbs  
Pack Colli 1

Description Descrizione	Metal structure Struttura in metallo	System Sistema	Code Codice
Multiple linear track standard version max 7 suspensions	● Matte White - 9010 Bianco Opaco - 9010	Track	<b>R08L07 1000</b>
Binario lineare multiplo versione standard max 7 sospensioni	● Matte Black - 9005 Nero Opaco - 9005		<b>R08L07 2000</b>

CE IP20

### Long Lights Track

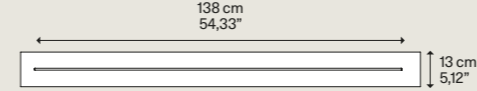

138 cm  
54,33"

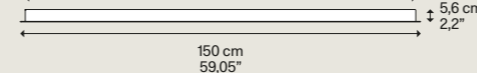

147 cm  
57,87"

Net weight 11,85 kg  
Peso netto 26,12 lbs  
Pack Colli 1

Description Descrizione	Metal structure Struttura in metallo	System Sistema	Code Codice
Multiple linear track standard version max 11 suspensions	● Matte White - 9010 Bianco Opaco - 9010	Track	<b>R08L11 1000</b>
Binario lineare multiplo versione standard max 11 sospensioni	● Matte Black - 9005 Nero Opaco - 9005		<b>R08L11 2000</b>

CE IP20

Suspension aligned, maximum quantity  
Sospensione allineata, quantità massima



Staggered suspension, maximum quantity  
Sospensione sfalsata, quantità massima



Short Lights Track		Long Lights Track		Short Lights Track		Long Lights Track	
Max 7	A-Tube	Max 11	A-Tube	Max 7	A-Tube	Max 11	A-Tube
Max 6	A-Tube Nano	Max 10	A-Tube Nano	Max 6	A-Tube Nano	Max 10	A-Tube Nano
Max 6	A-Tube Nano Duo	Max 10	A-Tube Nano Duo	Max 6	A-Tube Nano Duo	Max 10	A-Tube Nano Duo
Max 4	Cono di Luce small	Max 8	Cono di Luce small	Max 7	Cono di Luce small	Max 11	Cono di Luce small
Max 4	Cono di Luce large	Max 8	Cono di Luce large	Max 7	Cono di Luce large	Max 11	Cono di Luce large
Max 6	IVY I	Max 10	IVY I	Max 7	IVY I	Max 11	IVY I
Max 5	Jefferson	Max 8	Jefferson	Max 6	Jefferson	Max 10	Jefferson
Max 4	JIM cylinder	Max 8	JIM cylinder	Max 7	JIM cylinder	Max 11	JIM cylinder
Max 3	JIM cone	Max 5	JIM cone	Max 5	JIM cone	Max 9	JIM cone
Max 3	JIM bell	Max 5	JIM bell	Max 5	JIM bell	Max 9	JIM bell
Max 4	Kelly Cluster	Max 8	Kelly Cluster	Max 7	Kelly Cluster	Max 11	Kelly Cluster
Max 7	Nostalgia small	Max 11	Nostalgia small	Max 7	Nostalgia small	Max 11	Nostalgia small
Max 4	Nostalgia medium	Max 7	Nostalgia medium	Max 7	Nostalgia medium	Max 11	Nostalgia medium
Max 3	Nostalgia large	Max 5	Nostalgia large	Max 5	Nostalgia large	Max 9	Nostalgia large
Max 4	Oblò small	Max 7	Oblò small	Max 7	Oblò small	Max 13	Oblò small
Max 4	Oblò medium	Max 7	Oblò medium	Max 7	Oblò medium	Max 12	Oblò medium
Max 4	Oblò large	Max 6	Oblò large	Max 6	Oblò large	Max 11	Oblò large
Max 7	Rain	Max 11	Rain	Max 7	Rain	Max 11	Rain
Max 3	Random	Max 5	Random	Max 5	Random	Max 9	Random
Max 7	Random Solo 10	Max 11	Random Solo 10	Max 7	Random Solo 10	Max 11	Random Solo 10
Max 7	Random Solo 12	Max 11	Random Solo 12	Max 7	Random Solo 12	Max 11	Random Solo 12
Max 6	Random Solo 14	Max 10	Random Solo 14	Max 7	Random Solo 14	Max 11	Random Solo 14
Max 4	Random Solo 18	Max 8	Random Solo 18	Max 7	Random Solo 18	Max 11	Random Solo 18
Max 4	Random Solo 23	Max 6	Random Solo 23	Max 7	Random Solo 23	Max 11	Random Solo 23
Max 3	Random Solo 28	Max 6	Random Solo 28	Max 6	Random Solo 28	Max 10	Random Solo 28
Max 7	Spider	Max 11	Spider	Max 7	Spider	Max 11	Spider
Max 6	Volum 14	Max 10	Volum 14	Max 7	Volum 14	Max 11	Volum 14
Max 4	Volum 22	Max 7	Volum 22	Max 7	Volum 22	Max 11	Volum 22
Max 3	Volum 29	Max 5	Volum 29	Max 5	Volum 29	Max 9	Volum 29



## Out of Scale

“*Out of Scale*” elevates the concept of “*Standard Bespoke*” to the pinnacle of customisation and freedom of expression. Light compositions become bespoke solutions for any space: thanks to the flexibility offered by the combinations of lamps and canopies, the possibilities are endless, and the solutions are entirely personalised. By developing unprecedented configurations of shapes and sizes, *Lodes* can meet the needs of any space and creative project, furnishing environments with a luminous scenography capable of making a significant impact.

“*Out of Scale*” eleva il concetto di “*Standard Bespoke*” alla massima personalizzazione e libertà espressiva. Le composizioni di luce diventano risposte su misura per qualsiasi spazio: grazie alla flessibilità offerta dalle combinazioni tra lampade e rosoni, le applicazioni diventano infinite e le soluzioni completamente personalizzate. Sviluppando inedite configurazioni di forme e dimensioni, *Lodes* può soddisfare le esigenze di qualsiasi spazio e progetto creativo per arredare ogni ambiente con una scenografia luminosa in grado di fare la differenza.

# Out of Scale

# Endless applications



Lodes can design a personalised solution for any type of environment, regardless of its size or complexity, to propose unique systems that enhance the architectural forms of the space and meet the specific requirements of each customer.

Lodes può progettare la soluzione su misura per ogni tipo di ambiente, indipendentemente dalle sue dimensioni o dalla sua complessità, per proporre sistemi personalizzati in grado di valorizzare le forme architettoniche dello spazio e di rispondere alle richieste specifiche di ciascun cliente.

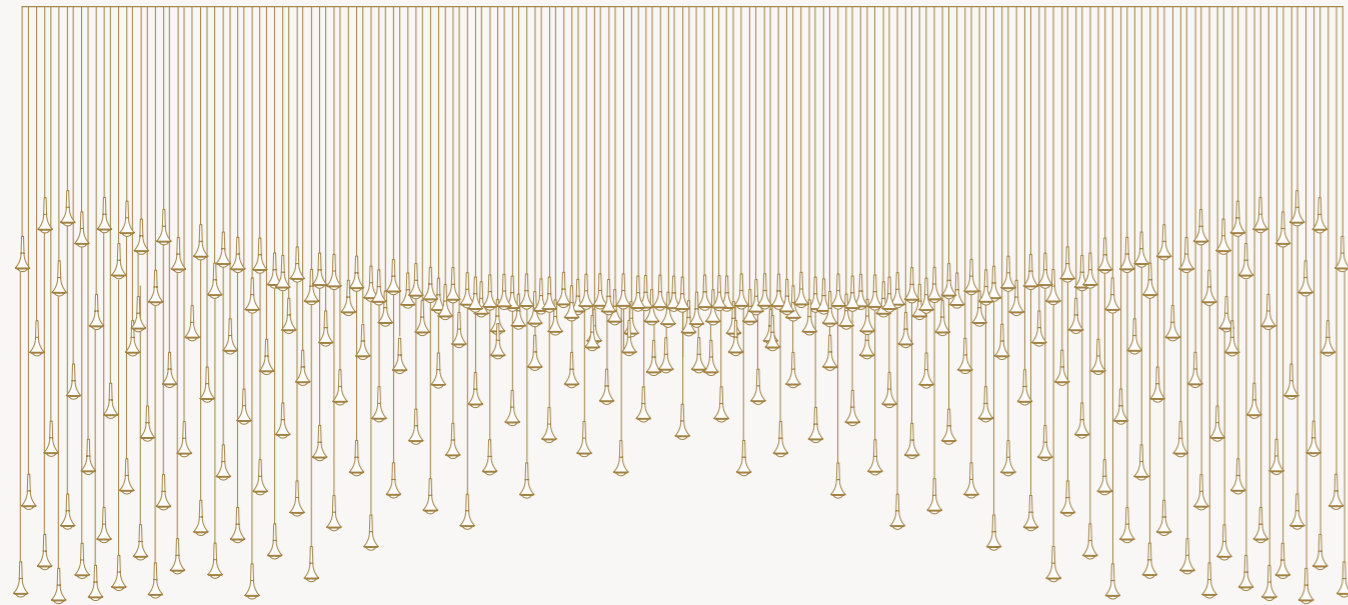

Product  
Rain

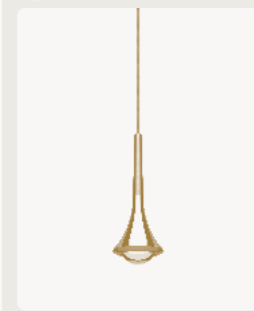

Request  
Composition in an entrance area

Arrangement  
Wave effect

Type of canopy  
Recessed Micro

Quantity of lamps	Composition height
250-300 pcs	6,5 m

## The Fullerton Ocean Park Hotel—Hong Kong

Product  
Random Solo

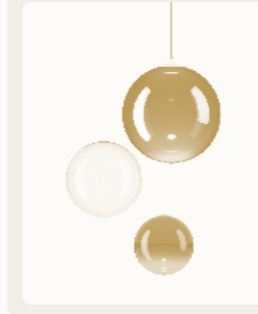

INTERIOR DESIGNER: EM BESPOKE – PH: ALEX LEUNG

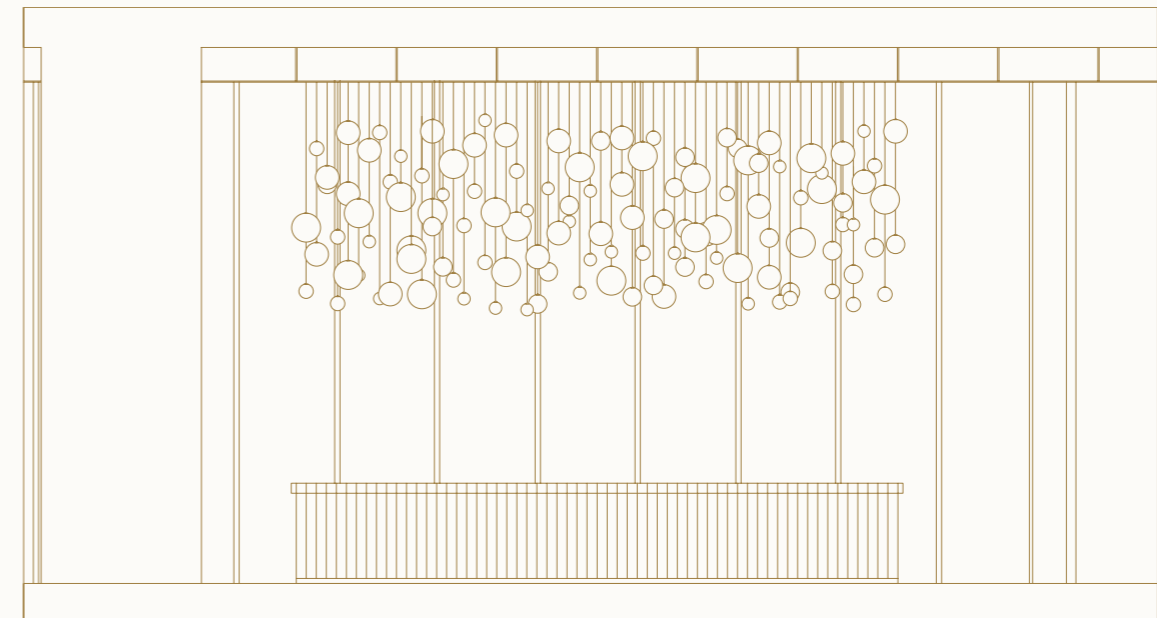

Request  
Composition in a hotel lobby

Arrangement  
Staggered

Type of canopy  
Recessed Micro

Quantity of lamps	Composition height	Height of lower lamp
120 pcs	5 m	2,7 m



# Penn State Health, Hampden Medical Center—Enola, Pennsylvania, USA

Product  
A-Tube Nano



Request  
Composition in a medical center

---

Arrangement  
Golden rule spiral

---

Type of canopy  
Recessed Micro

---

Quantity of lamps  
135 pcs

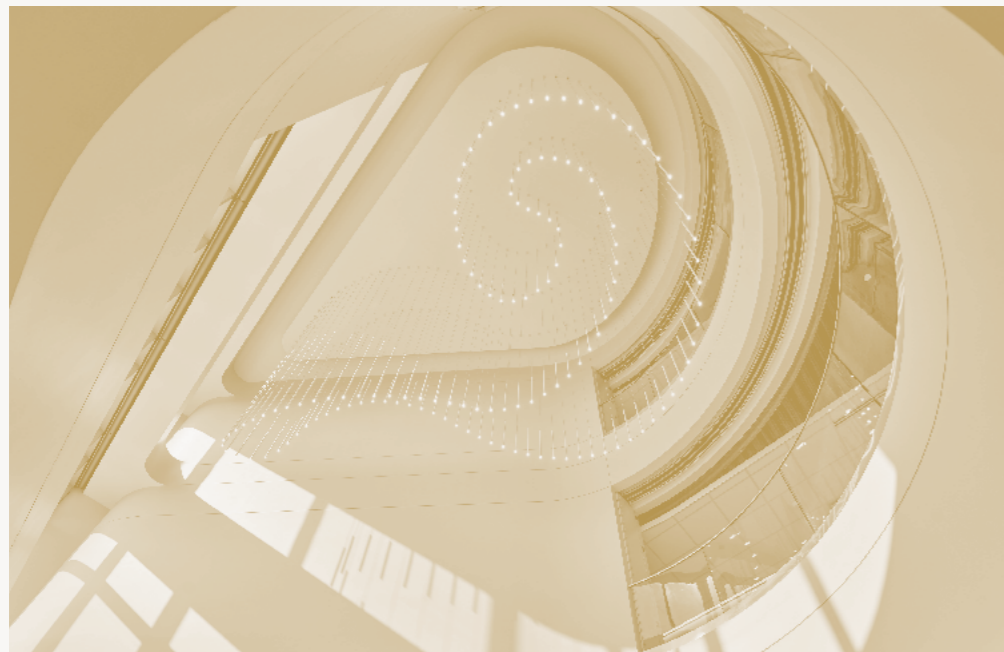
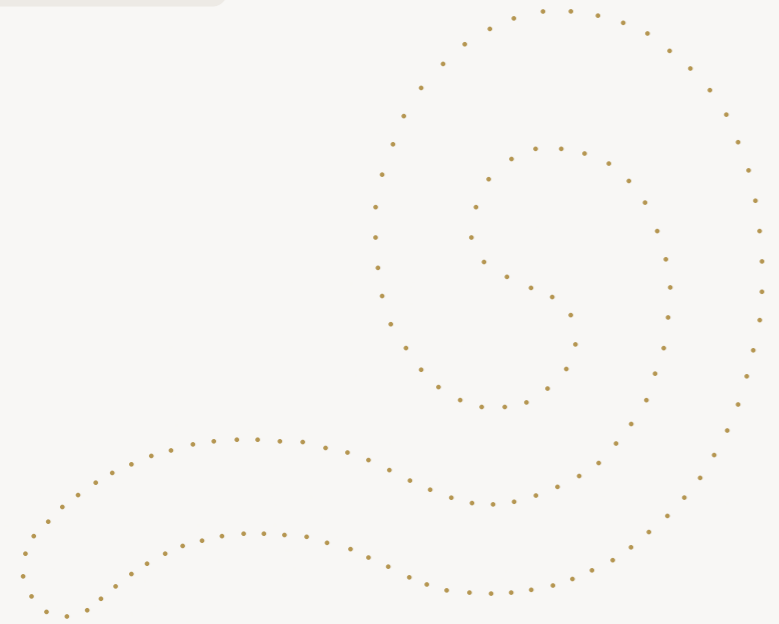

PROJECT BY: CANNONDESIGN, INC. – PH: TODD MASON©HALKIN MASON PHOTOGRAPHY

Product  
Random Solo



Request  
Composition in the lobby

---

Arrangement  
Staggered

---

Type of canopy  
Recessed Micro

---

Quantity of lamps  
370 pcs

---

Composition height	Distance from the floor – height of lower lamp
24 m	8 m





Unprecedented configurations in terms of shape and size come to life in *Lodes*, where interior designers craft tailor-made lighting projects based on the environment and the client's preferences.

Configurazioni inedite per forma e dimensione prendono vita in *Lodes*, dove gli interior designer studiano progetti di luce su misura a seconda dell'ambiente e dei desideri del committente.

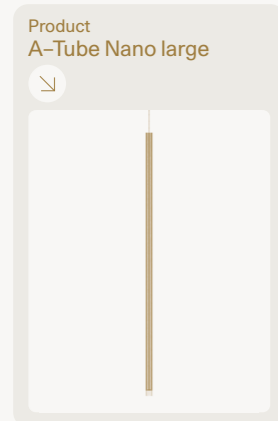
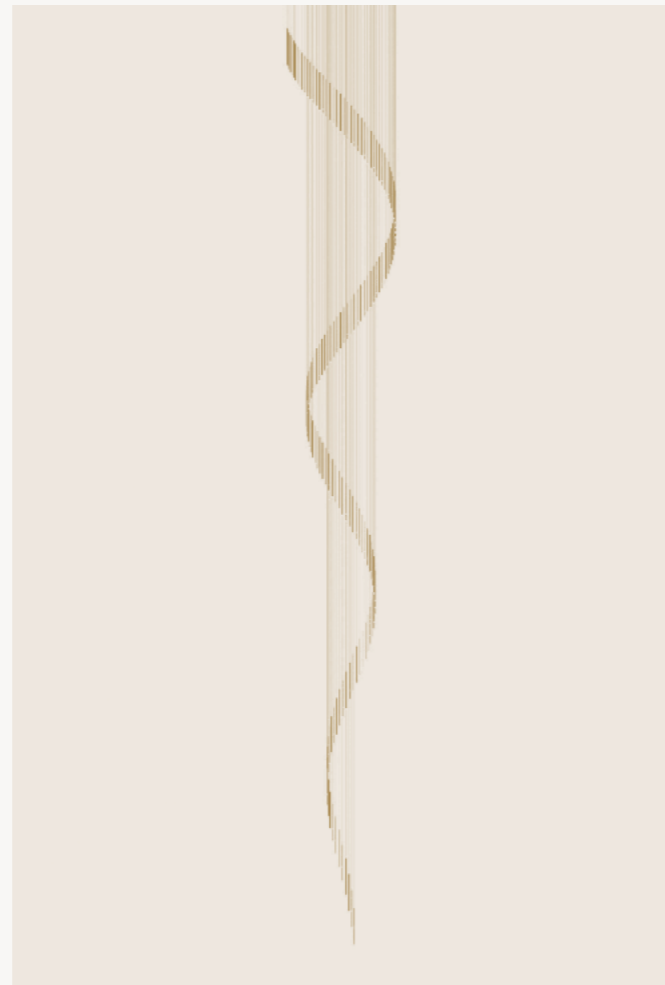
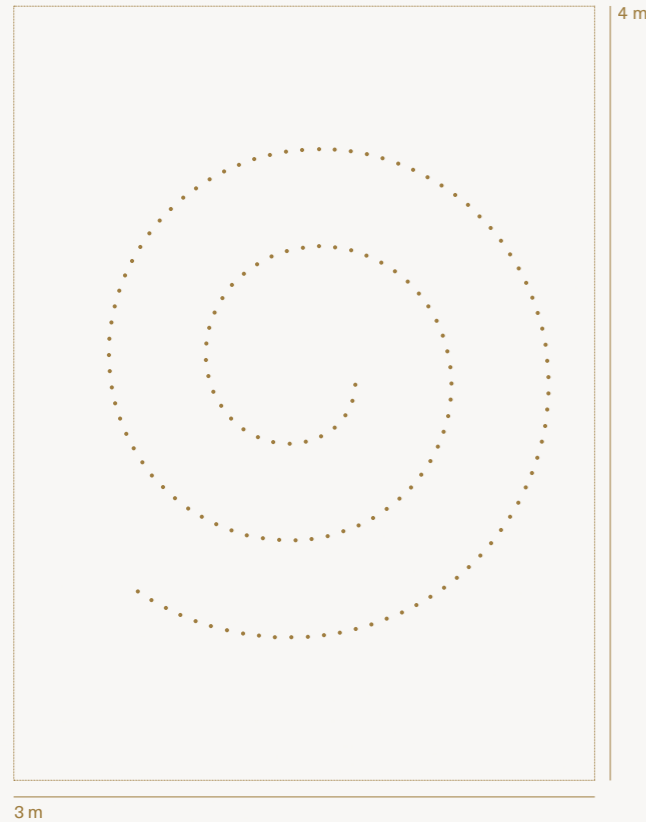

Request Composition in an entrance area		
Arrangement Spiral		
Type of canopy Recessed Micro		
Quantity of lamps	Composition height	Distance from the floor - height of lower lamp
150 pcs	24 m	8 m



Request Composition in an entrance area/stairwell		
Arrangement Clustered		
Type of canopy Recessed Micro		
Quantity of lamps	Composition height	Height of lower lamp
60 pcs	7,7 m	3,4 m

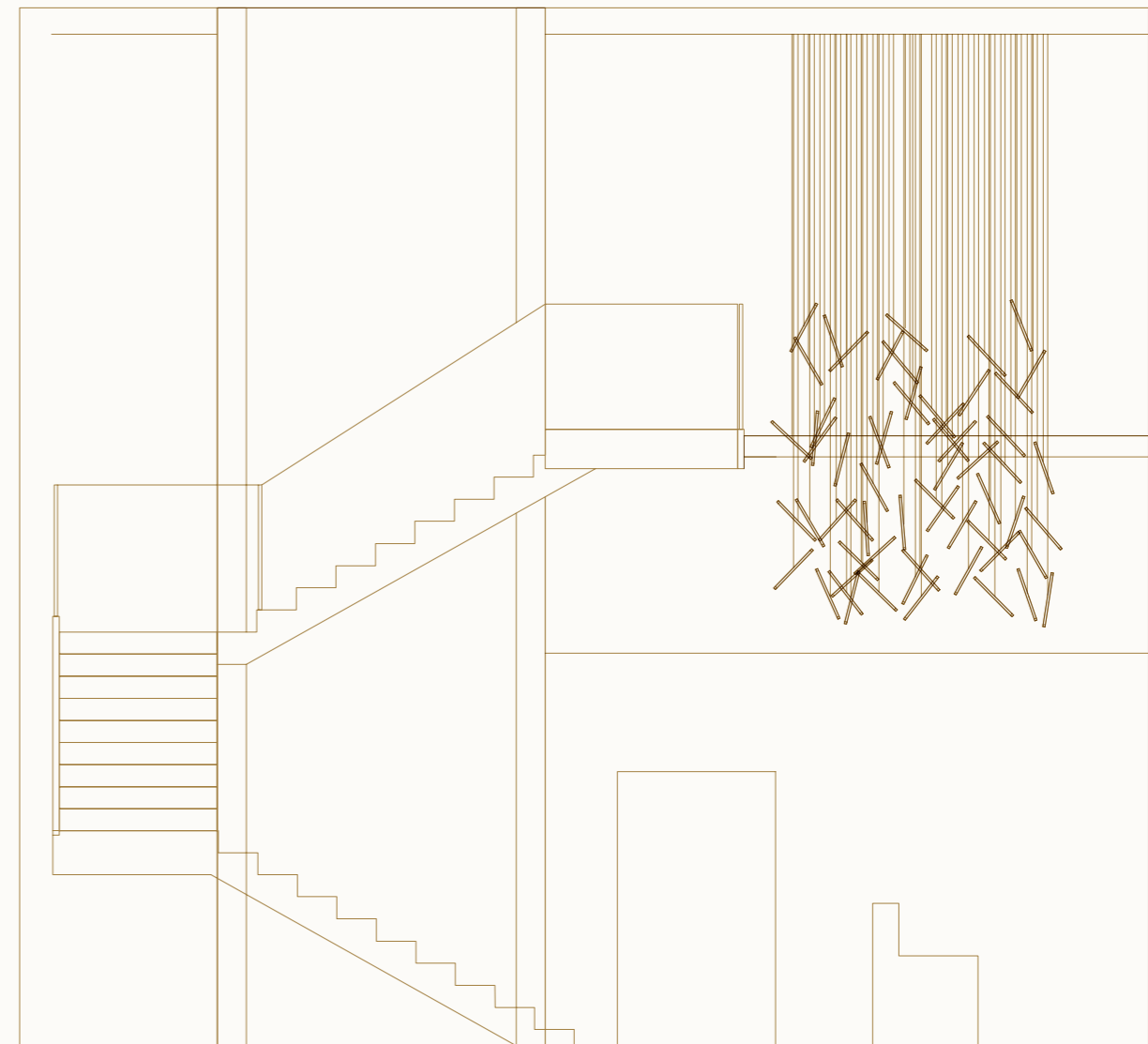
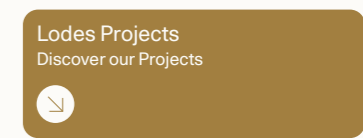

Contact us to request your customised solution.  
Contattaci per richiedere la tua soluzione personalizzata.



# Endless applications

Out of Scale  
View the video



# One output



# Tidal

Designed by Needs Studio



Year 2023, 2024, 2025

*Tidal* is an elegant collection of lamps with exceptional luminous efficiency. Its fluid, impactful design, inspired by the movements of celestial bodies and tides, creates a dynamic visual experience – appearing differently from various viewing angles thanks to the ring’s irregular, asymmetrical shape, with one side wider than the other. *Tidal* emits light both downward and upward, with all technical elements concealed within the compact, slim lamp body, highlighting its aesthetic appeal. Initially conceived as a ceiling lamp, *Tidal* is now also available as a suspension lamp in multiple sizes – a 45, 60, and 75 cm for ceiling versions, and 60 cm for suspension versions – and in four versatile matte finishes, allowing it to illuminate and enhance any environment. It can be used solo or in compositions, playing with the collection’s various functions and sizes. The new stand-alone suspension option is perfect for lighting tables, including larger ones, in both residential and Food & Beverage settings.

*Tidal* è un’elegante famiglia di lampade dall’eccezionale efficienza luminosa. Un design fluido e di forte impatto, ispirato ai movimenti dei corpi celesti e delle maree, fa apparire le lampade diverse a seconda di come si osservano dal basso grazie alla forma asimmetrica irregolare dell’anello, con un lato più largo dell’altro. *Tidal* proietta la luce contemporaneamente verso il basso e verso l’alto nascondendo tutti gli elementi tecnici all’interno del corpo lampada, compatto e di spessore limitato per enfatizzarne il valore estetico. Nasce come lampada da soffitto, ma ora è disponibile anche a sospensione: diverse misure – 45, 60 e 75 cm da soffitto e 60 cm per la sospensione – e quattro versatili finiture opache permettono di illuminare e decorare qualsiasi tipo di ambiente, da sole o in composizione giocando con le diverse funzioni e dimensioni della collezione. La nuova sospensione stand-alone si presta a illuminare tavoli, anche di dimensioni importanti, sia in contesti Food & Beverage che in ambito residenziale.

Go to the technical info 

Click to discover more 

Tidal COD. 199	CATEGORY LAMP		TYPE OF LIGHT	
	Suspension Ceiling	Sospensione Soffitto	Symmetrical diffused light	Luce simmetrica diffusa
				

NEW



Tidal suspension lamp and Tidal 60 ceiling lamp, FINISH Matte Champagne.









Tidal adjustable suspension, FINISH Terra.

In the suspension version, *Tidal* is available in two variants: suspension and *adjustable suspension*. The *adjustable suspension* version allows the length of the suspension cable to be adjusted up to 1,5 m from the ceiling, by lifting or lowering the body of the lamp, by grasping it with two hands, to position it at the desired height. This variant, allows you to play freely with the light, meeting the needs of a room, even changing the atmosphere without having to change the position of the product.



Nella versione a sospensione, *Tidal* è disponibile in due varianti: a *sospensione* e a *sospensione con saliscendi*. La versione con *saliscendi* permette di regolare la lunghezza del cavo di sospensione fino a 1,5 m dal soffitto, sollevando o tirando il corpo della lampada, semplicemente afferrandolo con le due mani, per posizionarlo all'altezza desiderata. Questa variante, permette di giocare liberamente con la luce, assecondando le necessità di un ambiente, cambiandone anche l'atmosfera senza dover modificare la posizione del prodotto.



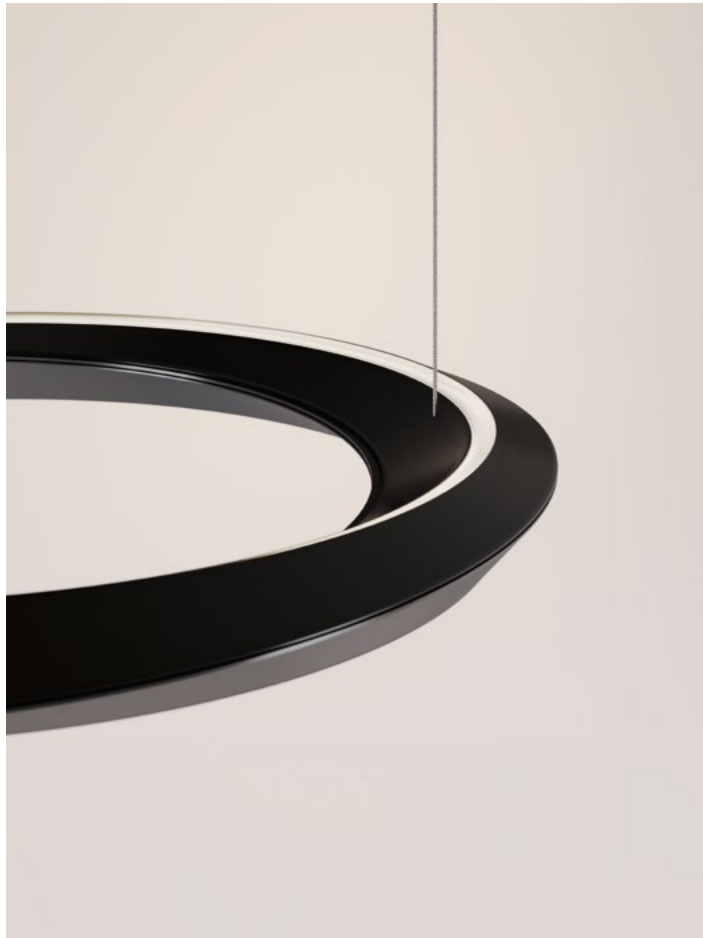

Tidal, FINISH Matte Black.



Tidal adjustable suspension, FINISH Matte White.



Tidal, FINISH Terra.





338 Tidal 45, 60 and 75, FINISHES Matte Black, Matte Champagne, Terra and Matte White.



Tidal 60, FINISH Matte White.









Tidal 60, FINISH Matte Champagne.



Tidal, FINISH Terra.







Tidal 60, FINISH Matte White.

*Tidal* est une élégante famille de lampes dont l'efficacité lumineuse du rayonnement est exceptionnelle. Un design fluide et impactant qui s'inspire des mouvements des corps célestes et des marées, pour donner aux lampes un aspect différent selon le point d'observation par le bas grâce à la forme asymétrique de l'anneau, avec un côté plus large que l'autre. *Tidal* projette la lumière simultanément vers le bas et vers le haut, dissimulant tous les éléments techniques dans le corps de la lampe, compact et d'épaisseur limitée pour souligner sa valeur esthétique. Créée comme plafonnier, la lampe est désormais disponible en suspension : plusieurs tailles – 45, 60 et 75 cm pour le plafonnier et 60 cm pour la suspension – en outre, quatre finitions mates polyvalentes permettent d'éclairer et de décorer tout type d'environnement, seules ou en composition en jouant avec les différentes fonctions et tailles de la collection. La nouvelle suspension stand-alone est idéale pour l'éclairage de tables, même de grande taille, aussi bien dans les contextes Food & Beverage que dans les complexes résidentiels. ● FR

*Tidal* ist eine elegante Leuchtenfamilie mit außergewöhnlicher Leuchteffizienz. Ein fließendes effektvolles Design, inspiriert von den Bewegungen der Himmelskörper und der Gezeiten, lässt die Leuchte dank der unregelmäßigen, asymmetrischen Form des Rings, dessen eine Seite breiter als die andere ist, je nach Blickwinkel von unten anders wirken. *Tidal* projiziert das Licht gleichzeitig nach unten und nach oben und verbirgt alle technischen Elemente im Inneren des Leuchtenkörpers, der kompakt und von geringer Dicke ist, um seinen ästhetischen Wert zu unterstreichen. Ursprünglich als Deckenleuchte konzipiert, ist sie nun auch als Hängeleuchte erhältlich: Unterschiedliche Größen – 45, 60 und 75 cm in der Deckenversion und 60 cm für die Hängeversion – sowie vier vielseitige matte Ausführungen ermöglichen es, jede Art von Ambiente, einzeln oder in Kompositionen, die mit den verschiedenen Funktionen und Abmessungen der Kollektion spielen, zu erhellen und zu dekorieren. Die neue Stand-Along Hängeleuchte eignet sich für die Beleuchtung von Tischen, auch größerer Dimensionen, sowohl im Food & Beverage als auch im Wohnbereich. ● DE

*Tidal* es una elegante familia de lámparas con un rendimiento luminoso excepcional. Un diseño fluido y de gran impacto, inspirado en los movimientos de los cuerpos celestes y las mareas, hace que las lámparas parezcan diferentes según se miren desde abajo gracias a la forma asimétrica irregular del anillo, con un lado más ancho que el otro. *Tidal* proyecta la luz hacia abajo y hacia arriba al mismo tiempo, ocultando todos los elementos técnicos dentro del cuerpo de la lámpara, que es compacto y de grosor limitado para acentuar el valor estético. Nace como una lámpara de techo, pero ahora también está disponible como lámpara de suspensión: distintas medidas – 45, 60 y 75 cm de techo y 60 cm de suspensión – y cuatro versátiles acabados mate permiten iluminar y decorar cualquier tipo de ambiente, por sí solas o en composiciones jugando con las distintas funciones y tamaños de la colección. La nueva suspensión stand-alone se presta a la iluminación de mesas, incluso de gran tamaño, tanto en contextos de alimentación y bebidas como en ámbito residencial. ● ES

*Tidal* – это элегантное семейство светильников с прекрасной светоотдачей. Текучий и впечатляющий дизайн, вдохновленный движениями небесных тел и приливами, позволяет светильникам выглядеть всегда по-разному, в зависимости от того, откуда на них смотрят снизу, благодаря неправильной асимметричной форме кольца, одна сторона которого шире другой. *Tidal* проецирует свет одновременно вниз и вверх. Все технические элементы скрыты внутри корпуса лампы, компактного и небольшой толщины, что дополнительно подчеркивает ее эстетическую значимость. Возникший как потолочный светильник, теперь он доступен и в виде подвесного варианта: разные размеры – 45, 60 и 75 см для потолочной версии и 60 см для подвесной версии – и четыре универсальных матовых покрытия позволяют осветить и украсить любой тип помещения, по отдельности или в составе композиции, играя с различными функциями и размерами коллекции. Новая отдельно расположенная подвесная лампа подходит для освещения столов, в том числе большого размера, как в учреждениях общепита, так и в жилых помещениях. ● RU

*Tidal* 是一个优雅的灯具系列,具有卓越的发光效率。受天体运动和潮汐运动启发,其设计流畅且具有强烈冲击力,得益于环形那不甚规则的不对称形状,一侧较另一侧更宽,根据您从下方观察的方式,灯件看起来会有所不同。*Tidal*向下和向上同时投射光线,还将所有的技术元素隐藏在灯体内部,紧凑和有限的厚度彰显其装饰价值。初期是作为吸顶灯而诞生的,如今也提供吊灯版本:吸顶灯具有45、60和75厘米这几种不同尺寸,吊灯则提供60厘米的尺寸。四种百搭哑光饰面使其能够照亮并装饰任何环境类型,可单独置放或与该系列的不同功能与尺寸组合搭配。全新独立式吊灯可用于照明桌子,甚至是大型桌子,无论是在餐饮环境中还是在住宅范围内皆适用。● ZH



Tidal 60, FINISH Matte Champagne.



Tidal ↗ Suspension lamp **NEW LAMP**



Tidal ↗ Canopy



Tidal 45 ↗ Ceiling lamp **NEW LAMP**



Tidal 60 ↗ Ceiling lamp



Tidal 75 ↗ Ceiling lamp **NEW LAMP**



CATEGORY **SUSPENSION LAMP** **NEW LAMP**

Tidal

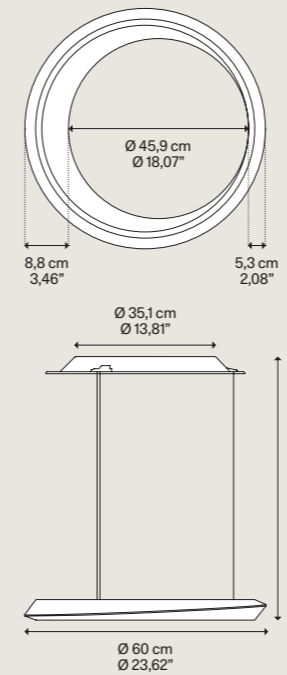

**Light source**  
Sorgente luminosa **A**

LED  
2700 K  
33 W  
6120 lm  
350+350 mA  
CRI 90  
MacAdam 3-Step

LED and driver included  
LED e driver inclusi

Double switch  
Doppia accensione

**Light source**  
Sorgente luminosa **B**

LED  
3000 K  
33 W  
6630 lm  
350+350 mA  
CRI 90  
MacAdam 3-Step

LED and driver included  
LED e driver inclusi

Double switch  
Doppia accensione

Pack Colli 2 Energy class Classe energetica C

DESIGN Needs Studio, 2025

**SUSPENSION**

Create the product code  
Crea il codice prodotto

Complete the missing piece ( ) by adding the number that identifies the canopy color and the type of dimming.

Metal structure Montatura in metallo	Code Codice	A	Code Codice	B
Matte White - 9010 Bianco Opaco - 9010	1992	1027	1992	1030
Matte Black - 9005 Nero Opaco - 9005	1992	2027	1992	2030
Extra Matte Champagne Champagne Extra Opaco	1992	4527	1992	4530
Terra Terra	1992	6727	1992	6730

**Round canopy**  
Rosone rotondo

Matte White - 9010 Bianco Opaco - 9010	1
Matte Black - 9005 Nero Opaco - 9005	2
Matte White - 9010 Bianco Opaco - 9010	5
Matte Black - 9005 Nero Opaco - 9005	6

**Type of dimming**  
Tipo di dimmerazione

Type of dimming Tipo di dimmerazione	Complete code Completa codice
TRIAC	1
TRIAC	2
DALI	5
DALI	6

**ADJUSTABLE SUSPENSION**

Create the product code  
Crea il codice prodotto

Complete the missing piece ( ) by adding the number that identifies the canopy color and the type of dimming.

Metal structure Montatura in metallo	Code Codice	A	Code Codice	B
Matte White - 9010 Bianco Opaco - 9010	1992	1027	1992	1030
Matte Black - 9005 Nero Opaco - 9005	1992	2027	1992	2030
Extra Matte Champagne Champagne Extra Opaco	1992	4527	1992	4530
Terra Terra	1992	6727	1992	6730

**Round canopy**  
Rosone rotondo

Matte White - 9010 Bianco Opaco - 9010	3
Matte Black - 9005 Nero Opaco - 9005	4
Matte White - 9010 Bianco Opaco - 9010	7
Matte Black - 9005 Nero Opaco - 9005	8

**Type of dimming**  
Tipo di dimmerazione

Type of dimming Tipo di dimmerazione	Complete code Completa codice
TRIAC	3
TRIAC	4
DALI	7
DALI	8

CE IP20 TRIAC DALI 220-240V EAC

**SUSPENSION** **ADJUSTABLE SUSPENSION**

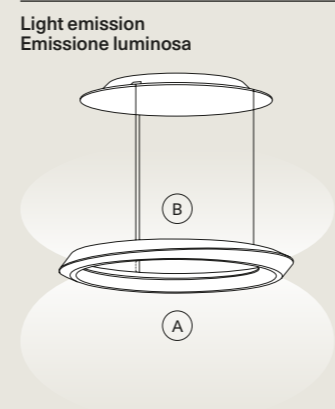

	Tidal	
<b>A</b> Direct light emission Emissione di luce diretta	2700 K	3060 lm
	3000 K	3315 lm
<b>B</b> Indirect light emission Emissione di luce indiretta	2700 K	3060 lm
	3000 K	3315 lm

**ADJUSTABLE SUSPENSION**





CATEGORY **CEILING LAMP** **NEW LAMP**

### Tidal 45

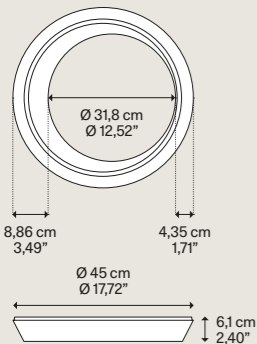

DESIGN Needs Studio, 2024

Metal structure Montatura in metallo	Code Codice <b>A</b>	Code Codice <b>B</b>
Matte White - 9010 Bianco Opaco - 9010	19931 1027	19931 1030
Matte Black - 9005 Nero Opaco - 9005	19931 2027	19931 2030
Extra Matte Champagne Champagne Extra Opaco	19931 4527	19931 4530
Terra Terra	19931 6727	19931 6730

**Light source**  
Sorgente luminosa **A**

LED  
2700 K  
27 W  
5040 lm  
1100 mA  
CRI 90  
MacAdam 3-Step

LED and driver included  
LED e driver inclusi

**Light source**  
Sorgente luminosa **B**

LED  
3000 K  
27 W  
5292 lm  
1100 mA  
CRI 90  
MacAdam 3-Step

LED and driver included  
LED e driver inclusi

Net weight Peso netto	2,80 kg 6,17 lbs	Pack Colli	1	Energy class Classe energetica	C
--------------------------	---------------------	---------------	---	-----------------------------------	---

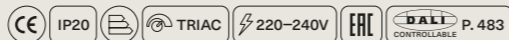

CATEGORY **CEILING LAMP**

### Tidal 60

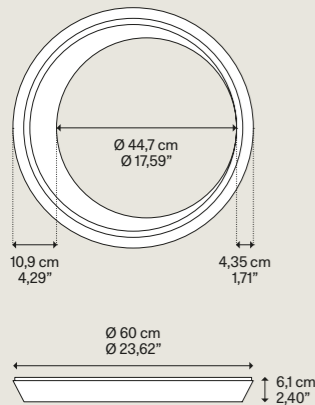

DESIGN Needs Studio, 2023

Metal structure Montatura in metallo	Code Codice <b>A</b>	Code Codice <b>B</b>
Matte White - 9010 Bianco Opaco - 9010	19933 1027	19933 1030
Matte Black - 9005 Nero Opaco - 9005	19933 2027	19933 2030
Extra Matte Champagne Champagne Extra Opaco	19933 4527	19933 4530
Terra Terra	19933 6727	19933 6730

**Light source**  
Sorgente luminosa **A**

LED  
2700 K  
37 W  
6975 lm  
Direct light > 600 mA  
Indirect light > 350 mA  
CRI 90  
MacAdam 3-Step

LED and driver included  
LED e driver inclusi

Double switch  
Doppia accensione

The driver, included, is supplied with an output voltage of 600 mA but can be adjusted during installation

Il driver, incluso, è fornito con una corrente di uscita impostata a 600 mA ma può essere regolato in installazione

▶ 500 mA 40 W 6083 lm  
▶ 550 mA 44 W 6529 lm

**Light source**  
Sorgente luminosa **B**

LED  
3000 K  
37 W  
7320 lm  
Direct light > 600 mA  
Indirect light > 350 mA  
CRI 90  
MacAdam 3-Step

LED and driver included  
LED e driver inclusi

Double switch  
Doppia accensione

The driver, included, is supplied with an output voltage of 600 mA but can be adjusted during installation

Il driver, incluso, è fornito con una corrente di uscita impostata a 600 mA ma può essere regolato in installazione

▶ 500 mA 40 W 6385 lm  
▶ 550 mA 44 W 6853 lm

Net weight Peso netto	3,90 kg 8,60 lbs	Pack Colli	1	Energy class Classe energetica	C
--------------------------	---------------------	---------------	---	-----------------------------------	---

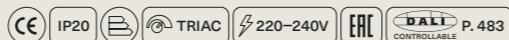

CATEGORY **CEILING LAMP** **NEW LAMP**

### Tidal 75

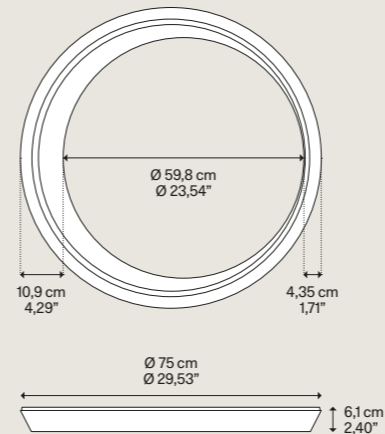

DESIGN Needs Studio, 2024

Metal structure Montatura in metallo	Code Codice <b>A</b>	Code Codice <b>B</b>
Matte White - 9010 Bianco Opaco - 9010	19932 1027	19932 1030
Matte Black - 9005 Nero Opaco - 9005	19932 2027	19932 2030
Extra Matte Champagne Champagne Extra Opaco	19932 4527	19932 4530
Terra Terra	19932 6727	19932 6730

**Light source**  
Sorgente luminosa **A**

LED  
2700 K  
46 W  
8589 lm  
Direct light > 700 mA  
Indirect light > 550 mA  
CRI 90  
MacAdam 3-Step

LED and driver included  
LED e driver inclusi

Double switch  
Doppia accensione

The driver, included, is supplied with an output voltage of 700 mA but can be adjusted during installation

Il driver, incluso, è fornito con una corrente di uscita impostata a 700 mA ma può essere regolato in installazione

▶ 500 mA 39 W 6855 lm  
▶ 550 mA 43 W 7289 lm  
▶ 600 mA 47 W 7722 lm

**Light source**  
Sorgente luminosa **B**

LED  
3000 K  
46 W  
9072 lm  
Direct light > 700 mA  
Indirect light > 550 mA  
CRI 90  
MacAdam 3-Step

LED and driver included  
LED e driver inclusi

Double switch  
Doppia accensione

The driver, included, is supplied with an output voltage of 700 mA but can be adjusted during installation

Il driver, incluso, è fornito con una corrente di uscita impostata a 700 mA ma può essere regolato in installazione

▶ 500 mA 39 W 7236 lm  
▶ 550 mA 43 W 7695 lm  
▶ 600 mA 47 W 8154 lm

Net weight Peso netto	5,38 kg 11,86 lbs	Pack Colli	1	Energy class Classe energetica	C
--------------------------	----------------------	---------------	---	-----------------------------------	---

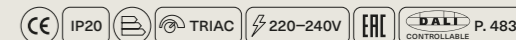

Light emission Emissione luminosa	Tidal 45			Tidal 60			Tidal 75		
<b>A</b> Direct light emission Emissione di luce diretta	2700 K	3600 lm	-	2700 K	4463 lm	500 mA	2700 K	4335 lm	500 mA
					4909 lm	550 mA		4769 lm	550 mA
					5355 lm	600 mA		5202 lm	600 mA
								6069 lm	700 mA
<b>B</b> Indirect light emission Emissione di luce indiretta	3000 K	3780 lm	-	3000 K	4675 lm	500 mA	3000 K	4590 lm	500 mA
					5143 lm	550 mA		5049 lm	550 mA
					5610 lm	600 mA		5508 lm	600 mA
								6426 lm	700 mA



# Shift

Designed by Marco Piva

Year 2025

*Shift* is a wall lamp that lets the light speak. Compact and elegant, it draws on the clean lines of contemporary architecture, softened by gently rounded corners. With its minimalist design and neutral finishes, *Shift* blends seamlessly into its surroundings, nearly disappearing to enhance the interplay of light and space. Inside, the LED light source optimises the lamp's geometric form to maximise brightness and spread light evenly, without casting shadows on the walls. With its high luminosity, *Shift* can independently illuminate medium-sized spaces, offering powerful lighting with a discreet and refined presence. Available in two sizes: small and large.

*Shift* è una lampada da parete che lascia parlare soltanto la luce. Compatta ed elegante, richiama le linee rigorose dell'architettura contemporanea per poi addolcirsi negli angoli leggermente smussati. Grazie al suo design minimale e alle finiture neutre, si fonde con l'ambiente fino quasi a scomparire per assecondare e stimolare le interazioni tra luce e spazio. Al suo interno, la sorgente luminosa a LED sfrutta la forma geometrica della lampada per massimizzare la resa luminosa e irradiare la luce in modo uniforme, senza proiettare ombre sulle pareti. Con la sua elevata potenza luminosa, *Shift* riesce a illuminare da sola anche spazi di medie dimensioni per offrire soluzioni di luce altamente performanti con una presenza discreta e raffinata, disponibile in due versioni – small e large.

Go to the technical info [+](#) Click to discover more [↓](#)

Shift COD. 215	CATEGORY LAMP		TYPE OF LIGHT	
	Wall	Parete	Indirect light	Luce indiretta
				

NEW LAMP



Shift large and small, FINISH Matte Black.









Shift large, FINISH Natural Brown.



Shift small, FINISH Natural Brown.



Shift large, FINISH Matte White.





Shift small, lighting effect with clear screen, FINISH Matte Champagne.



Shift small, lighting effect with frosted screen, FINISH Matte Champagne.

*Shift* is equipped with two interchangeable screens. It comes with a transparent screen that can be replaced with a frosted screen (included), to personalise the *light* emission and achieve a more diffuse and less distributed effect in *space*.

*Shift* è dotata di due schermi intercambiabili. Viene fornita preassemblata con uno schermo trasparente che può essere sostituito con uno schermo sabbato (in dotazione), per personalizzare l'emissione della *luce* e ottenere un effetto più diffuso e meno distribuito nello *spazio*.



*Shift* est une applique qui laisse parler uniquement la lumière. Compacte et élégante, elle évoque les lignes rigoureuses de l'architecture contemporaine pour ensuite légèrement émousser ses angles. Grâce à son design minimaliste et ses finitions neutres, elle se fond dans l'environnement jusqu'à quasiment disparaître pour accompagner et stimuler les interactions entre la lumière et l'espace. À l'intérieur, la source de lumière LED exploite la forme géométrique de la lampe pour optimiser le rendement lumineux et rayonner la lumière uniformément, sans ombres sur les murs. Avec sa grande puissance lumineuse, *Shift* peut éclairer à elle seule des espaces de taille moyenne pour offrir des solutions d'éclairage hautement performantes avec une présence discrète et raffinée. Disponible en deux versions : small et large. ●FR

*Shift* ist eine Wandleuchte, die ausschließlich das Licht zur Geltung kommen lässt. Kompakt und elegant, verweist sie auf die strengen Linien der zeitgenössischen Architektur, um dann in den leicht abgerundeten Ecken zu verfließen. Dank ihres minimalistischen Designs und ihrer neutralen Ausführungen verschmilzt sie mit dem Ambiente, bis sie nahezu vollständig davon aufgenommen wird, um das Zusammenspiel zwischen Licht und Raum zu unterstützen und zu stimulieren. In ihrem Inneren nutzt die LED-Lichtquelle die geometrische Form der Leuchte, um die Lichtleistung zu maximieren und das Licht gleichmäßig abzustrahlen, ohne Schatten auf die Wände zu projizieren. Mit ihrer hohen Leuchtkraft ermöglicht *Shift*, selbst mittelgroße Umgebungen zu erhellen und bietet leistungsstarke Beleuchtungslösungen mit einer diskreten und raffinierten, in zwei Versionen erhältlichen Präsenz – small und large. ●DE

*Shift* es una lámpara de pared que sólo deja hablar a la luz. Compacta y elegante, evoca las líneas rigurosas de la arquitectura contemporánea y luego se suaviza en las esquinas ligeramente redondeadas. Gracias a su diseño minimalista y los acabados neutros, se integra en el entorno hasta casi desaparecer para favorecer y estimular las interacciones entre la luz y el espacio. En el interior, la fuente luminosa LED aprovecha la forma geométrica de la lámpara para maximizar el rendimiento luminoso e irradiar la luz uniformemente, sin proyectar sombras en las paredes. Con su elevada potencia luminosa, *Shift* es capaz de iluminar por sí sola incluso espacios de tamaño medio para ofrecer soluciones de iluminación de alto rendimiento con una presencia discreta y refinada, disponible en dos versiones – small y large. ●ES

*Shift* – это настенный светильник, в котором на первый план выходит свет. Компактный и элегантный светильник, напоминающий строгие линии современной архитектуры, смягченной слегка закругленными углами. Благодаря своему минималистскому дизайну и нейтральным отделкам он сливается почти до полного исчезновения с окружающим пространством, поддерживая и усиливая взаимодействие света и пространства. Светодиодный источник света, расположенный внутри, использует геометрическую форму лампы, чтобы максимально усилить светоотдачу и равномерно излучать свет, не отбрасывая теней на стены. Благодаря высокой мощности освещения *Shift* способен самостоятельно освещать помещения средней площади, обеспечивая высокоэффективные световые решения и сдержанный и изысканный стиль. Светильник доступен в двух версиях – small и large. ●RU

*Shift*是一款仅让光线来叙述的壁灯。紧凑且优雅,呼应当代建筑的严谨线条,以便之后在略微圆钝的角落里变得柔和。得益于其简约的设计和中性的饰面,它与环境完美相融,直到近乎销声匿迹,以顺应并刺激光与空间之间的相互作用。在其内部,LED光源利用灯体的几何形状来最大限度地提高光线输出量并以均匀方式让光线四射,但不会在墙壁上投射阴影。凭借其高光功率,*Shift*甚至可以自行照亮中等大小的空间,以提供低调且精致的高性能照明解决方案。共有小号和大号两个版本可供选择。●ZH

CATEGORY WALL LAMP NEW LAMP

## Shift small

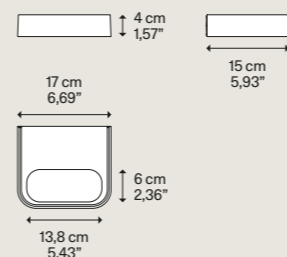

### Light source Sorgente luminosa

LED  
2700 K  
16 W  
2495 lm  
500 mA  
CRI 90  
MacAdam 3-Step

LED and driver included  
LED e driver inclusi

Net weight 1,60 kg  
Peso netto 3,52 lbs  
Pack Colli 1  
Energy class Classe energetica D

### Light source Sorgente luminosa

LED  
3000 K  
16 W  
2580 lm  
500 mA  
CRI 90  
MacAdam 3-Step

LED and driver included  
LED e driver inclusi

DESIGN Marco Piva, 2025

### Create the product code Crea il codice prodotto

Complete the missing piece ( ) by adding the number that identifies the type of dimming.

Completa il tassello mancante ( ) aggiungendo il numero che identifica la tipologia di dimmerazione.



### Type of dimming Tipo di dimmerazione

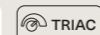

### Metal structure Montatura in metallo

Matte White – 9010  
Bianco Opaco – 9010

Matte Black – 9005  
Nero Opaco – 9005

Extra Matte Champagne  
Champagne Extra Opaco

Natural Brown NSCS8005Y50R NEW  
Testa di Moro NSCS8005Y50R

### Code Codice

2155

1027

### Code Codice

2155

1030

2155

2030

2155

4527

2155

4530

2155

6927

2155

6930

### Complete code Completa codice

1

3



NEW LAMP

## Shift large

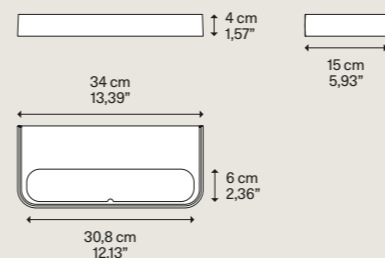

### Light source Sorgente luminosa

LED  
2700 K  
32,5 W  
5085 lm  
700 mA  
CRI 90  
MacAdam 3-Step

LED and driver included  
LED e driver inclusi

Net weight 3,00 kg  
Peso netto 6,61 lbs  
Pack Colli 1  
Energy class Classe energetica D

### Light source Sorgente luminosa

LED  
3000 K  
32,5 W  
5255 lm  
700 mA  
CRI 90  
MacAdam 3-Step

LED and driver included  
LED e driver inclusi

### Create the product code Crea il codice prodotto

Complete the missing piece ( ) by adding the number that identifies the type of dimming.

Completa il tassello mancante ( ) aggiungendo il numero che identifica la tipologia di dimmerazione.



### Type of dimming Tipo di dimmerazione

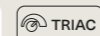

### Metal structure Montatura in metallo

Matte White – 9010  
Bianco Opaco – 9010

Matte Black – 9005  
Nero Opaco – 9005

Extra Matte Champagne  
Champagne Extra Opaco

Natural Brown NSCS8005Y50R NEW  
Testa di Moro NSCS8005Y50R

### Code Codice

2155

1027

### Code Codice

2155

1030

2155

2027

2155

2030

2155

4527

2155

4530

2155

6927

2155

6930

### Complete code Completa codice

2

4



Shift small › Wall lamp NEW LAMP



Shift large › Wall lamp NEW LAMP



### The light emission angle Angolo di emissione della luce

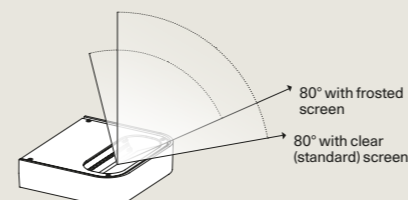



# Nautilus

Designed by Andrea Tosetto

Year 2017, 2024

Strong design and leading-edge technology come together in this family of lamps characterised by a convex lens that projects the LED light wherever its needed or most preferred, for a truly efficient and personalised result. Versatile and dynamic, either on the wall or ceiling in a variety of versions and finishes, *Nautilus* lamps satisfy a full range of lighting needs, whether functional or purely decorative, in both residential and professional contexts. *Nautilus* is also available with a *Dim-to-Warm* function, which allows users to interact by adjusting the intensity of the LED light source from 2200 to 2700 kelvin.

Design deciso e tecnologia di punta si fondono in questa famiglia di lampade caratterizzate da una lente convessa che proietta la luce a LED dove serve o dove piace di più, per un risultato di efficienza e personalizzazione. Versatili e dinamiche, a parete o a soffitto, in diverse versioni e finiture, le lampade *Nautilus* soddisfano innumerevoli esigenze di illuminazione, dalle più funzionali a quelle particolarmente decorative, sia in ambito residenziale che professionale. *Nautilus* è ora disponibile anche nella funzione *Dim-to-Warm*, che permette agli utenti di interagire con la lampada, regolando l'intensità della sorgente luminosa a LED da 2200 a 2700 Kelvin.

Go to the technical info 

Click to discover more 

Nautilus  
COD. 165

CATEGORY LAMP

Wall  
Ceiling

Parete  
Soffitto



TYPE OF LIGHT

Symmetrical diffused light  
Adjustable light

Luce simmetrica diffusa  
Luce orientabile



Nautilus and Nautilus Spot, FINISH Matte Black.







Nautilus, Dim-to-Warm from 2200 to 2700 K

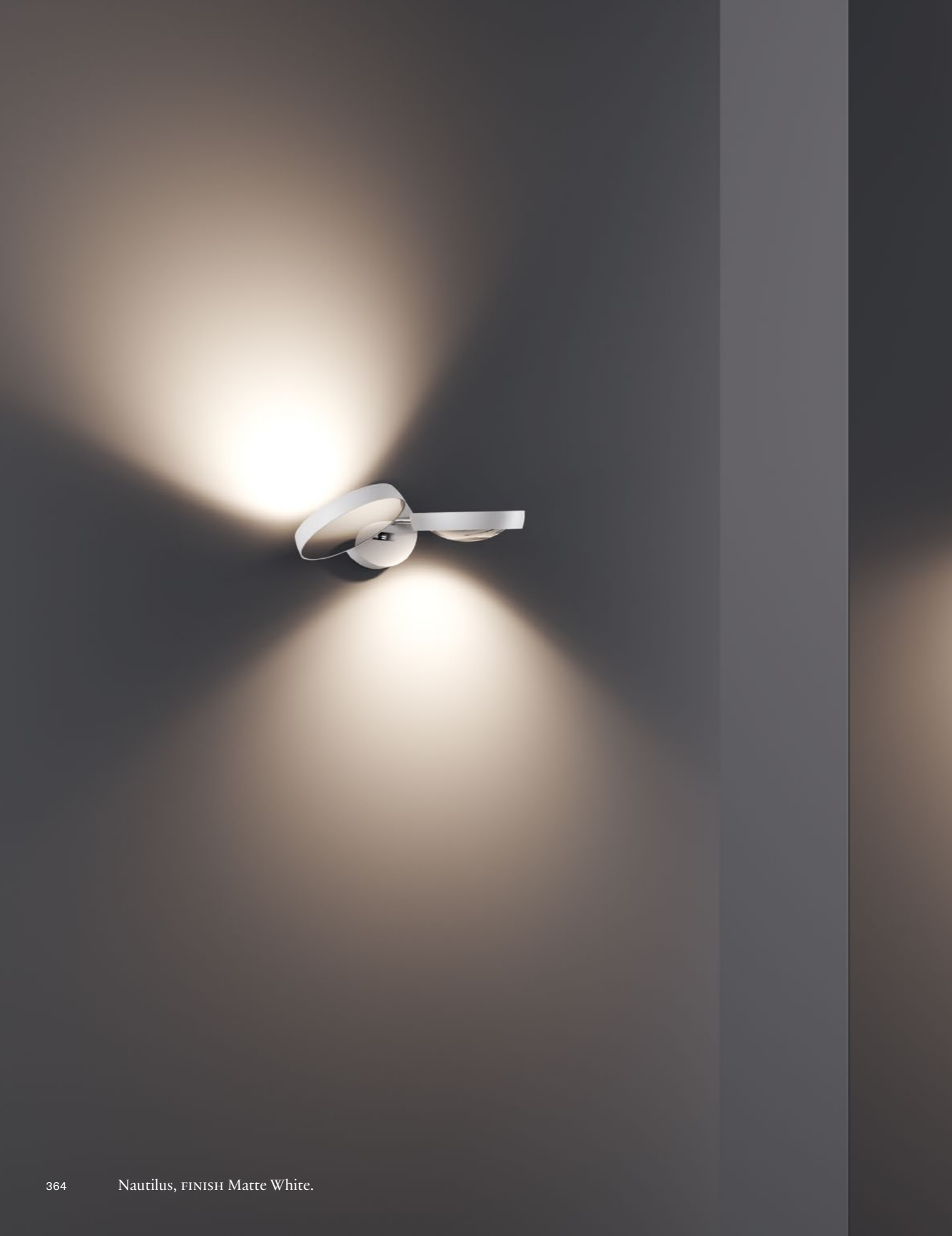
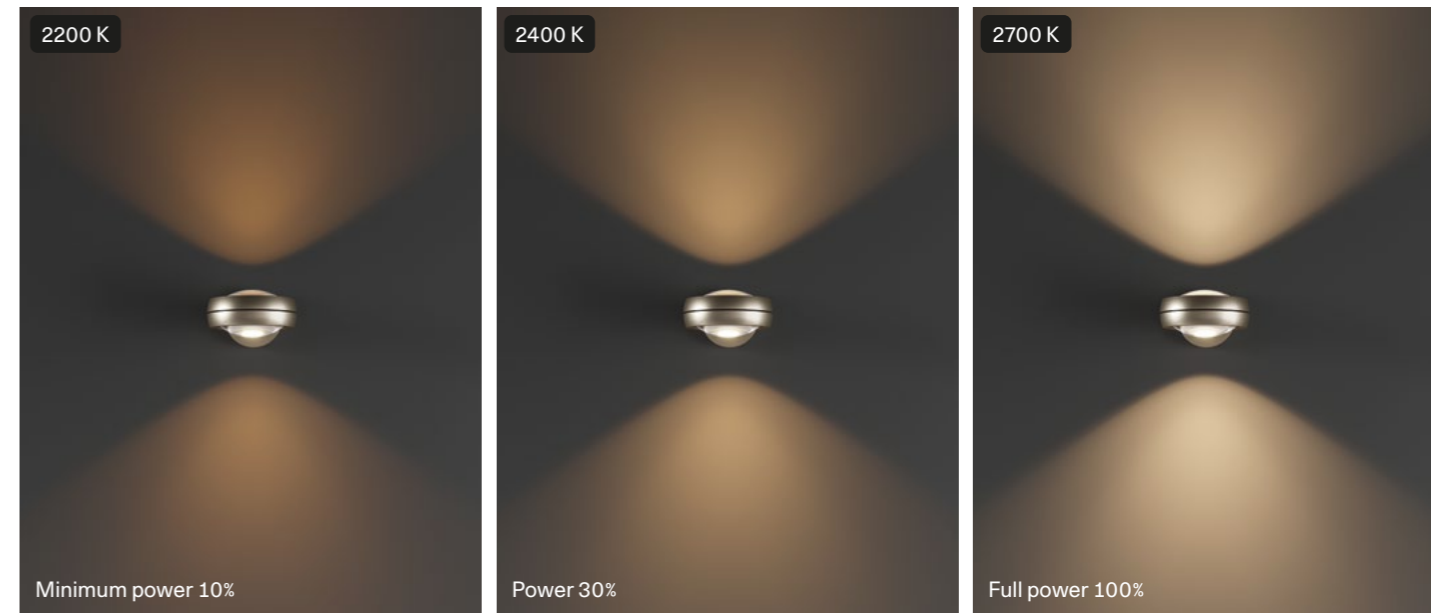

*Nautilus* is available with a *Dim-to-Warm* function, which allows users to interact by adjusting the intensity of the LED light source from 2200 to 2700 kelvin.

*Nautilus* è disponibile nella funzione *Dim-to-Warm*, che permette agli utenti di interagire con la lampada, regolando l'intensità della sorgente luminosa a LED da 2200 a 2700 Kelvin.









Nautilus, FINISH Matte White.



Nautilus, FINISH Matte Black.



Nautilus, FINISH Champagne.



Nautilus, FINISH Matte White.









Nautilus Mini, FINISH Matte White.



Nautilus Mini, FINISH Champagne.

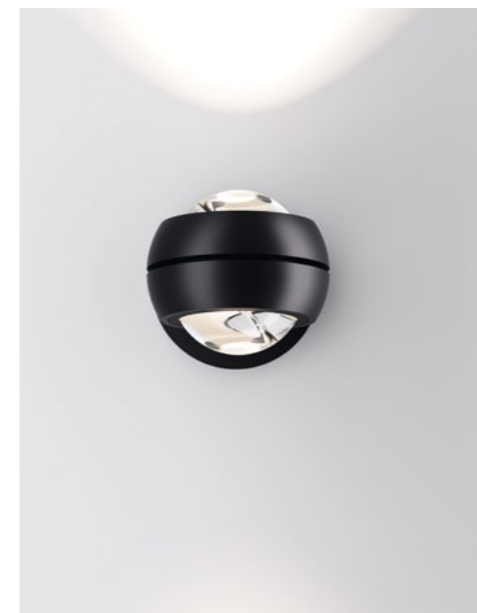

Nautilus Mini, FINISH Matte Black.



Un design impeccable et une technologie de pointe fusionnent pour cette famille de lampes caractérisées par un verre convexe qui dirige la lumière à LED où il le faut et où vous le souhaitez le plus, pour un résultat efficace et personnalisé. Polyvalentes et dynamiques, appliques ou plafonniers, en différentes versions et finitions, les lampes *Nautilus* répondent à d'innombrables besoins d'éclairage, des plus fonctionnels à ceux particulièrement décoratifs, aussi bien dans le domaine résidentiel que professionnel. *Nautilus* est aussi disponible dans la fonction *Dim-to-Warm*, qui permet aux utilisateurs d'interagir avec la lampe, en réglant l'intensité de la source lumineuse à LED de 2200 à 2700 kelvins. ●FR

Entschlossenes Design und Spitzentechnologie verschmelzen in dieser Leuchtenfamilie miteinander, die sich durch eine konvexe Linse auszeichnet, die LED-Licht dorthin projiziert, wo es benötigt wird oder am besten gefällt, um ein effizientes und individuelles Ergebnis zu erzielen. Vielseitig und dynamisch, an der Wand oder Decke, in verschiedenen Versionen und Ausführungen, erfüllen die *Nautilus* Leuchten unzählige Beleuchtungsbedürfnisse von den funktionalsten bis hin zu den besonders dekorativen, sowohl im privaten als auch im professionellen Bereich. *Nautilus* ist auch mit der Funktion *Dim-to-Warm* erhältlich, die es dem Benutzer ermöglicht,

mit der Lampe zu interagieren und die Intensität der LED-Lichtquelle von 2200 bis 2700 Kelvin zu regulieren. ●DE

El diseño decidido y la tecnología punta se fusionan en esta familia de lámparas caracterizadas por una lente convexa que proyecta la luz LED donde se necesita o donde más gusta, para un resultado eficiente y personalizado. Versátiles y dinámicas, de pared o de techo, en diferentes versiones y acabados, las lámparas *Nautilus* satisfacen innumerables necesidades de iluminación, de las más funcionales a las especialmente decorativas, tanto en ámbito residencial como profesional. *Nautilus* también está disponible en la función *Dim-to-Warm*, que permite a los usuarios interactuar con la lámpara regulando la intensidad de la fuente luminosa de LED de 2200 a 2700 grados Kelvin. ●ES

Чистый дизайн и передовые технологии сочетаются в этом семействе светильников, характеризующихся выпуклой линзой, которая проецирует свет лампы LED туда, где это необходимо или где вам больше нравится, обеспечивая эффективность и персонализацию. Светильники *Nautilus*, универсальные и динамичные, настенные или потолочные, в разных вариантах исполнения и отделки, удовлетворяют бесчисленные потребности

светового оформления, от самого функционального до особо декоративного, как в жилых, так и в профессиональных помещениях. *Nautilus* поставляется также с функцией «*Dim-to-Warm*», которая позволяет пользователям регулировать интенсивность светодиодного источника освещения от 2200 до 2700 кельвинов. ●RU

决定性的设计与最先进的技术相结合，凸透镜是该系列灯具的特征，该凸透镜可将LED光投射到需要的地方或是您最喜欢的地方，以提高效率和定制化。*Nautilus*灯具具有多功能性和动态性，可以壁式安装或吸顶安装，具有不同的版本和颜色，可以满足无数的照明需求，从最实用的功能到特别装饰性的功能，无论是在住宅还是在专业环境中。*Nautilus*还具备*Dim-to-Warm*调光功能，该功能使用户可以与灯具互动，从而将光源强度从2200K调节至2700K。●ZH

#### Nautilus » Wall lamp

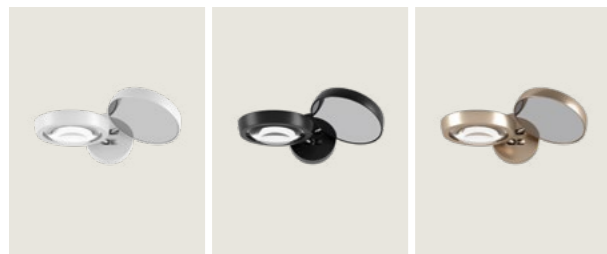

#### Nautilus Mini » Wall lamp

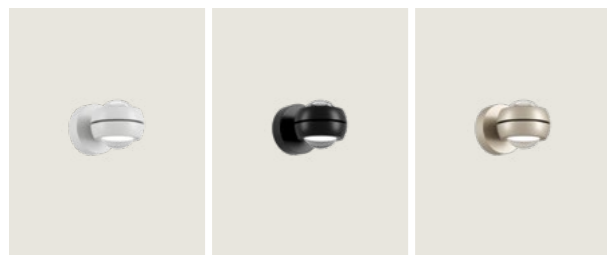

#### Nautilus » Ceiling lamp

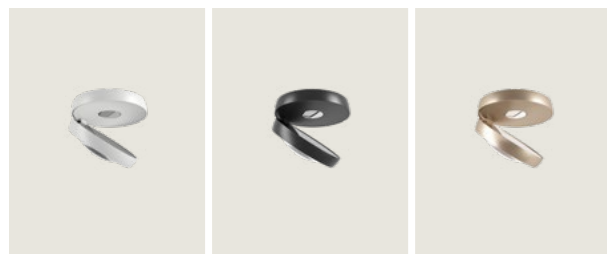

#### Nautilus Spot » Ceiling lamp

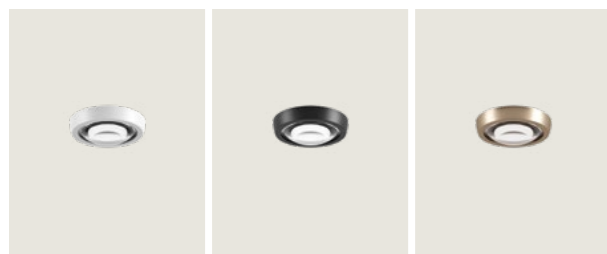

#### CATEGORY WALL LAMP

### Nautilus Dim-to-Warm

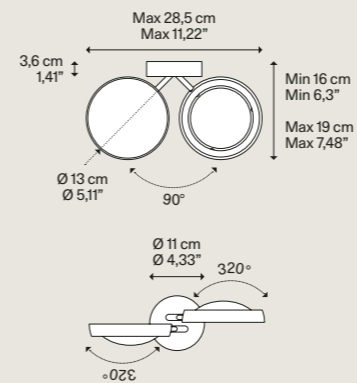

Net weight	1,80 kg	Pack	1	Energy class	E
Peso netto	3,96 lbs	Colli		Classe energetica	

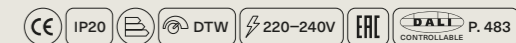

#### DESIGN Andrea Tosetto, 2024

Metal structure Montatura in metallo	Code Codice
Matte White - 9010 Bianco Opaco - 9010	16553 1926
Matte Black - 9005 Nero Opaco - 9005	16553 2926
Champagne Champagne	16553 4926

#### Light source Sorgente luminosa

LED  
Dim-to-Warm  
FROM 2200 K  
TO 2700 K  
2x 7 W  
2000 lm  
220-240 V  
CRI 90  
MacAdam 3-Step

LED and driver included  
LED e driver inclusi

#### Dim-to-Warm

► 10%	2200 K	160 lm
► 30%	2400 K	520 lm
► 60%	2600 K	1200 lm
► 100%	2700 K	2000 lm

#### Adjustable light Luce orientabile

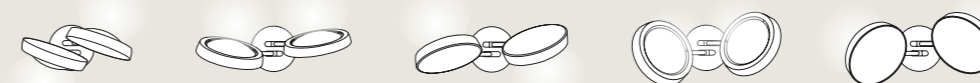

#### CATEGORY WALL LAMP

### Nautilus

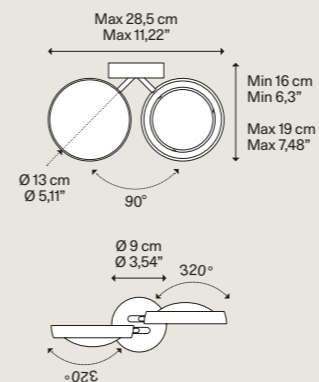

Net weight	1,15 kg	Pack	1	Energy class	F
Peso netto	2,54 lbs	Colli		Classe energetica	

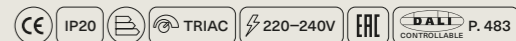

#### DESIGN Andrea Tosetto, 2017

Metal structure Montatura in metallo	Code Codice	Code Codice
Matte White - 9010 Bianco Opaco - 9010	16550 1927	16550 1930
Matte Black - 9005 Nero Opaco - 9005	16550 2927	16550 2930
Champagne Champagne	16550 4927	16550 4930

#### Light source Sorgente luminosa

AC LED  
2700 K  
2x 12 W  
1990 lm  
220-240 V  
CRI 90  
MacAdam 3-Step

LED included  
LED incluso

#### Light source Sorgente luminosa

AC LED  
3000 K  
2x 12 W  
2170 lm  
220-240 V  
CRI 90  
MacAdam 3-Step

LED included  
LED incluso

► LED sources with direct power supply to the AC line voltage – driver not required.  
Dimmable with phase cut dimmer.

► LED con alimentazione diretta a tensione di rete – non necessita di driver.  
Dimmerabile con varialuce a taglio di fase.

#### Adjustable light Luce orientabile

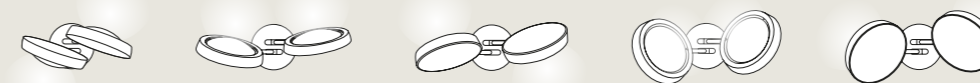



## CATEGORY WALL LAMP

## Nautilus Mini

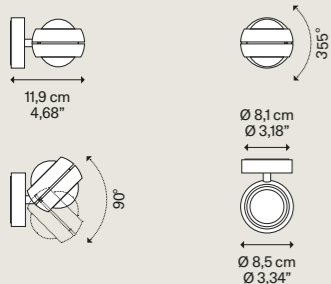

DESIGN Andrea Tosetto, 2017

Metal structure Montatura in metallo	Code Codice	<b>A</b>	Code Codice	<b>B</b>
Matte White – 9010 Bianco Opaco – 9010	16552 1027		16552 1030	
Matte Black – 9005 Nero Opaco – 9005	16552 2027		16552 2030	
Champagne Champagne	16552 4527		16552 4530	

Light source Sorgente luminosa		<b>A</b>
AC LED		
2700	K	
12	W	
950	lm	
220–240	V	
CRI 90		
MacAdam 3-Step		
LED included LED incluso		

Light source Sorgente luminosa		<b>B</b>
AC LED		
3000	K	
12	W	
1030	lm	
220–240	V	
CRI 90		
MacAdam 3-Step		
LED included LED incluso		

Net weight Peso netto	0,75 kg 1,65 lbs	Pack Colli	1	Energy class Classe energetica	G
--------------------------	---------------------	---------------	---	-----------------------------------	---

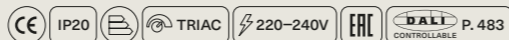
Adjustable light  
Luce orientabile

## CATEGORY CEILING LAMP

## Nautilus

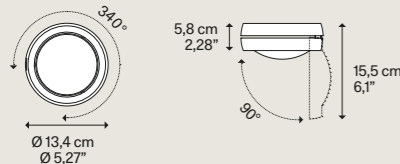

DESIGN Andrea Tosetto, 2017

Metal structure Montatura in metallo	Code Codice	<b>A</b>	Code Codice	<b>B</b>
Matte White – 9010 Bianco Opaco – 9010	16530 1027		16530 1030	
Matte Black – 9005 Nero Opaco – 9005	16530 2027		16530 2030	
Champagne Champagne	16530 4527		16530 4530	

Light source Sorgente luminosa		<b>A</b>
AC LED		
2700	K	
12	W	
995	lm	
220–240	V	
CRI 90		
MacAdam 3-Step		
LED included LED incluso		

Light source Sorgente luminosa		<b>B</b>
AC LED		
3000	K	
12	W	
1085	lm	
220–240	V	
CRI 90		
MacAdam 3-Step		
LED included LED incluso		

Net weight Peso netto	1,10 kg 2,43 lbs	Pack Colli	1	Energy class Classe energetica	F
--------------------------	---------------------	---------------	---	-----------------------------------	---

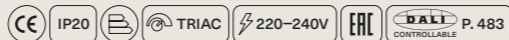
Adjustable light  
Luce orientabile

► LED sources with direct power supply to the AC line voltage – driver not required.  
Dimmable with phase cut dimmer.

► LED con alimentazione diretta a tensione di rete – non necessita di driver.  
Dimmerabile con varialuce a taglio di fase.

## CATEGORY CEILING LAMP

## Nautilus Spot

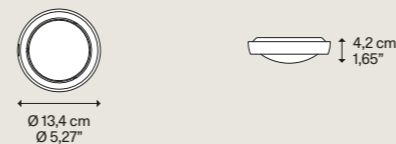

DESIGN Andrea Tosetto, 2020

Metal structure Montatura in metallo	Code Codice	<b>A</b>	Code Codice	<b>B</b>
Matte White – 9010 Bianco Opaco – 9010	16560 1027		16560 1030	
Matte Black – 9005 Nero Opaco – 9005	16560 2027		16560 2030	
Champagne Champagne	16560 4527		16560 4530	

Light source Sorgente luminosa		<b>A</b>
AC LED		
2700	K	
10	W	
945	lm	
220–240	V	
CRI 90		
MacAdam 3-Step		
LED included LED incluso		

Light source Sorgente luminosa		<b>B</b>
AC LED		
3000	K	
10	W	
950	lm	
220–240	V	
CRI 90		
MacAdam 3-Step		
LED included LED incluso		

Net weight Peso netto	0,56 kg 1,23 lbs	Pack Colli	1	Energy class Classe energetica	F
--------------------------	---------------------	---------------	---	-----------------------------------	---

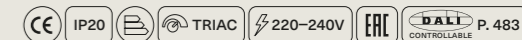

► LED sources with direct power supply to the AC line voltage – driver not required.  
Dimmable with phase cut dimmer.

► LED con alimentazione diretta a tensione di rete – non necessita di driver.  
Dimmerabile con varialuce a taglio di fase.



# Puzzle Round

Designed by Studio Italia Design

Year 2016

With its soft shapes, flexible joints and LED light source, *Puzzle Round* can be adjusted at will to create striking light effects on walls and ceilings. The unobtrusive aesthetics and the four available finishes, now including Champagne, make it perfect for the most varied living contexts.

Con le sue forme morbide, i giunti flessibili e la sorgente luminosa a LED, *Puzzle Round* può essere regolata a piacimento per creare suggestivi giochi di luce su pareti e soffitti. L'estetica discreta e le quattro finiture disponibili, ora anche Champagne, la rendono perfetta per i più svariati contesti abitativi.

[Go to the technical info](#) [Click to discover more](#)

Puzzle Round  
cod. 159

CATEGORY LAMP		TYPE OF LIGHT	
Wall	Parete	Diffused light	Luce diffusa
Ceiling	Soffitto	Indirect light	Luce indiretta
		Adjustable light	Luce orientabile

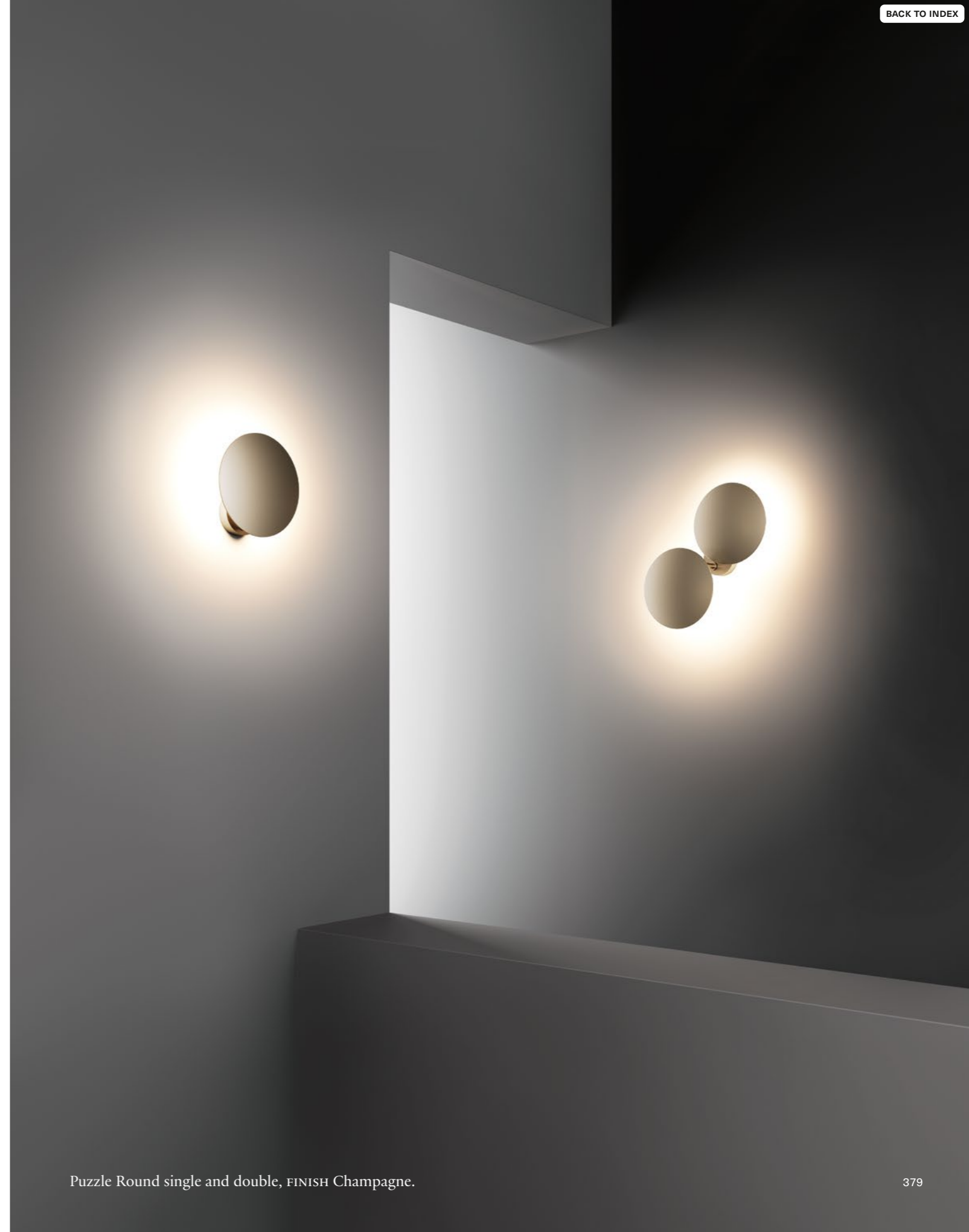



Puzzle Round single and double, FINISH Champagne.





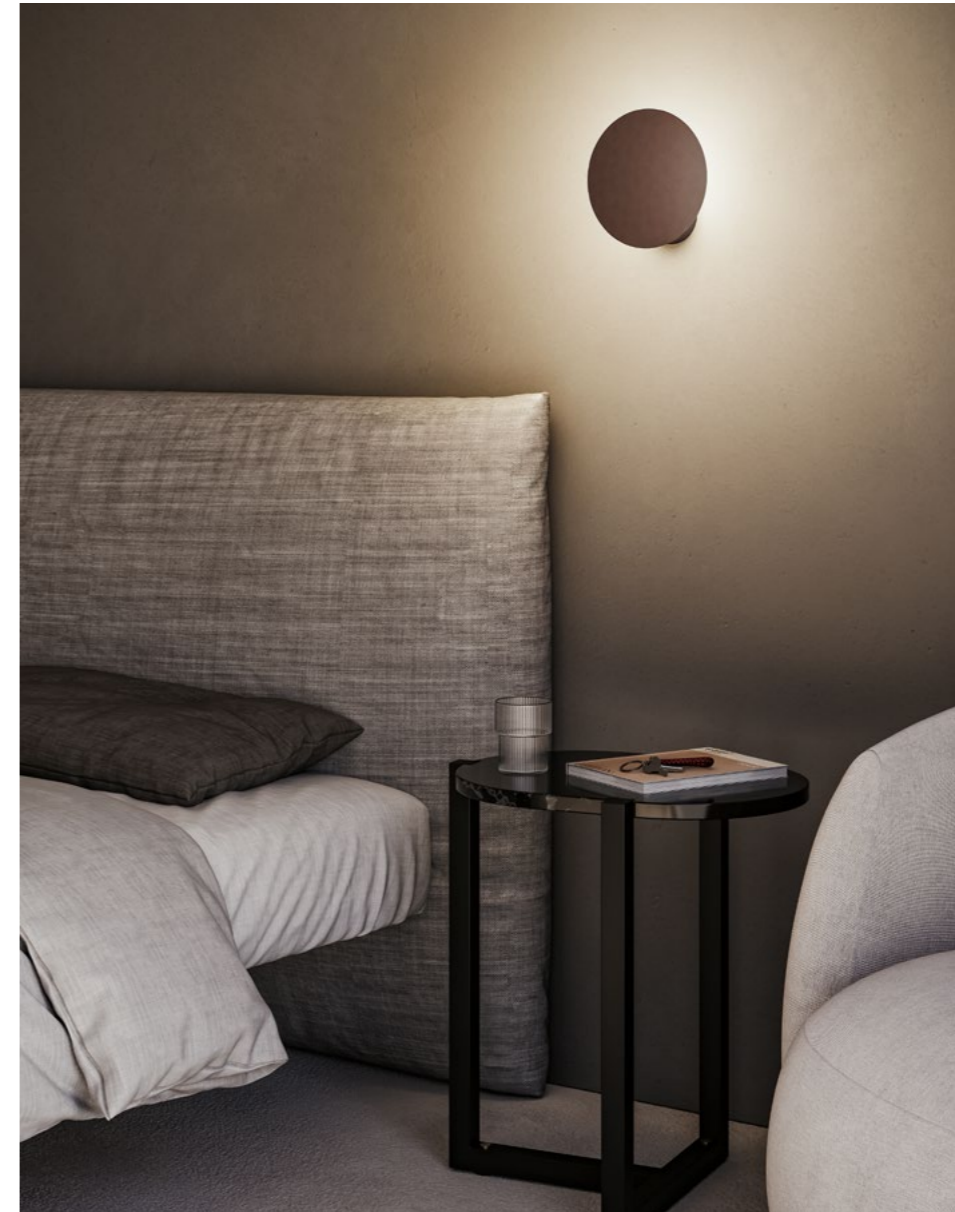



Puzzle Round single, FINISH Coppery Bronze.







Avec ses formes souples, les joints flexibles et la source lumineuse à LED, *Puzzle Round* peut être réglée à discrétion pour créer des jeux de lumière suggestifs sur les murs et les plafonds. Son esthétique discrète et les quatre finitions disponibles, y compris le Champagne, la rendent parfaite pour des contextes de vie variés. ●FR

Durch ihre weichen Formen, die flexiblen Gelenke und die LED-Lichtquelle kann *Puzzle Round* nach Belieben eingestellt werden, um wunderbare Lichtspiele an Wänden und Decken entstehen zu lassen. Die unauffällige Ästhetik und die vier verfügbaren Ausführungen – jetzt auch Champagner – machen die Leuchte perfekt für verschiedene Wohnbereiche. ●DE

Con sus formas suaves, articulaciones flexibles y fuente de luz LED, *Puzzle Round* puede ajustarse a voluntad para crear sorprendentes efectos de luz en paredes y techos. La estética discreta y los cuatro acabados disponibles, ahora incluyendo Champán, lo hacen perfecto para una amplia variedad de entornos. ●ES

Благодаря своим мягким формам, гибким соединительным элементам и источнику света LED, светильник *Puzzle Round* можно регулировать по желанию для создания эффектной игры света на стенах и потолках. Неброский дизайн и четыре доступных варианта отделки, теперь включающие Champagne, делают его идеальным для разных жилых контекстов. ●RU

柔软的外形，灵活的接头和LED光源，*Puzzle Round*可以根据需要进行调整，以在墙壁和天花板上营造出光线的暗示性。谨慎的美学设计以及如今包含香槟色在内的四种可用颜色，使其非常适合各种房屋环境。●ZH

#### Puzzle Round single ↘ Wall lamp

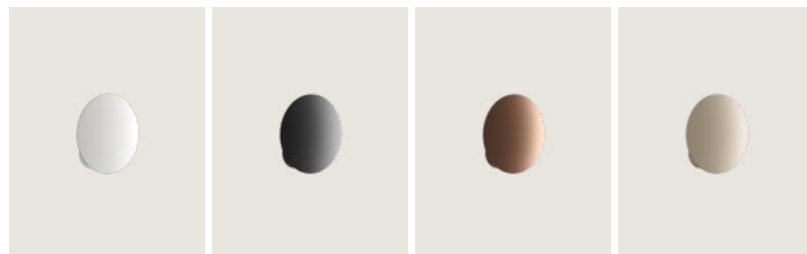

#### Puzzle Round single ↘ Ceiling lamp



#### Puzzle Round double ↘ Wall lamp

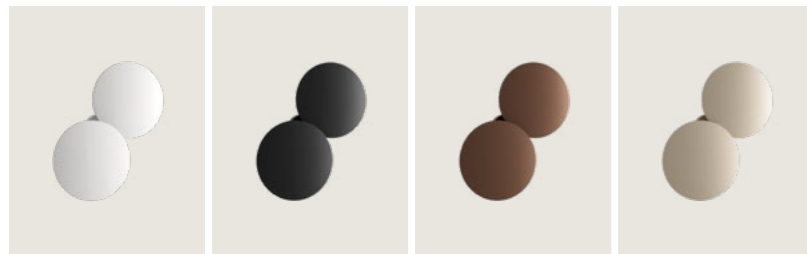

#### Puzzle Round double ↘ Ceiling lamp



#### CATEGORY WALL LAMP CEILING LAMP

### Puzzle Round single

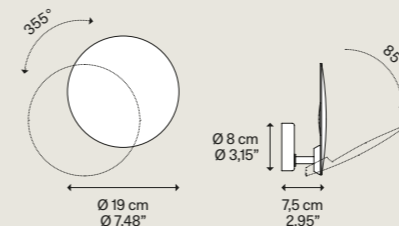

#### DESIGN Studio Italia Design, 2016

#### Metal structure Montatura in metallo

	Code Codice <sup>A</sup>	Code Codice <sup>B</sup>
Matte White – 9016 Bianco Opaco – 9016	15941 1027	15941 1030
Matte Black – 9005 Nero Opaco – 9005	15941 2027	15941 2030
Coppery Bronze Bronzo Ramato	15941 3527	15941 3530
Champagne Champagne	15941 4527	15941 4530

#### Light source Sorgente luminosa <sup>A</sup>

AC LED  
2700 K  
16 W  
1750 lm  
220–240 V  
CRI 92  
MacAdam 3-Step

LED included  
LED incluso

#### Light source Sorgente luminosa <sup>B</sup>

AC LED  
3000 K  
16 W  
1850 lm  
220–240 V  
CRI 92  
MacAdam 3-Step

LED included  
LED incluso

Net weight Peso netto	0,60 kg 1,32 lbs	Pack Colli	1	Energy class Classe energetica	E
--------------------------	---------------------	---------------	---	-----------------------------------	---

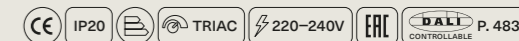

#### Adjustable light Luce orientabile



### Puzzle Round double

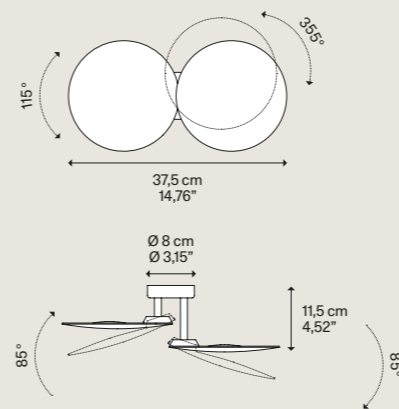

#### Metal structure Montatura in metallo

	Code Codice <sup>A</sup>	Code Codice <sup>B</sup>
Matte White – 9016 Bianco Opaco – 9016	15942 1027	15942 1030
Matte Black – 9005 Nero Opaco – 9005	15942 2027	15942 2030
Coppery Bronze Bronzo Ramato	15942 3527	15942 3530
Champagne Champagne	15942 4527	15942 4530

#### Light source Sorgente luminosa <sup>A</sup>

AC LED  
2700 K  
2x 16 W  
3500 lm  
220–240 V  
CRI 92  
MacAdam 3-Step

LED included  
LED incluso

#### Light source Sorgente luminosa <sup>B</sup>

AC LED  
3000 K  
2x 16 W  
3700 lm  
220–240 V  
CRI 92  
MacAdam 3-Step

LED included  
LED incluso

Net weight Peso netto	1,10 kg 2,43 lbs	Pack Colli	1	Energy class Classe energetica	E
--------------------------	---------------------	---------------	---	-----------------------------------	---

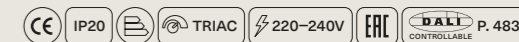

#### Adjustable light Luce orientabile

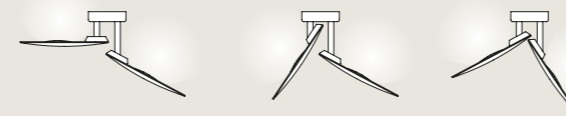

► LED sources with direct power supply to the AC line voltage – driver not required. Dimmable with phase cut dimmer.

► LED con alimentazione diretta a tensione di rete – non necessita di driver. Dimmerabile con varialuce a taglio di fase.



# Puzzle

Designed by Studio Italia Design

Year 2014

Essential forms in metal, square and rectangular, which seem to disappear in the ceiling or wall. Clear-cut geometries that create suggestive plays of light on walls and ceilings, making for a truly personalised atmosphere. With *Puzzle* lamps, light becomes the feature element of living spaces, creating soft, geometric effects.

Forme essenziali in metallo, quadrati e rettangoli che sembrano scomparire nel soffitto o nella parete. Geometria rigorose che possono essere regolate a piacimento per creare suggestivi giochi di luce su pareti e soffitti, rendendo l'atmosfera del tutto personale. Le lampade *Puzzle* rendono la luce il vero ornamento degli ambienti abitativi creando effetti di morbide geometrie.

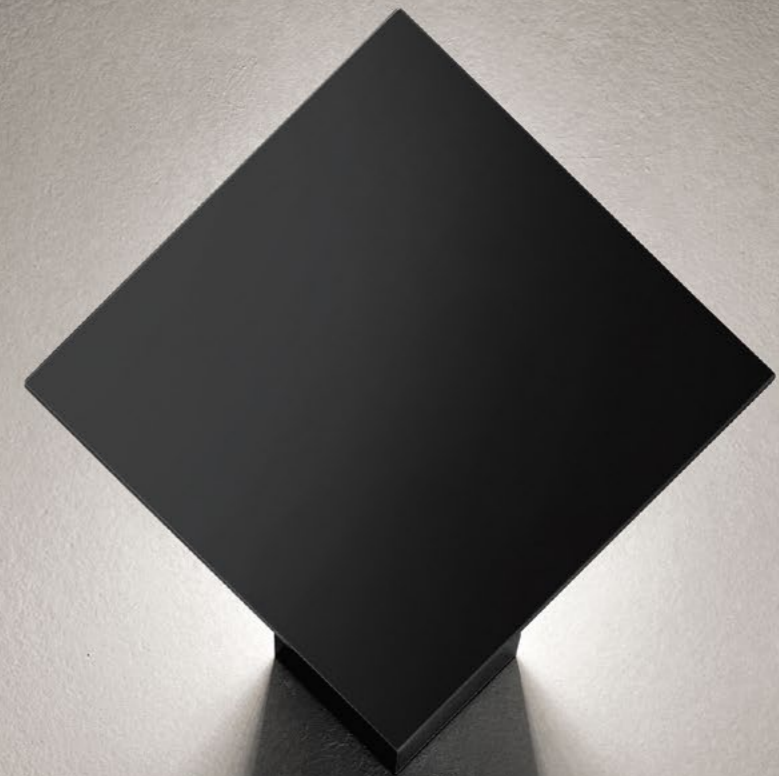

Go to the technical info [+](#) Click to discover more [↓](#)

Puzzle  
COD. 146

CATEGORY LAMP		TYPE OF LIGHT	
Wall	Parete	Diffused light	Luce diffusa
Ceiling	Soffitto	Indirect light	Luce indiretta





390 Puzzle double square, FINISH Matte White.



Puzzle square & rectangle, FINISH Matte White.



Puzzle double square, FINISH Matte Black.



Formes essentielles en métal, carrées et rectangulaires qui semblent disparaître dans le plafond ou le mur. Des géométries rigoureuses qui créent des jeux de lumières suggestifs sur les murs et plafonds pour créer une atmosphère personnelle. Les lampes *Puzzle* font de la lumière une décoration des espaces de vie et créent des effets géométriques harmonieux. ●FR

Einfache Formen aus Metall, quadratisch und rechteckig, die in der Decke oder in der Wand zu verschwinden scheinen. Klare Geometrien, die an Wänden und Decken wunderbare Lichtspiele erzeugen, um die Atmosphäre vollkommen persönlich zu gestalten. Die Leuchten *Puzzle* machen das Licht zum wahren Ornament von Wohnräumen und lassen Effekte mit weicher geometrischer Form entstehen. ●DE

Formas esenciales de metal, cuadrados y rectángulos que parecen desaparecer en el techo o la pared. Rigurosas geometrías que crean sugestivos efectos de luz en paredes y techos haciendo que la atmósfera sea completamente personal. Las lámparas *Puzzle* hacen que la luz sea el verdadero ornamento de los espacios habitables, creando efectos de geometrías suaves. ●ES

Простые формы из металла, квадраты и прямоугольники, которые как бы исчезают в потолке или стене. Строгие геометрические формы, которые можно отрегулировать по своему вкусу, создавая живописную игру света на стенах и потолках и полностью персонализируя атмосферу. Светильники *Puzzle* превращают свет в истинный декоративный элемент жилых интерьеров, создавая мягкие геометрические эффекты. ●RU

基本的金属形状，是似乎在吸顶灯和壁灯中消失的正方形和矩形。严格的几何形状可以随意调节，在墙壁和天花板上营造出暗示性的光线，使氛围完全个性化。*Puzzle*灯通过创造柔和的几何效果，使照明成为生活空间的真正装饰品。●ZH

CATEGORY WALL LAMP CEILING LAMP

## Puzzle single square

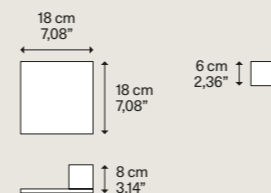

Net weight 1,16 kg 2,56 lbs Pack Colli 1 Energy class Classe energetica E

DESIGN Studio Italia Design, 2014

Metal structure  
Montatura in metallo

● Matte White - 9016  
Bianco Opaco - 9016

● Matte Black - 9005  
Nero Opaco - 9005

Code Codice A Code Codice B

14641 1027 14641 1030

14641 2027 14641 2030

Light source  
Sorgente luminosa A

AC LED  
2700 K  
16 W  
1750 lm  
220-240 V  
CRI 92  
MacAdam 3-Step

LED included  
LED incluso

Light source  
Sorgente luminosa B

AC LED  
3000 K  
16 W  
1850 lm  
220-240 V  
CRI 92  
MacAdam 3-Step

LED included  
LED incluso

CE IP20 TRIAC 220-240V EAC DALI P. 483

## Puzzle double square

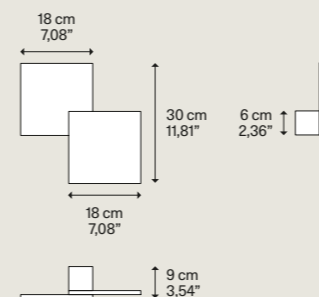

Net weight 2,00 kg 4,41 lbs Pack Colli 1 Energy class Classe energetica E

Metal structure  
Montatura in metallo

● Matte White - 9016  
Bianco Opaco - 9016

● Matte Black - 9005  
Nero Opaco - 9005

Code Codice A Code Codice B

14642 1027 14642 1030

14642 2027 14642 2030

Light source  
Sorgente luminosa A

AC LED  
2700 K  
2x 16 W  
3500 lm  
220-240 V  
CRI 92  
MacAdam 3-Step

LED included  
LED incluso

Light source  
Sorgente luminosa B

AC LED  
3000 K  
2x 16 W  
3700 lm  
220-240 V  
CRI 92  
MacAdam 3-Step

LED included  
LED incluso

CE IP20 TRIAC 220-240V EAC DALI P. 483

## Puzzle square & rectangle

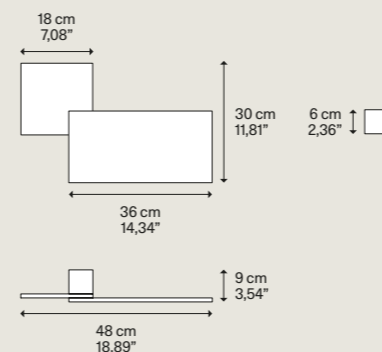

Net weight 2,91 kg 6,42 lbs Pack Colli 1 Energy class Classe energetica E

Metal structure  
Montatura in metallo

● Matte White - 9016  
Bianco Opaco - 9016

● Matte Black - 9005  
Nero Opaco - 9005

Code Codice A Code Codice B

14643 1027 14643 1030

14643 2027 14643 2030

Light source  
Sorgente luminosa A

AC LED  
2700 K  
2x 16 W  
3500 lm  
220-240 V  
CRI 92  
MacAdam 3-Step

LED included  
LED incluso

Light source  
Sorgente luminosa B

AC LED  
3000 K  
2x 16 W  
3700 lm  
220-240 V  
CRI 92  
MacAdam 3-Step

LED included  
LED incluso

CE IP20 TRIAC 220-240V EAC DALI P. 483

► LED sources with direct power supply to the AC line voltage – driver not required. Dimmable with phase cut dimmer. ► Optional backplate available.

► LED con alimentazione diretta a tensione di rete – non necessita di driver. Dimmerabile con varialuce a tagli di fase. ► Disponibile piastra a muro opzionale.

Puzzle single square › Wall lamp

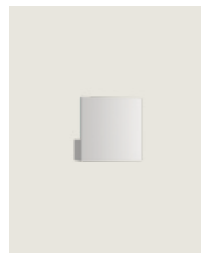

Puzzle single square › Ceiling lamp

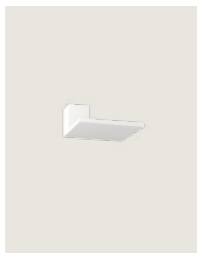

Puzzle double square › Wall lamp

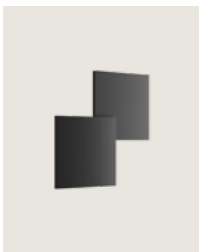

Puzzle double square › Ceiling lamp



Puzzle square & rectangle › Wall lamp

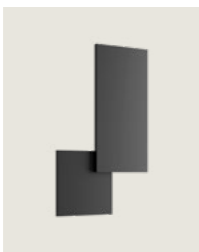

Puzzle square & rectangle › Ceiling lamp

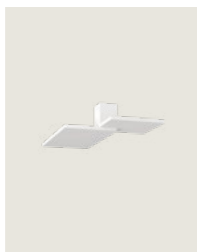



# Puzzle Mega

Designed by Studio Italia Design

Year 2019

Large geometric figures characterised by essential forms, which almost merge with the interior architecture when off, only to be surprisingly revealed as harmonies of light and shadow when lit. New matte finishes warm up the geometric panels of *Puzzle Mega*. Liquid paints that open new decorative possibilities, playing with harmonies and contrasts of colours and shapes.

Grandi figure geometriche dalle forme essenziali che quasi si fondono con l'architettura interna quando sono spente, per rivelare inaspettate armonie di luci e ombre una volta accese. Nuove finiture opache scaldano i pannelli geometrici di *Puzzle Mega*. Vernici liquide che aprono nuove possibilità decorative giocando con armonie e contrasti di colori e forme.

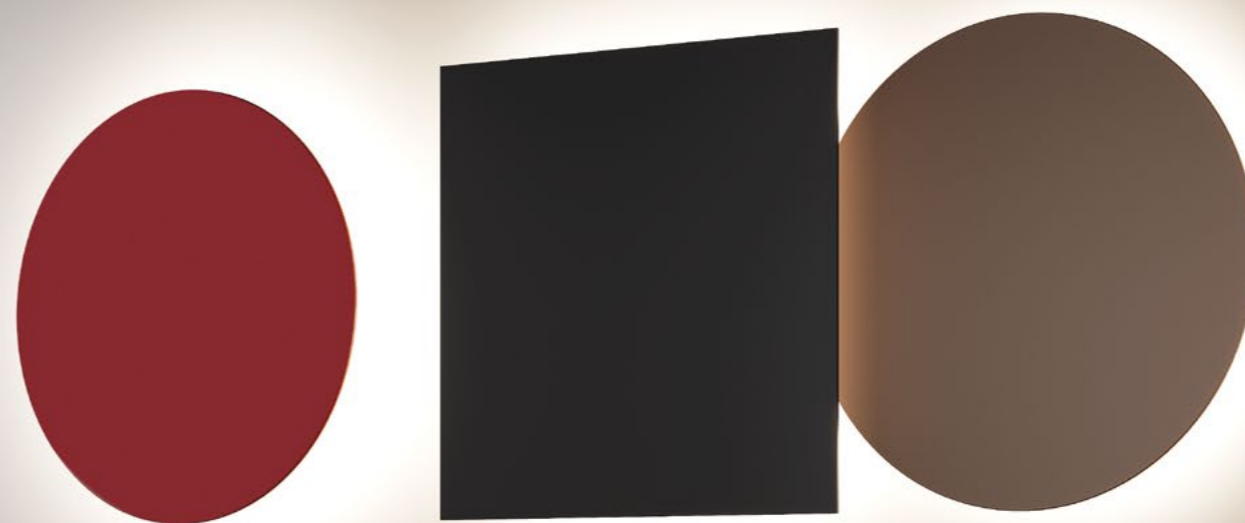

Go to the technical info [+](#) Click to discover more [↓](#)

Puzzle Mega  
COD. 167

CATEGORY LAMP		TYPE OF LIGHT	
Wall	Parete	Diffused light	Luce diffusa
Ceiling	Soffitto	Indirect light	Luce indiretta



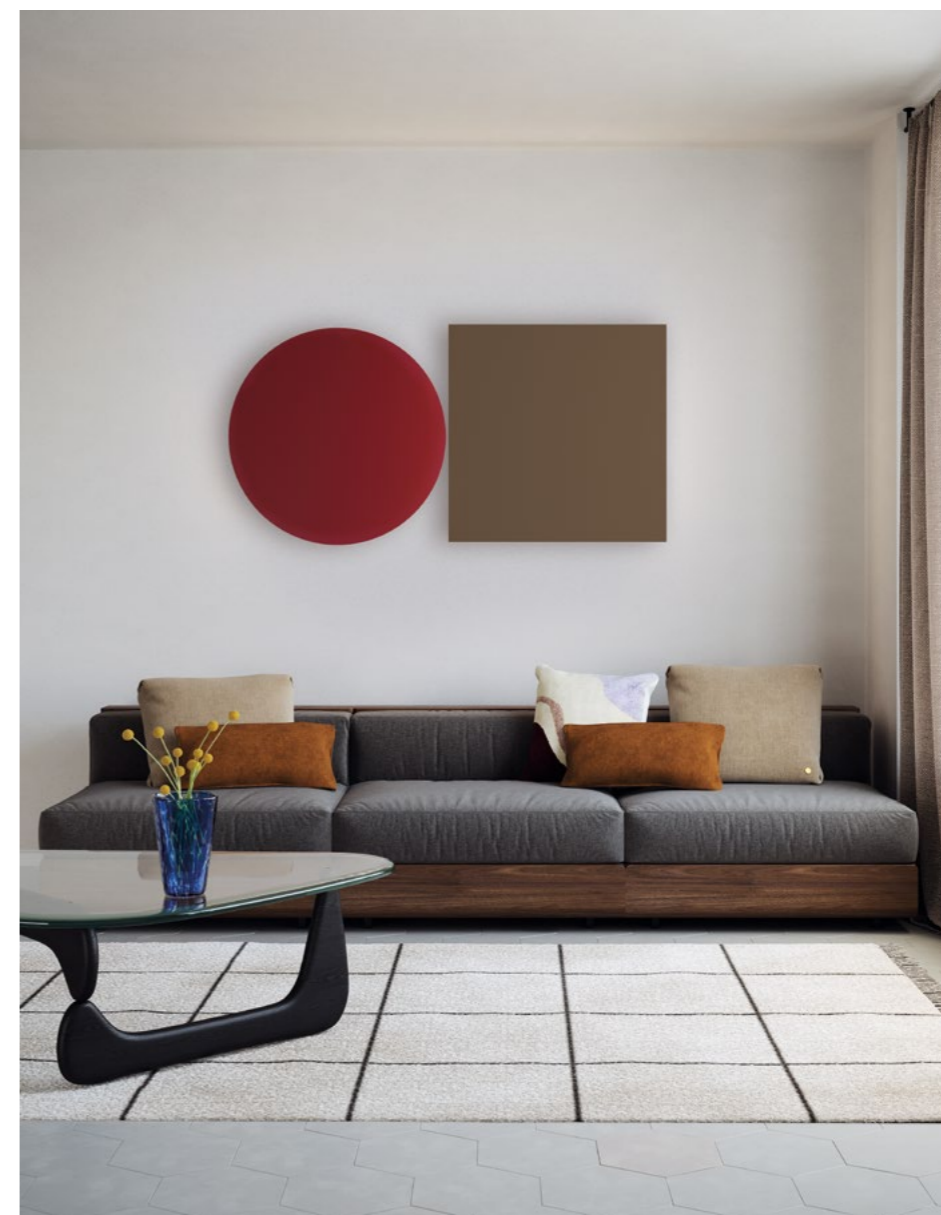
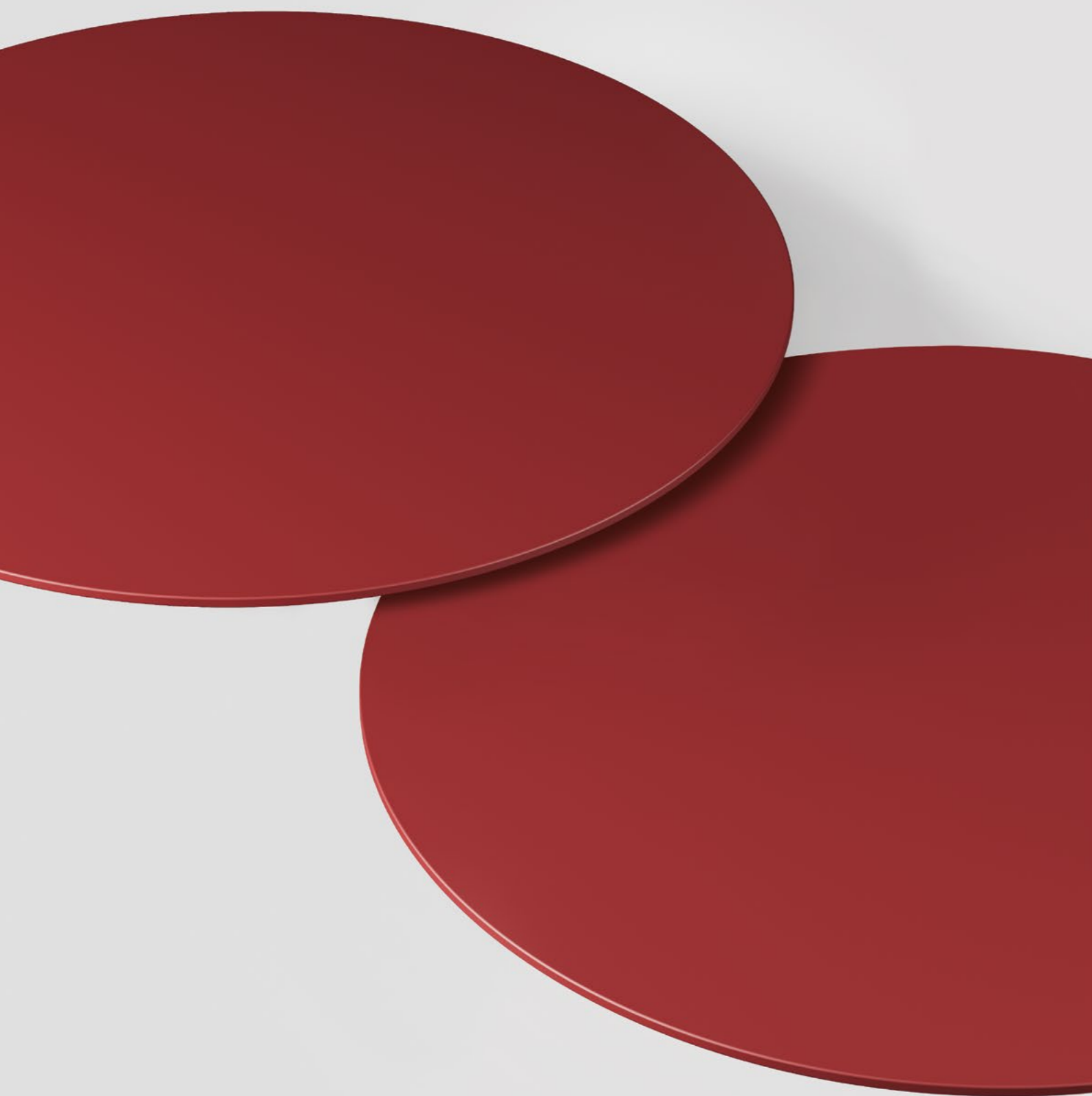











Grandes figuras geométricas aux formes essentielles qui se fondent presque dans l'architecture interne lorsqu'elles sont éteintes, pour révéler d'inattendues harmonies de lumière et d'ombres une fois éclairées. Les nouvelles finitions mates rendent les panneaux géométriques de *Puzzle Mega* plus chaleureux. Vernis liquides qui offrent de nouvelles possibilités décoratives en jouant avec les harmonies et les contrastes de couleurs et de formes. ● FR

Große geometrische Figuren in einfacher Form, die ausgeschaltet mit der Innenarchitektur verschmelzen, um eingeschaltet eine unerwartete Harmonie aus Licht und Schatten entstehen zu lassen. Neue matte Ausführungen erwärmen die geometrischen Paneele von *Puzzle Mega*. Flüssiglacke, die durch das Spiel mit Harmonien und Kontrasten von Farben und Formen neue dekorative Möglichkeiten eröffnen. ● DE

Grandes figuras geométricas con formas esenciales que casi se mezclan con la arquitectura interior cuando se apagan, para revelar inesperadas armonías de luz y sombras una vez encendidas. Nuevos acabados mate calientan los paneles geométricos de *Puzzle Mega*. Pinturas líquidas que brindan nuevas posibilidades decorativas jugando con armonías y contrastes de colores y formas. ● ES

Крупные геометрические фигуры с простыми строгими формами, которые почти полностью сливаются с архитектурой интерьера, когда они выключены. Но стоит их включить, как вы увидите неожиданную и гармоничную игру света и тени. Новые матовые отделки согревают геометрические панели *Puzzle Mega*. Жидкие эмали, открывающие новые декоративные возможности, играя с гармонией и контрастами цветов и форм. ● RU

该灯具具有大型几何图形的基本形状，关闭时，几乎与内部架构融为一体，一旦打开，会发现意想不到的光影和谐。全新哑光饰面为 *Puzzle Mega* 的几何面板带来温暖。液体涂料通过色彩和形状的和諧与对比开辟了新的装饰可能性。● ZH

Puzzle Mega round small ↘ Wall lamp

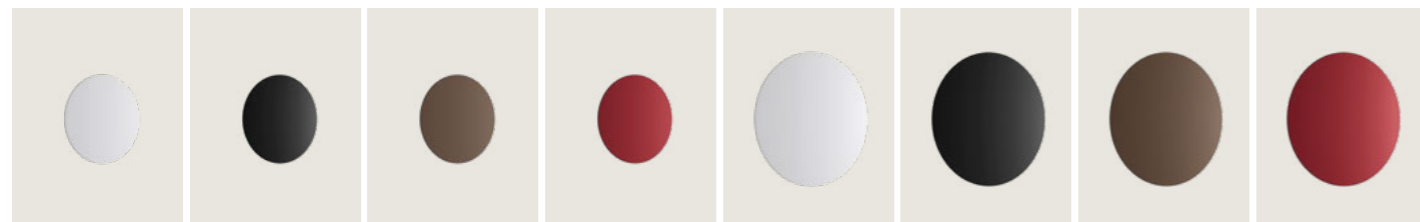

Puzzle Mega round large ↘ Wall lamp

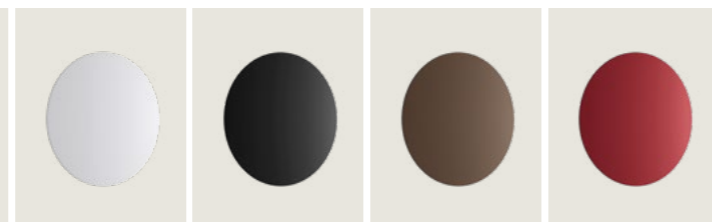

Puzzle Mega round small ↘ Ceiling lamp

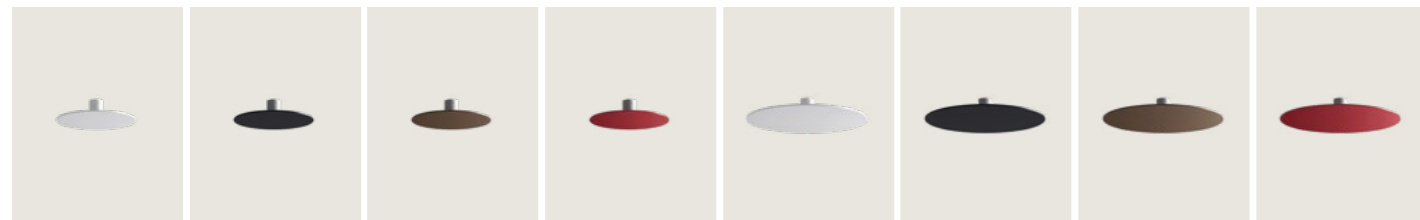

Puzzle Mega round large ↘ Ceiling lamp

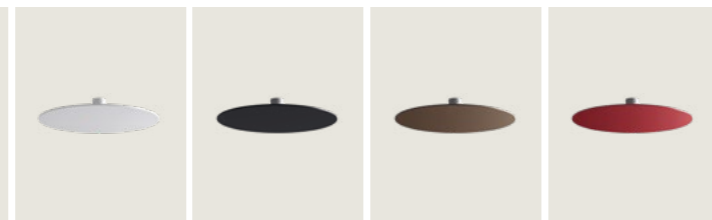

Puzzle Mega square small ↘ Wall lamp

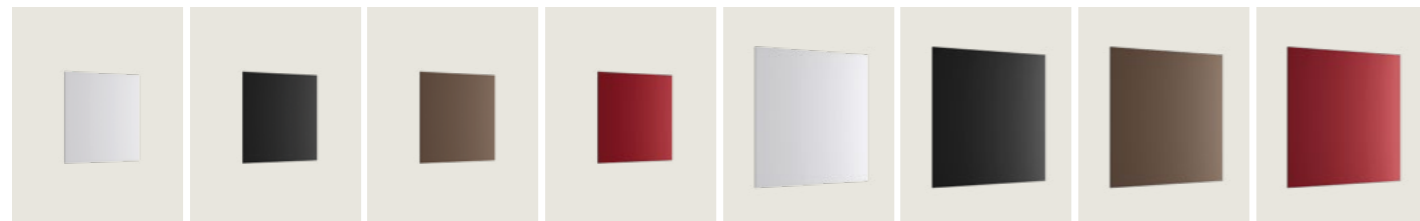

Puzzle Mega square large ↘ Wall lamp

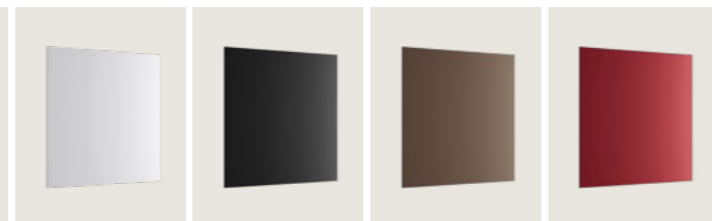

Puzzle Mega square small ↘ Ceiling lamp

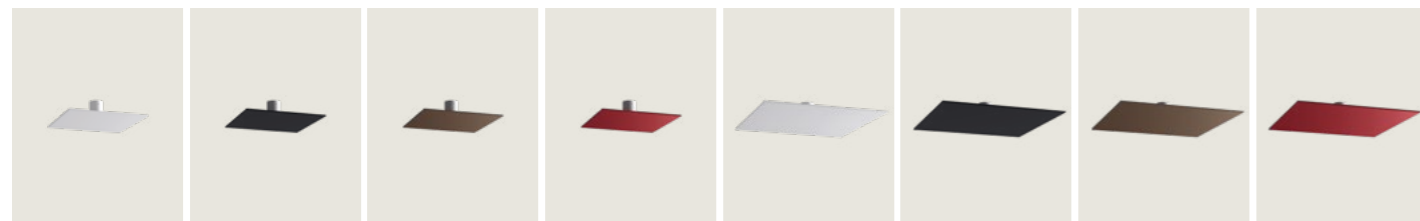

Puzzle Mega square large ↘ Ceiling lamp

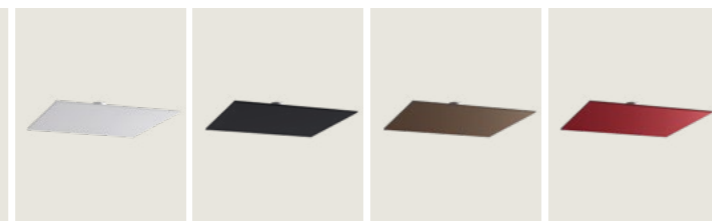

CATEGORY WALL LAMP CEILING LAMP

### Puzzle Mega round small

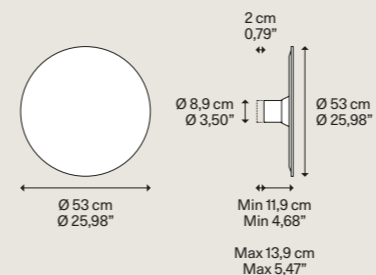

DESIGN Studio Italia Design, 2019

Metal structure  
Montatura in metallo

Matte White - 9016  
Bianco Opaco - 9016

Light source  
Sorgente luminosa

LED  
Turnable White  
25 W  
2700 K → 4590 lm  
3000 K → 4690 lm  
550 mA  
CRI 90  
MacAdam 3-Step  
LED and driver included  
LED e driver inclusi

Net weight Peso netto	3,80 kg 8,38 lbs	Pack Colli	2	Energy class Classe energetica	C
--------------------------	---------------------	---------------	---	-----------------------------------	---

MDF diffuser  
Diffusore in MDF

Matte White - 9016  
Bianco Opaco - 9016

Matte Black - 9005  
Nero Opaco - 9005

Taupe  
Grigio Caldo

Red  
Rosso

Code  
Codice

16746 1023

16746 2023

16746 3923

16746 6023

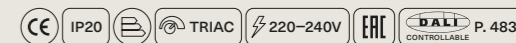

### Puzzle Mega round large

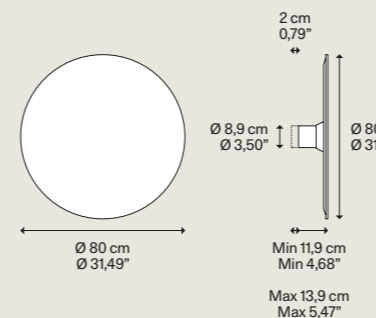

Metal structure  
Montatura in metallo

Matte White - 9016  
Bianco Opaco - 9016

Light source  
Sorgente luminosa

LED  
Turnable White  
33 W  
2700 K → 5980 lm  
3000 K → 6120 lm  
700 mA  
CRI 90  
MacAdam 3-Step  
LED and driver included  
LED e driver inclusi

Net weight Peso netto	7,20 kg 15,87 lbs	Pack Colli	2	Energy class Classe energetica	C
--------------------------	----------------------	---------------	---	-----------------------------------	---

MDF diffuser  
Diffusore in MDF

Matte White - 9016  
Bianco Opaco - 9016

Matte Black - 9005  
Nero Opaco - 9005

Taupe  
Grigio Caldo

Red  
Rosso

Code  
Codice

16748 1023

16748 2023

16748 3923

16748 6023

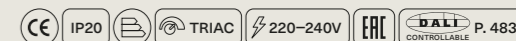

► LED sources with direct power supply to the AC line voltage – driver not required. Dimmable with phase cut dimmer. ► You can connect up to 4 Puzzle Mega to each fixture directly connected to the power supply. You can also connect up to 3 additional fixtures to each of those for maximum total of 36 fixtures on a single power outlet.

► LED con alimentazione diretta a tensione di rete – non necessita di driver. Dimmerabile con varialuce a taglio di fase. ► Ad ogni Puzzle Mega connessa al punto di alimentazione elettrica possono esserne collegate altre 4. Ad ognuna di queste possono esserne collegate fino ad altre 3 e così via. Le lampade totali collegabili su un singolo punto di alimentazione sono 36.



CATEGORY WALL LAMP CEILING LAMP

DESIGN Studio Italia Design, 2019

### Puzzle Mega square small

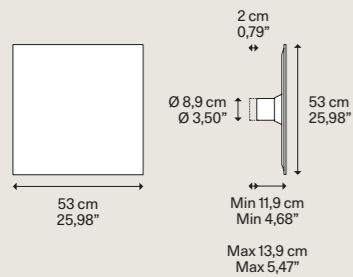

Metal structure  
Montatura in metallo

● Matte White - 9016  
Bianco Opaco - 9016

Light source  
Sorgente luminosa

LED  
Turnable White

25 W  
2700 K → 4590 lm  
3000 K → 4690 lm  
550 mA  
CRI 90  
MacAdam 3-Step

LED and driver included  
LED e driver inclusi

Net weight 4,10 kg  
Peso netto 9,04 lbs  
Pack 2  
Colli  
Energy class C  
Classe energetica

MDF diffuser  
Diffusore in MDF

● Matte White - 9016  
Bianco Opaco - 9016

● Matte Black - 9005  
Nero Opaco - 9005

● Taupe  
Grigio Caldo

● Red  
Rosso

Code  
Codice

16747 1023

16747 2023

16747 3923

16747 6023



### Puzzle Mega square large

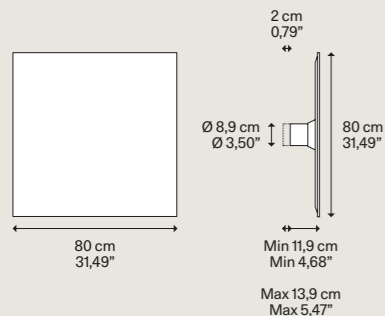

Metal structure  
Montatura in metallo

● Matte White - 9016  
Bianco Opaco - 9016

Light source  
Sorgente luminosa

LED  
Turnable White

33 W  
2700 K → 5980 lm  
3000 K → 6120 lm  
700 mA  
CRI 90  
MacAdam 3-Step

LED and driver included  
LED e driver inclusi

Net weight 8,80 kg  
Peso netto 19,40 lbs  
Pack 2  
Colli  
Energy class C  
Classe energetica

MDF diffuser  
Diffusore in MDF

● Matte White - 9016  
Bianco Opaco - 9016

● Matte Black - 9005  
Nero Opaco - 9005

● Taupe  
Grigio Caldo

● Red  
Rosso

Code  
Codice

16749 1023

16749 2023

16749 3923

16749 6023

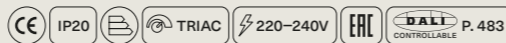

► LED sources with direct power supply to the AC line voltage - driver not required. Dimmable with phase cut dimmer. ► You can connect up to 4 Puzzle Mega to each fixture directly connected to the power supply. You can also connect up to 3 additional fixtures to each of those for maximum total of 36 fixtures on a single power outlet.

► LED con alimentazione diretta a tensione di rete - non necessita di driver. Dimmerabile con varialuce a taglio di fase. ► Ad ogni Puzzle Mega connessa al punto di alimentazione elettrica possono esserne collegate altre 4. Ad ognuna di queste possono esserne collegate fino ad altre 3 e così via. Le lampade totali collegabili su un singolo punto di alimentazione sono 36.

CATEGORY ACCESSORY

DESIGN Studio Italia Design, 2019

### Puzzle Mega extension

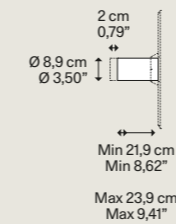

Net weight 0,86 kg  
Peso netto 1,86 lbs  
Pack 1  
Colli

Description  
Descrizione

Extension optional ► to be used to widen the light beam in case of ceiling installation

Estensione opzionale ► da utilizzare per ampliare il fascio luminoso in caso di installazione a soffitto

Metal structure  
Montatura in metallo

● Matte White - 9016  
Bianco Opaco - 9016

Code  
Codice

16799 A200



Puzzle Mega standard version  
Puzzle Mega versione standard

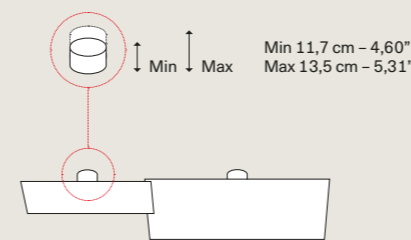

Puzzle Mega extension optional version  
Puzzle Mega versione estensione opzionale

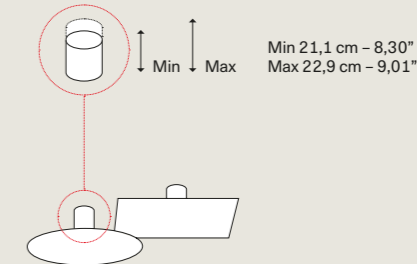

### Accessory connector



Net weight 0,10 kg  
Peso netto 0,22 lbs  
Pack 1  
Colli

Description  
Descrizione

Connection ► to be used to connect the fixtures together in the compositions  
Collegamento ► da utilizzare per collegare le lampade tra loro nelle composizioni

Code  
Codice

16799 A100



Accessory connector  
Accessorio di collegamento

Main power connection

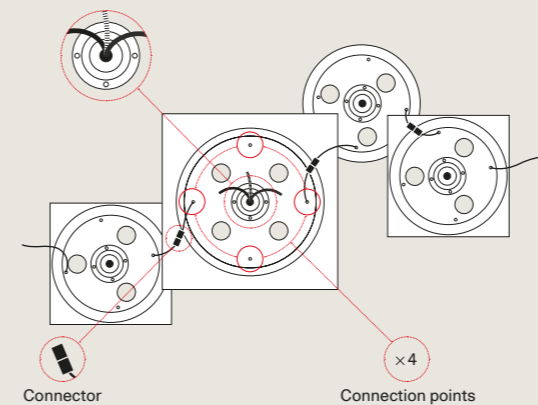



# Bugia

Designed by Andrea Tosetto

Year 2016, 2020

Round, compact forms featuring elegant finishes with a centre that shines like a precious stone. Once lit up, *Bugia* amazes with the unexpected effect of its light. A surprising and harmonious balance between direct and indirect light, diffused both downward and up toward the ceiling. A rich family of ceiling lights, in *Single*, *Double*, *Triple* and *Mega* versions.

Forme rotonde compatte dalle finiture raffinate con un centro che splende come una pietra preziosa. Appena viene accesa, *Bugia* sorprende per l'effetto inaspettato della sua luce. Un inaspettato equilibrio armonico tra luce diretta e indiretta, diffusa sia verso il basso che verso il soffitto. Una ricca famiglia di plafoniere, in versione *Single*, *Double*, *Triple* e *Mega*.



Go to the technical info [+](#) Click to discover more [↓](#)

Bugia COD. 161	CATEGORY LAMP		TYPE OF LIGHT	
	Ceiling	Soffitto	Symmetrical diffused light	Luce simmetrica diffusa
				







Forme ronde compacte aux finitions raffinées avec un point central qui brille comme une pierre précieuse. Une fois allumée, *Bugia* surprend par l'effet inattendu de sa lumière. Un harmonieux équilibre inattendu entre lumière directe et indirecte, diffusée vers le bas ou vers le plafond. Une riche famille de plafonniers, en version *Single*, *Double*, *Triple* et *Mega*. ●FR

Kompakte, runde Formen mit raffinierten Ausführungen und einem Mittelpunkt, der wie ein Edelstein funkelt. Beim Einschalten überrascht *Bugia* durch den unerwarteten Effekt ihres Lichts. Ein unerwartet harmonisches Gleichgewicht zwischen direktem und indirektem Licht, das sowohl nach unten wie auch zur Decke gestrahlt wird. Eine ganze Familie von Deckenleuchten, in *Single*-, *Double*-, *Triple*- und *Mega*-Versionen. ●DE

Formas redondas compactas con acabados refinados con un centro que brilla como una piedra preciosa. Tan pronto como se enciende, *Bugia* sorprende con el inesperado efecto de su luz. Un inesperado equilibrio armónico entre la luz directa e indirecta, difusa tanto hacia abajo como hacia el techo. Una rica familia de lámparas de techo, en versiones *Single*, *Double*, *Triple* y *Mega*. ●ES

Компактные круглые формы с изысканной отделкой, в центре которых как бы сияет драгоценный камень. Сразу же при включении светильник *Bugia* поражает своим потрясающим световым эффектом. Неожиданно уравновешенная гармония между прямым и непрямым светом, распространяющимся как вниз, так и к потолку. Богатая семья плафонов в вариации *Single*, *Double*, *Triple* и *Mega*. ●RU

*Bugia*圆形灯,紧凑的形状有着优雅的饰面,其中心部分犹如宝石一般闪耀。一经点亮,*Bugia*就会以其意想不到的灯光效果而惊艳众生。直射照明与间接照明之间有着令人惊叹的和谐平衡,向下扩散的同时亦可向上漫射至天花板。它是一款丰富多样的吸顶灯系列,有单灯、双灯、三灯和*Mega*巨型版本。●ZH

Bugia Single ▾ Ceiling lamp

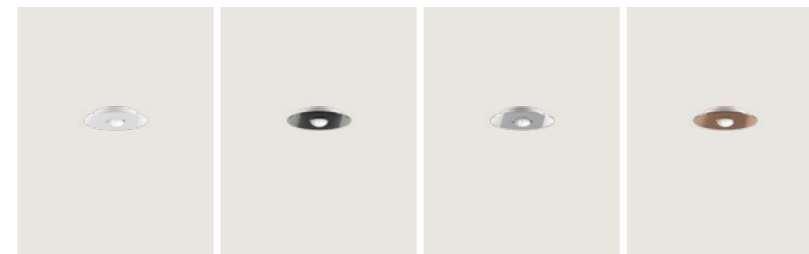

Bugia Double ▾ Ceiling lamp



Bugia Triple ▾ Ceiling lamp



Bugia Mega ▾ Ceiling lamp

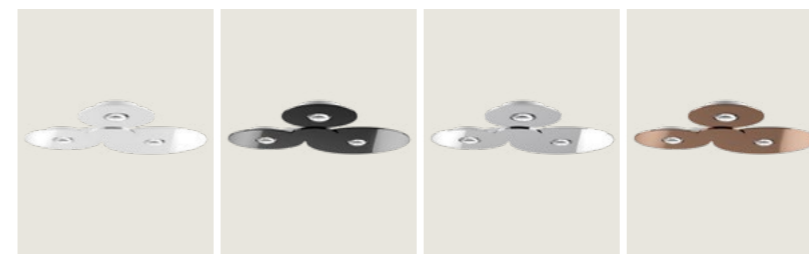

## CATEGORY CEILING LAMP

DESIGN Andrea Tosetto, 2016

## Bugia Single

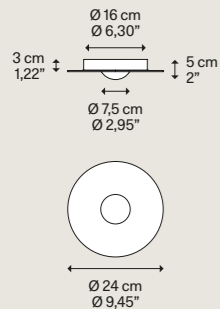
Metal structure  
Montatura in metallo

● Matte White - 9010  
Bianco Opaco - 9010

Light source  
Sorgente luminosa

AC LED  
2700 K  
15 W  
1320 lm  
220-240 V  
CRI 90  
MacAdam 3-Step

LED included  
LED inclusoMethacrylate diffuser  
Diffusore in metacrilato

● Glossy White  
Bianco Lucido

● Glossy Black  
Nero Lucido

● Chrome  
Cromo

● Glossy Bronze  
Bronzo Lucido

Code  
Codice

A

Code  
Codice

B

16131 1227 16131 1230

16131 2227 16131 2230

16131 4027 16131 4030

16131 4627 16131 4630

Light source  
Sorgente luminosa

AC LED  
3000 K  
15 W  
1440 lm  
220-240 V  
CRI 90  
MacAdam 3-Step

LED included  
LED incluso

Net weight 0,80 kg  
Peso netto 1,76 lbs  
Pack Colli 2  
Energy class Classe energetica F

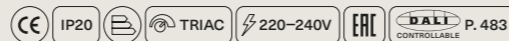

## CATEGORY CEILING LAMP

DESIGN Andrea Tosetto, 2016

## Bugia Triple

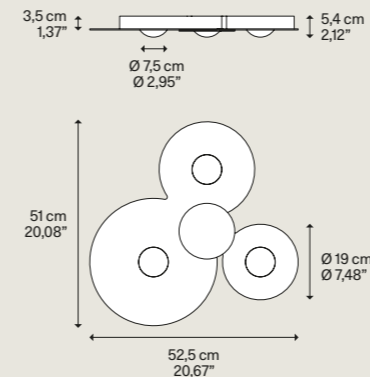
Metal structure  
Montatura in metallo

● Matte White - 9010  
Bianco Opaco - 9010

Light source  
Sorgente luminosa

AC LED  
2700 K  
3x 15 W  
3960 lm  
220-240 V  
CRI 90  
MacAdam 3-Step

LED included  
LED inclusoMethacrylate diffuser  
Diffusore in metacrilato

● Glossy White  
Bianco Lucido

● Glossy Black  
Nero Lucido

● Chrome  
Cromo

● Glossy Bronze  
Bronzo Lucido

Code  
Codice

A

Code  
Codice

B

16133 1227 16133 1230

16133 2227 16133 2230

16133 4027 16133 4030

16133 4627 16133 4630

Light source  
Sorgente luminosa

AC LED  
3000 K  
3x 15 W  
4320 lm  
220-240 V  
CRI 90  
MacAdam 3-Step

LED included  
LED incluso

Net weight 2,80 kg  
Peso netto 6,17 lbs  
Pack Colli 2  
Energy class Classe energetica F

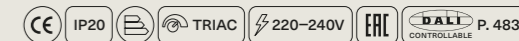

## Bugia Double

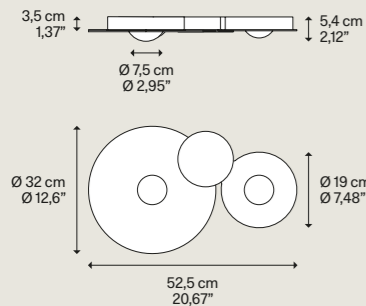
Metal structure  
Montatura in metallo

● Matte White - 9010  
Bianco Opaco - 9010

Light source  
Sorgente luminosa

AC LED  
2700 K  
2x 15 W  
2640 lm  
220-240 V  
CRI 90  
MacAdam 3-Step

LED included  
LED inclusoMethacrylate diffuser  
Diffusore in metacrilato

● Glossy White  
Bianco Lucido

● Glossy Black  
Nero Lucido

● Chrome  
Cromo

● Glossy Bronze  
Bronzo Lucido

Code  
Codice

A

Code  
Codice

B

16132 1227 16132 1230

16132 2227 16132 2230

16132 4027 16132 4030

16132 4627 16132 4630

Light source  
Sorgente luminosa

AC LED  
3000 K  
2x 15 W  
2880 lm  
220-240 V  
CRI 90  
MacAdam 3-Step

LED included  
LED incluso

Net weight 2,05 kg  
Peso netto 4,52 lbs  
Pack Colli 2  
Energy class Classe energetica F

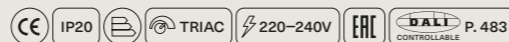

## CATEGORY CEILING LAMP

DESIGN Andrea Tosetto, 2020

## Bugia Mega

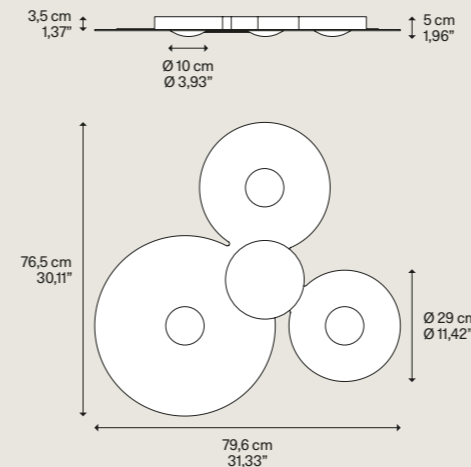
Metal structure  
Montatura in metallo

● Matte White - 9010  
Bianco Opaco - 9010

Light source  
Sorgente luminosa

AC LED  
2700 K  
3x 15 W  
3960 lm  
220-240 V  
CRI 90  
MacAdam 3-Step

LED included  
LED inclusoMethacrylate diffuser  
Diffusore in metacrilato

● Glossy White  
Bianco Lucido

● Glossy Black  
Nero Lucido

● Chrome  
Cromo

● Glossy Bronze  
Bronzo Lucido

Code  
Codice

A

Code  
Codice

B

16134 1227 16134 1230

16134 2227 16134 2230

16134 4027 16134 4030

16134 4627 16134 4630

Light source  
Sorgente luminosa

AC LED  
3000 K  
3x 15 W  
4320 lm  
220-240 V  
CRI 90  
MacAdam 3-Step

LED included  
LED incluso

Net weight 4,40 kg  
Peso netto 9,70 lbs  
Pack Colli 2  
Energy class Classe energetica F

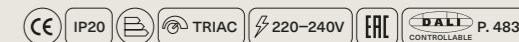

► LED sources with direct power supply to the AC line voltage – driver not required.  
Dimmable with phase cut dimmer.

► LED con alimentazione diretta a tensione di rete – non necessita di driver.  
Dimmerabile con varialuce a taglio di fase.

► LED sources with direct power supply to the AC line voltage – driver not required.  
Dimmable with phase cut dimmer.

► LED con alimentazione diretta a tensione di rete – non necessita di driver.  
Dimmerabile con varialuce a taglio di fase.



# Pin-Up

Designed by Andrea Toso

Year 2015

A striking, compact light with a simple, organic design, *Pin-Up* opens like a shell to provide a bright light and the quality of LED lighting. A light that can be modelled at will thanks to the flexibility of the light fixture and the availability of two LED sources.

Una lampada compatta e sorprendente, dal design essenziale ed organico, *Pin-Up* si schiude come una conchiglia per illuminare gli spazi con la decisione e la qualità della luce a LED. Una luce che può essere modellata a piacere grazie alla flessibilità della lampada e alla disponibilità di due sorgenti LED.



Go to the technical info [+](#) Click to discover more [↓](#)

Pin-Up COD. 155	CATEGORY LAMP		TYPE OF LIGHT	
	Wall Ceiling	Parete Soffitto	Symmetrical diffused light Adjustable light	Luce simmetrica diffusa Luce orientabile





Lampe compacte et surprenante, au design essentiel et organique, *Pin-Up* s'ouvre comme une coquille pour éclairer les espaces avec la précision et la qualité de la lumière LED. Une lumière qui peut être modelée à souhait grâce à la flexibilité de la lampe et à la disponibilité de deux sources LED. ●FR

Als eine kompakte und überraschende Lampe mit klarem, organischem Design schließt sich *Pin-Up* wie eine Muschel, um Räume mit der Entschlossenheit und Qualität von LED-Licht zu erhellen. Ein Licht, das dank der Flexibilität der Lampe und des Vorhandenseins von zwei LED-Quellen verändert werden kann. ●DE

Una lámpara compacta y sorprendente, de diseño esencial y orgánico, *Pin-Up* se abre como una concha para iluminar los espacios con la decisión y la calidad de la luz de LED. Una luz que puede ser modelada a gusto gracias a la flexibilidad de la lámpara y a la disponibilidad de dos fuentes de LED. ●ES

*Pin-Up* - изумительный компактный светильник со сдержанным, органичным дизайном. Открывается как ракушка и смело освещает пространство качественным светодиодным светом. Превосходная гибкость и наличие двух светодиодных источников позволяют моделировать освещение по желанию. ●RU

*Pin-Up* 是一款紧凑而令人惊喜的灯具，设计简洁有序，如一个贝壳打开，以坚定而优质的LED灯光照亮空间。灯身灵活，配有两盏LED光源，灯光可随喜好调节。●ZH

CATEGORY WALL LAMP CEILING LAMP

## Pin-Up

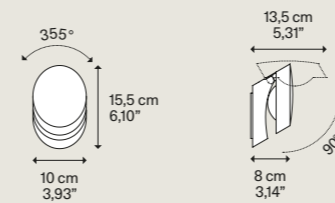

DESIGN Andrea Tosetto, 2015

Metal structure  
Montatura in metallo

● Matte White - 9010  
Bianco Opaco - 9010

● Matte Black - 9005  
Nero Opaco - 9005

● Coppery Bronze  
Bronzo Ramato

Code  
Codice ●A

15540 1027 15540 1030

15540 2027 15540 2030

15540 3527 15540 3530

Light source  
Sorgente luminosa ●A

AC LED  
2700 K  
8 W  
920 lm  
220-240 V  
CRI 92  
MacAdam 3-Step

LED included  
LED incluso

Light source  
Sorgente luminosa ●B

AC LED  
3000 K  
8 W  
980 lm  
220-240 V  
CRI 92  
MacAdam 3-Step

LED included  
LED incluso

Net weight 1,15 kg Pack 1  
Peso netto 2,53 lbs Colli 1  
Energy class E  
Classe energetica E

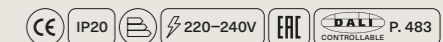

Adjustable light  
Luce orientabile



Pin-Up ▾ Wall lamp, Ceiling lamp

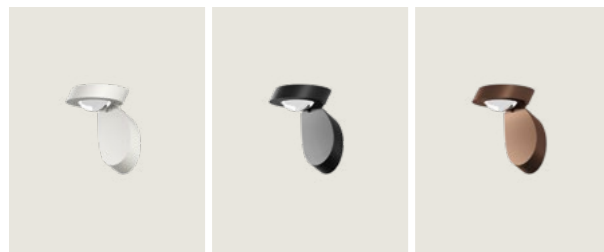

► LED sources with direct power supply to the AC line voltage - driver not required. ► LED con alimentazione diretta a tensione di rete - non necessita di driver.

# Laser

Designed by Studio Italia Design

Year 2015

*Laser* is a compact, versatile light fixture in the shape of a box with an attractive architectural look. From its painted steel structure, available in one size and three different finishes, now including Champagne, the LED light source diffuses a functional and evocative two-way light that creates plays of light and shadow on the wall.

*Laser* è una lampada compatta a forma di parallelepipedo dal carattere versatile e architettonico. Dalla sua struttura in acciaio verniciato, disponibile in una dimensione e in tre diverse finiture, ora anche Champagne, la sorgente a LED diffonde una luce bidirezionale funzionale e d'effetto che crea giochi di luce ed ombra sulla parete.

[Go to the technical info](#) 

[Click to discover more](#) 

Laser  
COD. 036

CATEGORY LAMP

Wall Parete

TYPE OF LIGHT

Symmetrical diffused light Luce simmetrica diffusa







*Laser* est une lampe compacte en forme de parallélépipède au caractère polyvalent et architectural. De sa structure en acier peint, disponible en taille unique et en trois finitions différentes, y compris le Champagne, la source LED diffuse une lumière bidirectionnelle fonctionnelle et efficace qui crée des jeux d'ombre et de lumière sur le mur. ●FR

*Laser* ist eine kompakte Lampe in Form eines Parallelepipedes mit vielseitigem und architektonischem Charakter. Durch seine Armatur aus lackiertem Stahl, die in einer Größe und drei unterschiedlichen Ausführungen - jetzt auch Champagner - verfügbar ist, verbreitet die LED-Lichtquelle bidirektionales, funktionelles sowie effektvolles Licht, wodurch ein Spiel aus Licht und Schatten an der Wand entsteht. ●DE

*Laser* es una lámpara compacta con forma de paralelepípedo con carácter versátil y arquitectónico. De su estructura de acero pintado, disponible en una dimensión y en tres diferentes acabados, ahora incluyendo Champán, la fuente de LED difunde una luz bidireccional funcional y con efecto que crea juegos de luz y sombra en la pared. ●ES

*Laser* – компактный светильник в форме параллелепипеда с многогранным архитектурным характером. Конструкция светильника выполнена из окрашенной стали, доступной в двух размерах и трех различных вариантах отделки. Светодиодный источник эффективно рассеивает двунаправленный свет, создающий на стене игру света и тени. ●RU

*Laser*是一款四边形的紧凑灯具，具有建筑美感，广泛适用。喷漆钢材的结构，有一种尺寸和三种不同的颜色，如今还有香槟色，LED光源散发着双向的功能灯光，在墙壁上形成光影效果。●ZH

CATEGORY WALL LAMP

Laser



DESIGN Studio Italia Design, 2015

Metal structure  
Montatura in metallo

● Matte White – 9010 Bianco Opaco – 9010	Code Codice <b>A</b> 03652 1027	Code Codice <b>B</b> 03652 1030
● Matte Black – 9005 Nero Opaco – 9005	03652 2027	03652 2030
● Champagne Champagne	03652 4527	03652 4530

Light source  
Sorgente luminosa **A**

AC LED  
2700 K  
16 W  
1750 lm  
220–240 V  
CRI 92  
MacAdam 3-Step

LED included  
LED incluso

Light source  
Sorgente luminosa **B**

AC LED  
3000 K  
16 W  
1850 lm  
220–240 V  
CRI 92  
MacAdam 3-Step

LED included  
LED incluso

Net weight Peso netto	0,60 kg 1,32 lbs	Pack Colli	1	Energy class Classe energetica	E
--------------------------	---------------------	---------------	---	-----------------------------------	---

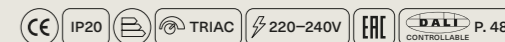

Laser ▾ Wall lamp

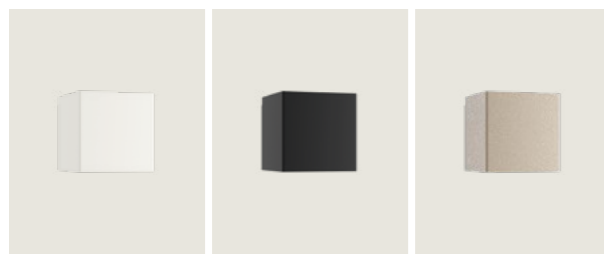

► LED sources with direct power supply to the AC line voltage – driver not required. Dimmable with phase cut dimmer.

► LED con alimentazione diretta a tensione di rete – non necessita di driver. Dimmerabile con varialuce a taglio di fase.



# Aile

Designed by Luca Nichetto

Year 2021

The *Aile* aluminium wall lamp features a simple and dynamic design reminiscing the aileron of sport cars, after which it has been named. *Aile's* compact size, sleek design, powerful light output with respect to its dimensions and two finishes offer a complete lighting solution even for more intimate settings.

*Aile*, lampada da parete in alluminio, presenta un design semplice e dinamico, proprio come l'alettone delle auto sportive, aileron in inglese, da cui prende il nome. La compattezza, il design elegante, la forte capacità di emissione di luce rispetto alle dimensioni e le due finiture rendono *Aile* una soluzione perfetta anche per illuminare ambienti raccolti.

Go to the technical info 

Click to discover more 

Aile  
COD. 175

CATEGORY LAMP

Wall Parete

TYPE OF LIGHT

Symmetrical diffused light Luce simmetrica diffusa

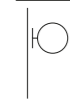

Aile, FINISH Matte White.



Aile, FINISH Champagne.



Aile, FINISH Matte Black.

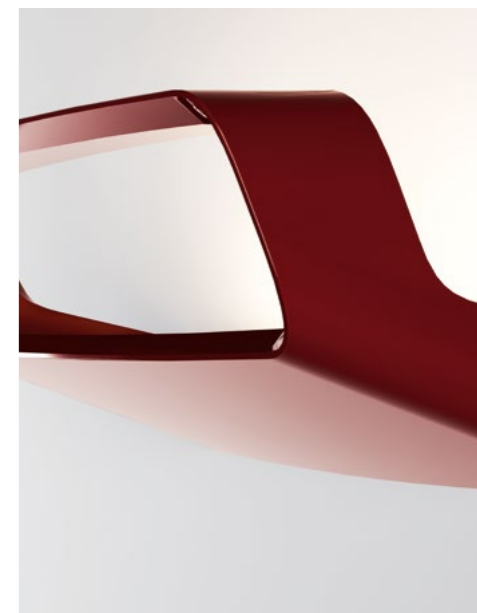

Aile, FINISH Lacquer Red.



Légère applique en aluminium, *Aile* présente un design simple et dynamique rappelant l'aileron d'une voiture de sport dont le nom s'inspire. La taille compacte d'*Aile*, son design élégant, son rayonnement lumineux puissant par rapport aux dimensions et ses deux finitions offrent une solution d'éclairage complète, même pour des espaces plus intimes. ● FR

Die *Aile* Aluminium-Wandleuchte zeichnet sich durch ein schlichtes und dynamisches Design aus, das an das Querruder eines Sportwagens erinnert – aileron auf Englisch, nach dem sie benannt wurde. Die Kompaktheit, das elegante Design und die starke Lichtleistung im Vergleich zu ihrer Größe sowie die zwei Ausführungen machen *Aile* zu einer perfekten Beleuchtungslösung sogar für intimere Umgebungen. ● DE

*Aile*, lámpara de pared de aluminio, presenta un diseño sencillo y dinámico, igual que el alerón de los coches deportivos, aileron en inglés, del que toma su nombre. El tamaño compacto, el diseño elegante, la potente emisión de luz con respecto a su tamaño y los dos acabados, hacen que *Aile* sea una solución perfecta incluso para iluminar entornos íntimos. ● ES

Новая настенная алюминиевая лампа *Aile* отличается простым дизайном и динамичной формой, напоминающей элероны спортивных автомобилей, «aileron» на английском, в честь которых она и получила свое название. Компактный размер, элегантный дизайн, мощная светоотдача, по сравнению с ее размерами, а также четыре варианта богатой отделки делают из *Aile* идеальное решение также для освещения более интимных уголков. ● RU

*Aile* 铝制壁灯拥有简约大方且与动感十足的设计, 令人联想至跑车的副翼, 从而以此得名。 *Aile* 紧凑的尺寸、时尚的设计、相对其尺寸的强大光线输出以及两款饰面, 为更多甚为私密的环境设置提供了一项完整的照明解决方案。 ● ZH

CATEGORY WALL LAMP

## Aile

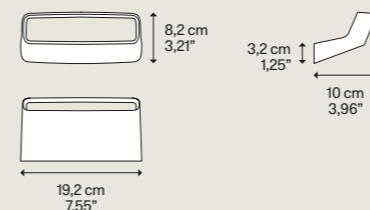

DESIGN Luca Nichetto, 2021

Metal structure  
Montatura in metallo

● Matte White – 9010  
Bianco Opaco – 9010

● Matte Black – 9005  
Nero Opaco – 9005

● Champagne  
Champagne

● Lacquer Red  
Rosso Lacca

Code  
Codice

A

Code  
Codice

B

17550 1027

17550 1030

17550 2027

17550 2030

17550 4527

17550 4530

17550 6027

17550 6030

Light source  
Sorgente luminosa

A

AC LED  
2700 K  
2× 8 W  
1840 lm  
220–240 V  
CRI 92  
MacAdam 3-Step

LED included  
LED incluso

Light source  
Sorgente luminosa

B

AC LED  
3000 K  
2× 8 W  
1960 lm  
220–240 V  
CRI 92  
MacAdam 3-Step

LED included  
LED incluso

Net weight	0,55 kg	Pack	1	Energy class	E
Peso netto	1,21 lbs	Colli		Classe energetica	

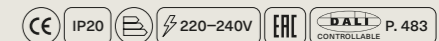

Aile ▾ Wall lamp

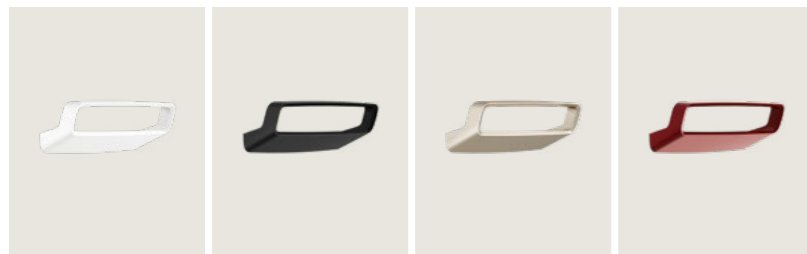

► LED sources with direct power supply to the AC line voltage – driver not required. ► LED con alimentazione diretta a tensione di rete – non necessita di driver.

## Customised *Lighting Solutions*

In *Lodes*, we continue exploring the intimate connection between our products and the people who choose them, as well as the interaction between the lamps and the environments furnished with our lights. When design requirements call for elevating the standard idea of made-to-measure, our concept, called *Out of Scale*, comes into play. The possibilities are endless, with fully personalised *configurations* of unprecedented shapes and sizes. *Lodes* can meet the needs of any design space and decor with *impactful lighting arrangements*. *Light compositions* become even more tailored solutions to address any challenge, providing a unique and personal lighting design.

In *Lodes* continuiamo ad esplorare l'intimo legame tra i nostri prodotti e le persone che li scelgono, l'interazione tra le lampade e gli ambienti arredati con le nostre luci. Quando le esigenze progettuali richiedono di elevare l'idea standard del "su misura", il nostro concetto, chiamato fuori scala, entra in gioco. L'*Out of Scale* è una soluzione totalmente su misura in cui le possibilità sono infinite e le soluzioni sono interamente personalizzate sviluppando *configurazioni* di forma e dimensione senza precedenti. *Lodes* è in grado di soddisfare le esigenze di qualsiasi spazio e arredo progettuale. Le *composizioni di luce* diventano ancor più risposte personalizzate per risolvere qualsiasi criticità, per arredare ogni ambiente con una *scenografia luminosa* unica e personale.

# Customised *Lighting Solutions*

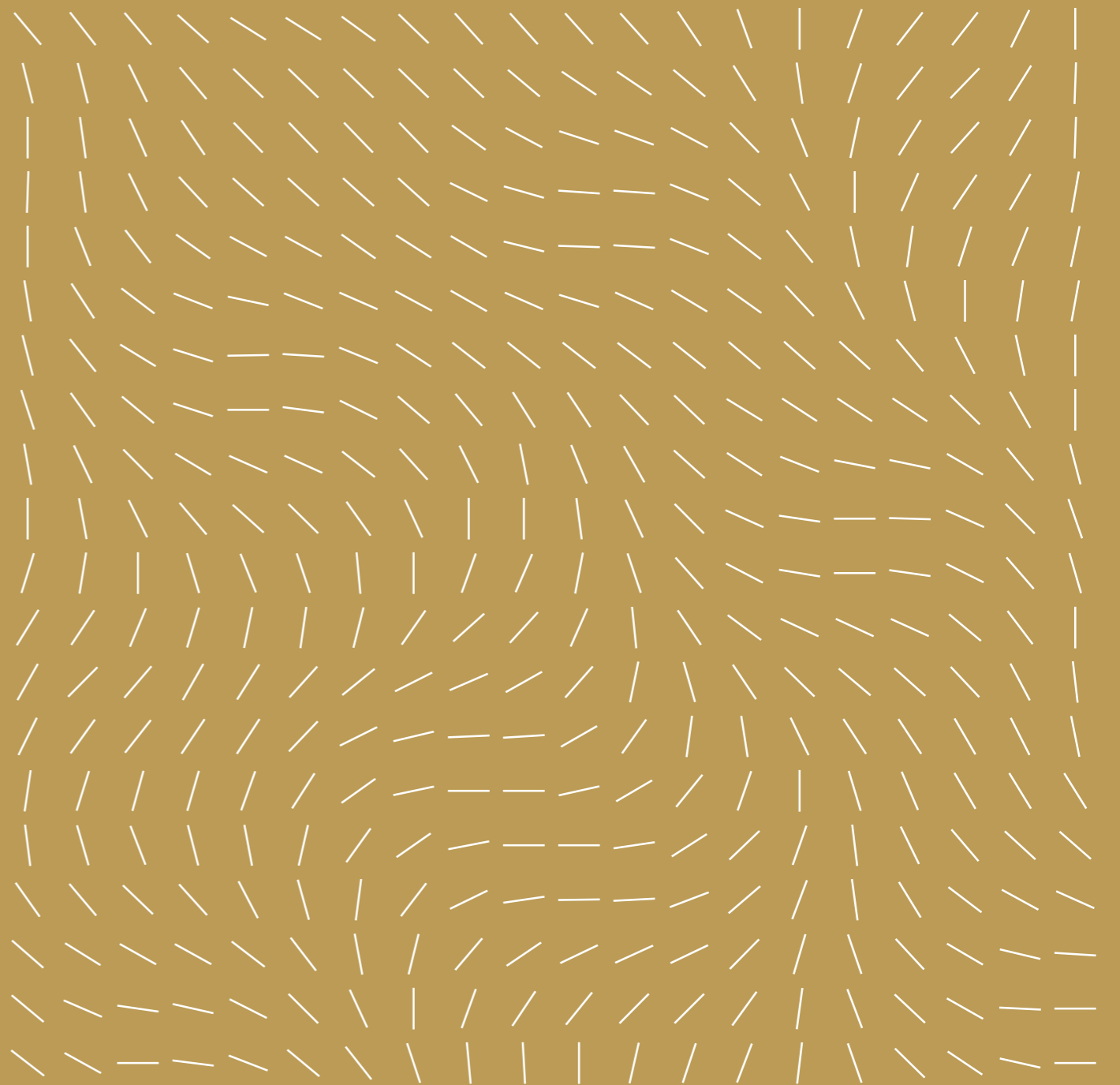



## The Case Studies Series

The *Lodes* Case Studies Series aims to showcase concrete examples of the concepts of *Standard Bespoke* and *Out of Scale* in action, demonstrating how, starting from a problem and a design requirement, a solution can be achieved to meet the unique spatial and design needs. It's possible to combine *Lodes'* range of products and canopies to create distinctive and meaningful compositions, that can be tailored to individual preferences.

L'intento di *Lodes* Case Studies Series è quello di porre enfasi su esempi concreti di applicazione dei concetti di *Standard Bespoke* e *Out of Scale*, evidenziando come, partendo da un problema e da un'esigenza progettuale si sia potuti arrivare ad una soluzione capace di rispondere alle esigenze uniche dello spazio e del progetto, attraverso la creazione di composizioni distintive e significative, su misura per le preferenze individuali, combinando in modo funzionale la gamma di prodotti e rosoni *Lodes*.

## Kempinski Hotel San Lawrenz, Gozo – Malta

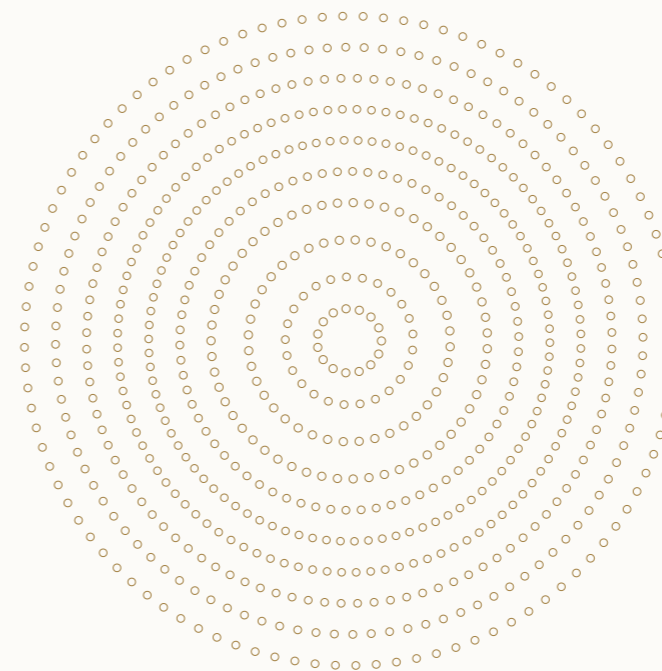
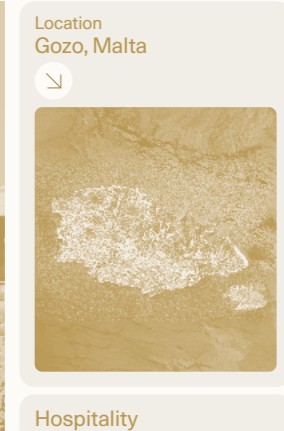

The first case study in this series features the *Kempinski Hotel San Lawrenz* in Gozo, Malta. A luminous dome composed of 868 A-Tube Nano fixtures. A cascade of light with striking scenic impact that needed to harmonise with the natural light filtering through a circular glass skylight to which the composition was anchored.

Il primo caso di studio di questa serie è l'*Hotel Kempinski San Lawrenz* a Gozo, Malta. Una cupola luminosa composta da 868 A-Tube Nano. Una cascata di luce, di grande impatto scenografico, che doveva dialogare con la luce che naturalmente filtrava da un lucernario circolare in vetro al quale la composizione si ancorava.

Lodes Projects  
Discover our Projects





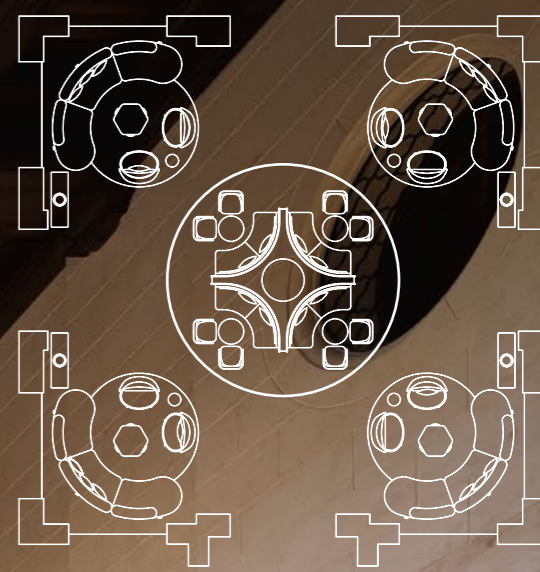



Massimiliano Tosetto explains:  
 “With this requirement, we had to *create something that had never been done before*. A structure capable of supporting the composition, housing as many as 864 drivers inside it plus 4 drivers placed on the central element at the top, all while allowing natural light to filter through from the ceiling.”

Massimiliano Tosetto, racconta:  
 “Con questo requisito, *abbiamo dovuto creare qualcosa che non era mai stato fatto prima*. Una struttura capace di sostenere la composizione, alloggiando al suo interno ben 864 driver più 4 driver posti sull’elemento centrale in alto, che doveva al tempo stesso permettere alla luce naturale di filtrare dal soffitto.”

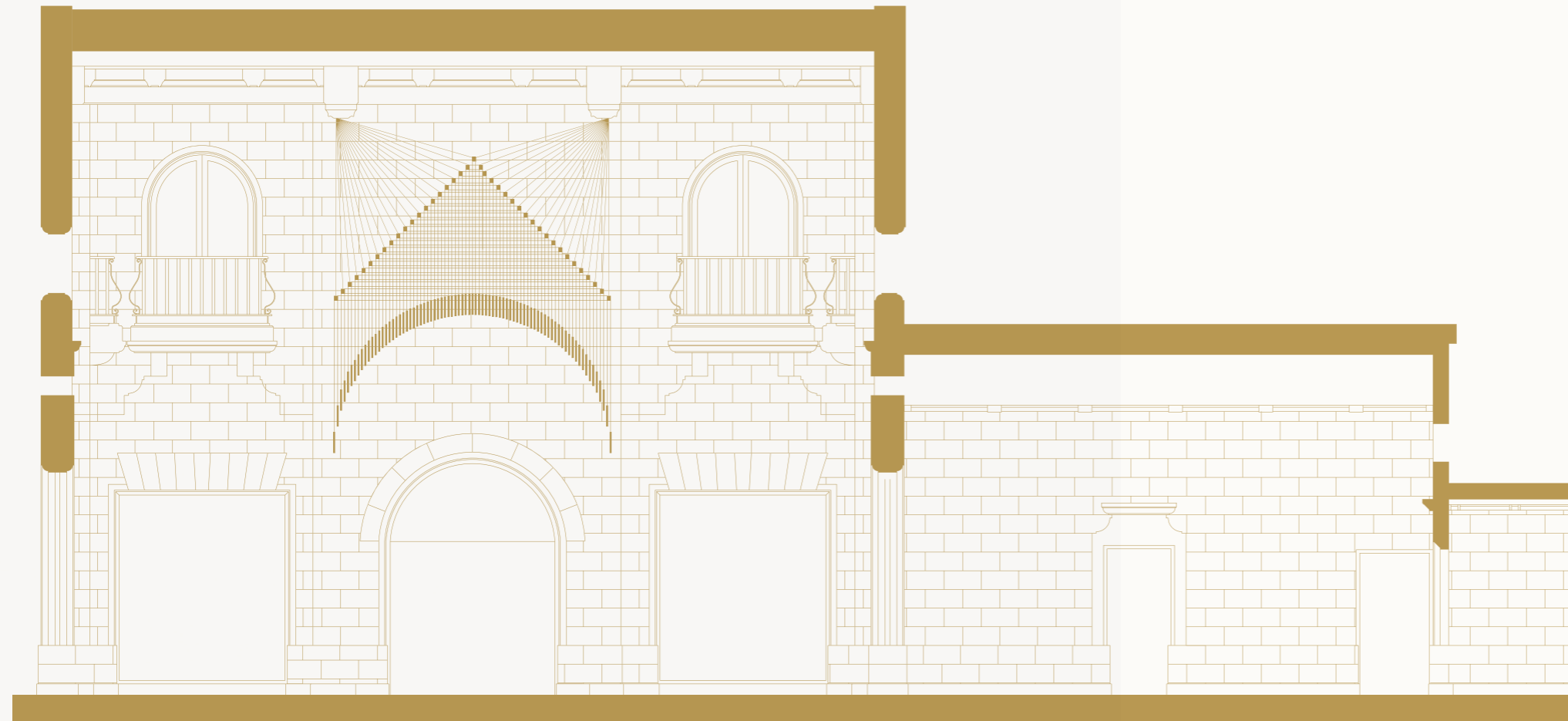

Front view of the architectural project by the Swedish studio Living Design, which oversaw the entire interior design project.

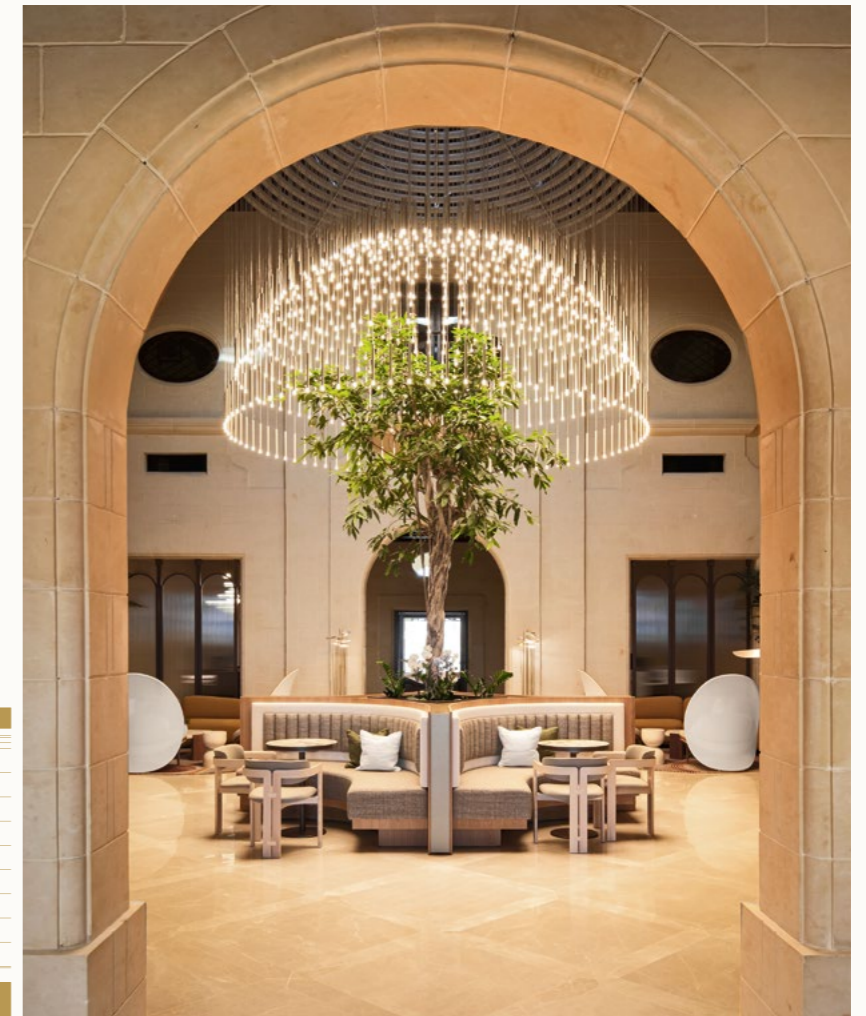

Product  
 A-Tube Nano large

Request  
 Special composition in a hall – Anchored to the skylight with the ability to allow natural light to filter through

Arrangement  
 Dome-shaped composition

Type of canopy  
 Custom-made metal conical canopy composed of 20 rings

Quantity of lamps	Composition height	Diameter
868 pcs	4,8 m	4 m

In the design phase, we focused on finding a structure that balanced structural rigidity, low weight, and transparency. We determined that a *conical structure* would be ideal to achieve the effect the customer wanted. The ring structure was engineered in segmented sections to facilitate transport and installation.

Our service encompassed *comprehensive support*, from design assistance to the development of a customised structure, plus, of course, the supply of the lamps. Additionally, we provided on-site installation assistance for this project.

A livello di progettazione, si è prima cercato di capire quale tipo di struttura potesse dare il giusto compromesso tra rigidità strutturale, peso ridotto e trasparenza; per arrivare poi a determinare che una *struttura conica* era l’ideale per ottenere l’effetto desiderato dal cliente. La struttura ad anelli è stata progettata con segmenti divisi in sezioni per facilitare il trasporto e l’installazione.

Il servizio che abbiamo offerto è stato *completo*, dal supporto progettuale allo sviluppo di una struttura custom, oltre a, naturalmente, le lampade. E per questo progetto abbiamo anche fornito l’assistenza in loco per l’installazione.

# Case Studies Series – Chapter I

Kempinski Hotel  
View the video

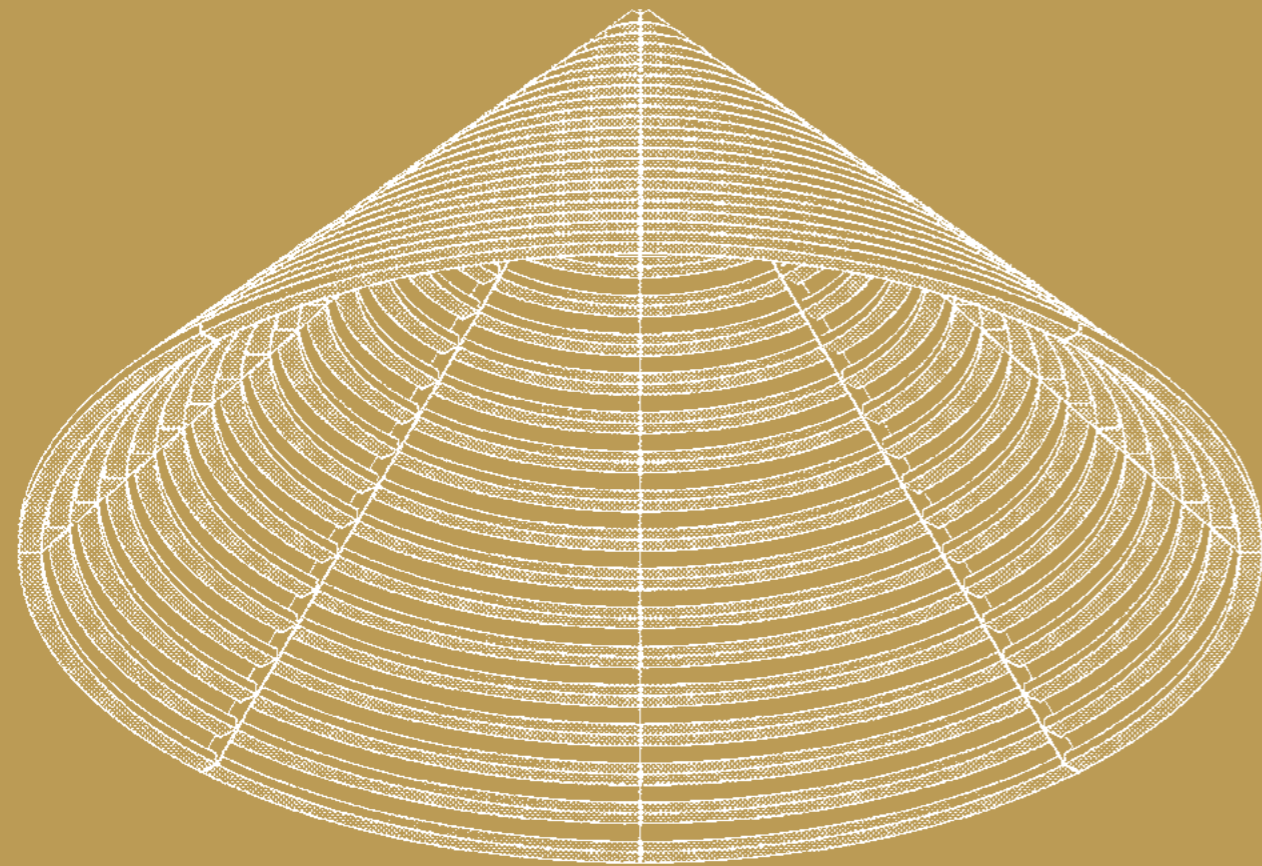

Special conical structure.



# Hover

Designed by YOY

Year 2022

The *Hover* table and floor lamps feature a lamp shade that looks as if it is detached from the base, connected seamlessly by a single cable that runs through the stem and comes out of the other end. The end result creates an illusion that the light source is almost weightless and floating in the air, like a balloon. *Hover* features a dimmer controlled by a power switch on the upper end of the stem; users can simply touch the top of the stem to modulate the intensity of the light. All typically external technical functions have been carefully incorporated within the lamp's internal structure. Additionally, the power supply comes in the form of a USB cable.

Le lampade da tavolo e da terra *Hover* presentano un paralume che sembra separato dalla base, collegato perfettamente da un unico cavo che attraversa lo stelo per poi uscirne. Il risultato finale crea l'illusione che la sorgente luminosa sia quasi priva di peso e fluttui nell'aria, come un palloncino. *Hover* è dotata di un dimmer controllato da un interruttore di alimentazione posto all'estremità superiore dello stelo; gli utenti possono semplicemente toccare la parte superiore dello stelo per modulare l'intensità della luce. Tutte le funzioni tecniche tipicamente esterne sono state accuratamente incorporate nella struttura interna della lampada. Inoltre, l'alimentazione è fornita grazie ad un cavo USB.

Go to the technical info [+](#) Click to discover more [↓](#)

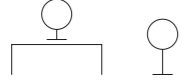
Hover COD. 184	CATEGORY LAMP		TYPE OF LIGHT	
	Table Floor	Tavolo Terra	Diffused light	Luce diffusa
				



Hover table and floor, FINISH Matte White.









Hover, switch on and off and dim the light intensity.



Hover, the lamp shade is connected seamlessly by a single cable that runs through the stem and comes out of the other end.





Hover table, FINISH Matte White.



Hover, USB socket.



Hover table, FINISH Matte White.



L'abat-jour des lampes de table et des lampadaires *Hover* semble séparé de la base et parfaitement relié par un câble unique qui traverse entièrement la tige. Le résultat final crée l'illusion d'une source lumineuse qui flotte dans l'air quasiment en apesanteur, comme un ballon. *Hover* est équipé d'un gradateur commandé par un interrupteur d'alimentation situé à l'extrémité supérieure de la tige ; les utilisateurs n'ont qu'à toucher le haut de la tige pour moduler l'intensité de la lumière. Toutes les fonctions techniques habituellement externes ont été soigneusement intégrées dans la structure interne de la lampe. En outre, l'alimentation est fournie via un câble USB. Disponible en lampe de table ou en lampadaire, *Hover* convient à différents usages, comme lampe de bureau, de table basse ou à côté d'un canapé. La version au sol peut également être installée dans des espaces publics tels qu'un lounge d'aéroport, une chambre d'hôtel ou un hall. ● FR

Die Tisch- und Stehleuchten *Hover* verfügen über einen Leuchtschirm, der vom Sockel getrennt zu sein scheint, verbunden auf perfekte Weise durch ein einziges Kabel, das durch den Schaft hindurch und aus ihm herausführt. Das Endergebnis erzeugt die Illusion, dass die Lichtquelle fast schwerelos ist und wie ein Ballon in der Luft schwebt. *Hover* ist mit einem Dimmer ausgestattet, der über einen Schalter am oberen Ende des Schaftes reguliert wird; die Benutzer können die Lichtintensität durch einfaches Berühren des oberen Endes des Schaftes einstellen. Alle typischen externen technischen Funktionen wurden sorgfältig in die innere Struktur der Leuchte integriert. Außerdem erfolgt die Stromversorgung über ein USB-Kabel. Erhältlich als Tisch- oder Stehleuchte, eignet sich *Hover* für verschiedene Verwendungszwecke, z. B. auf einem Schreibtisch, einem Beistelltisch oder neben einem Sofa. Die Bodenversion kann auch in öffentlichen Räumen wie einer Flughafenlounge, einem Hotelzimmer oder einer Empfangshalle eingesetzt werden. ● DE

Las lámparas de sobremesa y de pie *Hover* poseen una pantalla que parece separada de la base, conectada perfectamente por un solo cable que atraviesa la barra y luego sale. El resultado final da la sensación de que la fuente luminosa prácticamente no pesa y flota en el aire, como un globo. *Hover* está equipada con un regulador que controla un interruptor de alimentación situado en el extremo superior de la barra; los usuarios, simplemente tocando la parte superior de la barra, pueden regular la intensidad de la luz. Todas las funciones técnicas que normalmente están fuera se han incorporado minuciosamente en la estructura interna de la lámpara. Además, la alimentación se suministra gracias a un cable USB. *Hover*, disponible como lámpara de sobremesa o de pie, se adapta a distintos usos, como por ejemplo en un escritorio, una mesita o junto a un sofá. La versión de pie también se puede utilizar en espacios públicos como en la sala de un aeropuerto, una habitación de hotel o un vestíbulo. ● ES

Настольные лампы и торшеры *Hover* имеют абажур, который кажется отделенным от основания и соединенным одним кабелем, пересекающим стержень, а затем выходящим наружу. В результате возникает иллюзия невесомости источника света, парящего в воздухе, как воздушный шар. *Hover* оснащен диммером, управляемым выключателем, расположенным на верхнем конце стержня; пользователи могут отрегулировать интенсивность света, просто прикоснувшись к верхней части стержня. Все технические функции, обычно находящиеся снаружи, были встроены во внутреннюю структуру светильника. Питание также подается по кабелю USB. *Hover* выпускается в виде настольной лампы или торшера, и подходит для различного применения, на письменном столе, журнальном столике или рядом с диваном. Напольный вариант может также устанавливаться в общественных зданиях, например в зале аэропорта, в гостиничном номере или в холле. ● RU

*Hover*的台灯款和落地灯款均带有一个看似与底座分开的灯罩，但灯罩与底座之间却由一根从灯罩部位穿插而过的单根线缆完美连接。最终结果营造一种幻觉，光源仿佛几乎没有重量且会像气球一般漂浮于空中。*Hover*配有一部由位于灯罩上端的电源开关控制的调光器；用户只需轻触灯罩顶部便可调节光的强度。所有典型的外部技术功能均已巧妙整合至灯件的内部结构之中。此外，电源供给是通过一根USB线缆完成的。*Hover*提供台灯或落地灯两个版本，适用于不同用途，例如放在书桌、咖啡桌上或沙发近旁。落地灯版本也可用于机场休息室、酒店房间或大堂等公共场所。● ZH

## CATEGORY FLOOR LAMP

## Hover

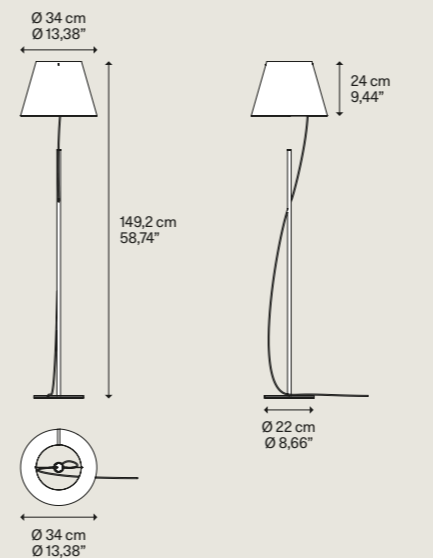

Net weight	3,86 kg	Pack	2	Energy class	C
Peso netto	8,51 lbs	Colli		Classe energetica	

## DESIGN YOY, 2022

Metal structure  
Montatura in metallo

Matte White  
Bianco Opaco

Paper diffuser  
Diffusore in carta

Matte White  
Bianco Opaco

Code  
Codice

18471 1027

Light source  
Sorgente luminosa

LED  
2700 K  
6,5 W  
1000 lm  
5 V  
2 A

CRI 90  
MacAdam 3-Step

LED, driver and touch dimmer included  
LED, driver e touch dimmer inclusi

USB adaptor included  
Adattatore USB incluso



## CATEGORY TABLE LAMP

## Hover

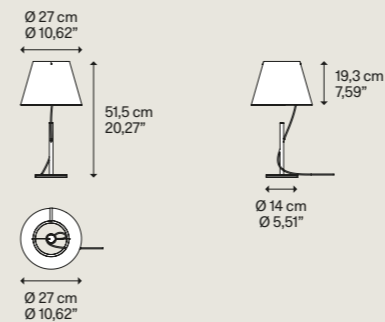

Net weight	1,68 kg	Pack	2	Energy class	C
Peso netto	3,70 lbs	Colli		Classe energetica	

## DESIGN YOY, 2022

Metal structure  
Montatura in metallo

Matte White  
Bianco Opaco

Paper diffuser  
Diffusore in carta

Matte White  
Bianco Opaco

Code  
Codice

18480 1027

Light source  
Sorgente luminosa

LED  
2700 K  
6,5 W  
1000 lm  
5 V  
2 A

CRI 90  
MacAdam 3-Step

LED, driver and touch dimmer included  
LED, driver e touch dimmer inclusi

USB adaptor included  
Adattatore USB incluso



Hover » Floor lamp

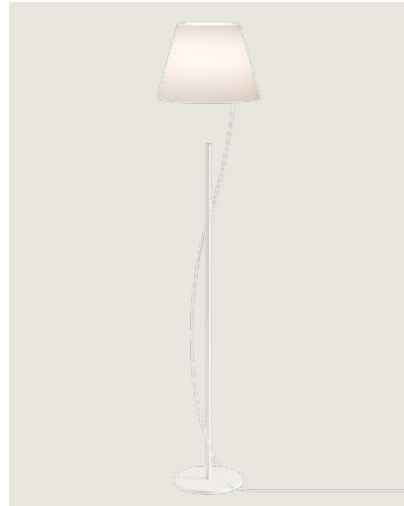

Hover » Table lamp



## Touch dimmer



# Blow

Designed by Pio & Tito Toso

Year 2005

As light as a breath, *Blow* is an ethereal and original table lamp. Made from blown glass, it contains a bright light that can be directed inside the diffuser to create ever-different beams. Perfect for reading or furnishing personal and intimate spaces.

Leggera come un respiro, *Blow* è una lampada da tavolo eterea e ingegnosa. Realizzata in vetro soffiato, contiene una luce vivace che si può orientare all'interno del diffusore per creare fasci luminosi ogni volta diversi. Ideale per leggere e per arredare spazi personali e intimi.

[Go to the technical info](#) 
[Click to discover more](#) 

Blow  
COD. 008

CATEGORY LAMP

Table                      Tavolo

TYPE OF LIGHT

Symmetrical diffused light                      Luce simmetrica diffusa  
Adjustable light                                      Luce orientabile







Blow, easy personalisation of light: adjust the light.

Légère comme un souffle, *Blow* est une lampe sur table éthérée et ingénieuse. Réalisée en verre soufflé, elle renferme une lumière vivace qui peut être orienté à l'intérieur du diffuseur pour créer des faisceaux de lumière tous différents. Idéale pour la lecture et pour décorer les espaces personnels et intimes. ● FR

So leicht wie der Atem ist *Blow* eine himmlische und erfinderische Tischlampe. Hergestellt aus mundgeblasenem Glas, enthält die Leuchte ein lebhaftes Licht, das innen im Diffusor ausgerichtet werden kann, um stets neue Lichtstreifen entstehen zu lassen. Ideal zum Lesen und zum Einrichten persönlicher und intimer Räume. ● DE

Ligera como un suspiro, *Blow* es una etérea ingeniosa lámpara de sobremesa. Fabricada en vidrio soplado, contiene una luz brillante que puede orientarse dentro del difusor para crear diferentes haces de luz cada vez. Ideal para leer y para decorar espacios personales e íntimos. ● ES

Легкий как дыхание, *Blow* – это изящный и очень оригинальный настольный светильник. Этот светильник, изготовленный из выдувного стекла, заключает в себе живой и динамичный свет, который можно ориентировать внутри диффузора для создания всякий раз других световых пучков. Идеально подходит для чтения и для оформления личных и интимных пространств. ● RU

轻如呼吸, *Blow* 是一款灵动而巧妙的台灯。由吹制玻璃制成, 含有充满活力光线, 可以将其定向到灯罩的内部, 每次发出不同的光束。阅读和布置个人和私密空间的理想之选。● ZH

**CATEGORY** TABLE LAMP

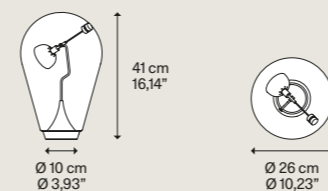
**Blow**

**DESIGN** Pio & Tito Toso, 2005

**Metal structure**  
**Montatura in metallo**



 Chrome  
 Cromo

**Blown glass diffuser**  
**Diffusore in vetro soffiato**

 Clear  
 Trasparente

**Code**  
**Codice**
**00880 27**
**Light source**  
**Sorgente luminosa**
**LED**  
**2700**      **K**  
**4,5**        **W**  
**500**        **lm**  
**500**        **mA**  
**CRI 90**  
**MacAdam 3-Step**  
 LED and driver included  
 LED e driver inclusi

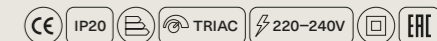
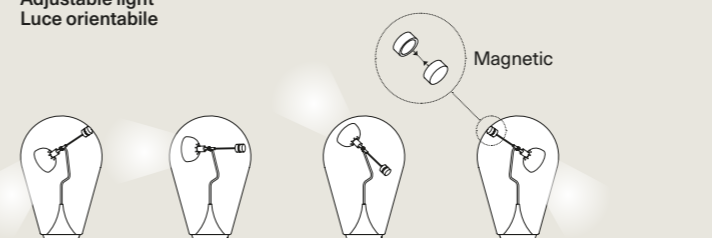
Net weight	4,00 kg	Pack	1	Energy class	C
Peso netto	8,82 lbs	Colli		Classe energetica	

**Adjustable light**  
**Luce orientabile**

Blow ▾ Table lamp





# Easy Peasy

Designed by Luca Nichetto

Year 2020

With a strong personality and a sculptural form reminiscing the shape of bells, *Easy Peasy* is a set of portable and rechargeable table lamps, consisting of two rounded elements, a body and a knob. Made of blown glass, *Easy Peasy* allows for personal customisation of the living spaces. Its portability, different shapes and colours, and the Dim-to-Warm functionality of its light source allow users to connect, play and interact with the variable configuration options. It is not just a table lamp: it is a real character to interact with!

Con una spiccata personalità e una linea sculturale che ricorda la forma delle campane, *Easy Peasy* è un set di lampade da tavolo portatili e ricaricabili, composte da due elementi stoncati, un corpo e un pomolo. Realizzata in vetro soffiato, *Easy Peasy* permette la personalizzazione individuale degli spazi abitativi. La sua portabilità, le diverse forme e colori e la funzione Dim-to-Warm della sorgente luminosa a LED permettono agli utenti di interagire, giocare e dialogare con le differenti possibilità di configurazione della luce. Non è solo una lampada da tavolo: è un vero e proprio personaggio con cui interagire!



Go to the technical info [+](#) Click to discover more [↓](#)

Easy Peasy COD. 170	CATEGORY LAMP		TYPE OF LIGHT	
	Cordless table lamp	Lampada da tavolo senza filo	Diffused light	Luce diffusa
				



Easy Peasy, micro USB socket.

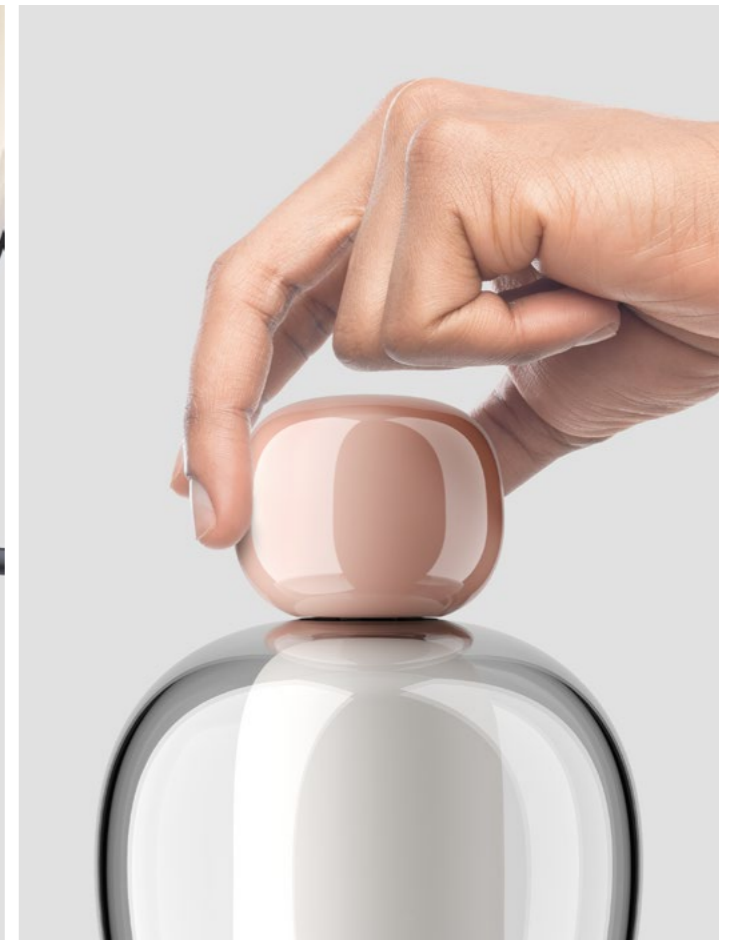

Easy Peasy, turn on and off, dim light intensity and warmth.



Easy Peasy, portable and rechargeable table lamp.







Avec sa forte personnalité et une ligne sculpturale qui rappelle la forme des cloches, *Easy Peasy* est un ensemble de lampes sur table portables et rechargeables, composé de deux éléments arrondis, un corps et un pommeau. Réalisée en verre soufflé, *Easy Peasy* permet la personnalisation individuelle des espaces de vie. Sa portabilité, ses différentes formes et couleurs et la fonction « Dim-to-Warm » de la source lumineuse à LED permettent aux utilisateurs d'interagir, de jouer et de dialoguer avec les différentes possibilités de configuration de la lumière. Ce n'est pas seulement une lampe de table : c'est un véritable personnage avec lequel on peut interagir! ● FR

Mit einer besonderen Persönlichkeit und einer skulpturalen Linie, die an die Form einer Glocke erinnert, ist *Easy Peasy* ein Set aus mitnehmbaren und aufladbaren Tischleuchten, bestehend aus zwei abgerundeten Elementen, einem Korpus und einem Knäuf. Aus geblasenem Glas hergestellt, ermöglicht *Easy Peasy* eine individuelle Personalisierung der Wohnräume. Die Mitnehmbarkeit, die verschiedenen Formen und Farben sowie die Funktion Dim-to-Warm der LED-Lichtquelle ermöglichen den Nutzern mit den verschiedenen Konfigurationsmöglichkeiten für das Licht zu interagieren, zu spielen und in Dialog zu treten. Es ist nicht nur eine Tischlampe: Es ist eine echte Figur, mit der man interagieren kann. ● DE

Con una marcada personalidad y una línea escultural que recuerda la forma de las campanas, *Easy Peasy* es un set de lámparas de sobremesa portátiles y recargables, compuestas por dos elementos redondeados, un cuerpo y un pomo. Realizada en vidrio soplado, *Easy Peasy* permite la personalización individual de los espacios habitacionales. Su portabilidad, las diversas formas y colores y la función Dim-to-Warm de la fuente luminosa a LED permiten a los usuarios interactuar, jugar y dialogar con las diferentes posibilidades de configuración de la luz. No es sólo una lámpara de mesa: es un personaje real con el que interactuar. ● ES

Обладающие ярко выраженной индивидуальностью и скульптурным силуэтом, напоминающим форму колокола, светильники *Easy Peasy* – это серия портативных перезаряжаемых настольных ламп, состоящих из двух закругленных элементов, корпуса и ручки. Лампы *Easy Peasy*, изготовленные из выдувного стекла, придают оформлению жилого пространства самобытность и оригинальность. Портативность, разнообразие форм и цветов, а также функция Dim-to-Warm источника света LED позволяют пользователям взаимодействовать, фантазировать и применять возможности различных конфигураций освещения. Это не только настольный светильник – это настоящий персонаж с которым можно контактировать. ● RU

*Easy Peasy*具有强烈的个性和雕塑感，酷似铃铛的形状，它是一组便携式可充电台灯，由两个圆形元素组成，一个主体和一个圆头。台灯由吹制玻璃制成，*Easy Peasy*可实现生活空间的个性化定制。它的便携性、不同的形状和颜色及其LED光源Dim-to-Warm的调光功能，允许用户与不同的灯光配置选项进行交互、游戏和对话。*Easy Peasy*不仅是盏台灯：它是一个具有个性能与空间互动的活泼伙伴。● ZH



Easy Peasy, packaging.

Flamingo

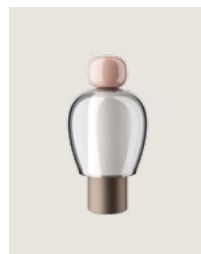

Lagoon



Kelp



Chestnut



#### CATEGORY CORDLESS TABLE LAMP

### Easy Peasy

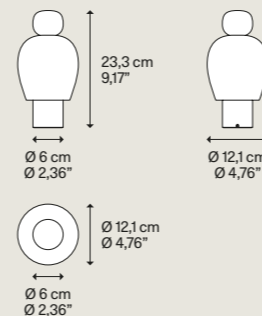

#### Light source Sorgente luminosa

LED  
Dim-to-Warm  
FROM 2200 K  
TO 2700 K  
5 W  
380 lm  
2000 mA Battery  
CRI 90  
MacAdam 3-Step

LED and battery included  
LED e batteria inclusi

#### Battery charging time Tempo di ricarica

Power supply  
1A ▶ 180 min

#### Battery life Durata batteria

Full power 100% ▶ 6h  
Half power 50% ▶ 10h  
Min power 10% ▶ 19h

Net weight Peso netto	0,85 kg 1,87 lbs	Pack Colli	1	Energy class Classe energetica	D
--------------------------	---------------------	---------------	---	-----------------------------------	---



### Easy Peasy

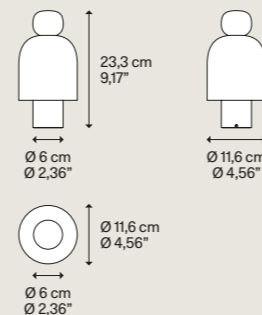

#### Light source Sorgente luminosa

LED  
Dim-to-Warm  
FROM 2200 K  
TO 2700 K  
5 W  
380 lm  
2000 mA Battery  
CRI 90  
MacAdam 3-Step

LED and battery included  
LED e batteria inclusi

#### Battery charging time Tempo di ricarica

Power supply  
1A ▶ 180 min

#### Battery life Durata batteria

Full power 100% ▶ 6h  
Half power 50% ▶ 10h  
Min power 10% ▶ 19h

Net weight Peso netto	0,85 kg 1,87 lbs	Pack Colli	1	Energy class Classe energetica	D
--------------------------	---------------------	---------------	---	-----------------------------------	---



#### DESIGN Luca Nichetto, 2020

### Flamingo

#### Technopolymer knob Pomolo in tecnopolimero

Pink  
Rosa

#### Blown glass shade Cappello in vetro soffiato

Grey  
Grigio

#### Metal base Base in metallo

Brushed Bronze  
Bronzo Spazzolato

#### Code Codice

17081 6226

### Lagoon

#### Technopolymer knob Pomolo in tecnopolimero

Turquoise  
Turchese

#### Blown glass shade Cappello in vetro soffiato

Honey  
Miele

#### Metal base Base in metallo

Brushed Gold  
Oro Spazzolato

#### Code Codice

17081 8126

### Kelp

#### Technopolymer knob Pomolo in tecnopolimero

Green  
Verde

#### Blown glass shade Cappello in vetro soffiato

Honey  
Miele

#### Metal base Base in metallo

Brushed Rose Gold  
Oro Rosa Spazzolato

#### Code Codice

17081 7226

### Chestnut

#### Technopolymer knob Pomolo in tecnopolimero

Taupe  
Grigio Caldo

#### Blown glass shade Cappello in vetro soffiato

Grey  
Grigio

#### Metal base Base in metallo

Brushed Palladium  
Palladio Spazzolato

#### Code Codice

17081 3826



# Croma

Designed by Luca Nichetto

Year 2021

Taking its name from the Italian word for a *'quaver'* or *'eighth'*, *Croma* reflects the dynamism of the musical note in its slender frame. It features a conical base that provides stability and a sleek body which casts a powerful ray of light from its LED source. A ring conveniently positioned halfway up the stem allows the user to control the LED module, and to utilise its Dim-to-Warm function. Its two unique metallic ombré colourways and the two texturised white and black finishes make *Croma* suitable for a variety of environments, including residential, hotel and hospitality.

La nuova lampada da terra richiama nel nome la *"croma"* o *"ottavo"*: la sua struttura slanciata che proietta fasci di luce lungo la parete verso il soffitto evoca il dinamismo della nota musicale. *Croma* ha una base conica che le conferisce stabilità e una silhouette longilinea che proietta un potente raggio di luce dalla sorgente LED. Un anello posizionato a metà altezza dello stelo consente all'utente di regolare il modulo a LED e gestire la funzione Dim-to-Warm. Le due finiture metallizzate ombré, e le due tonalità testurizzate bianco e nero rendono *Croma* adatta a una varietà di ambienti, dal residenziale all'hotel e ospitalità.

Go to the technical info [+](#) Click to discover more [↓](#)

Croma COD. 172	CATEGORY LAMP		TYPE OF LIGHT	
	Floor	Terra	Symmetrical diffused light Indirect light	Luce simmetrica diffusa Luce indiretta
				



Croma, FINISHES Matte White and Matte Black.

Croma, Dim-to-Warm from 2200 to 3200 K

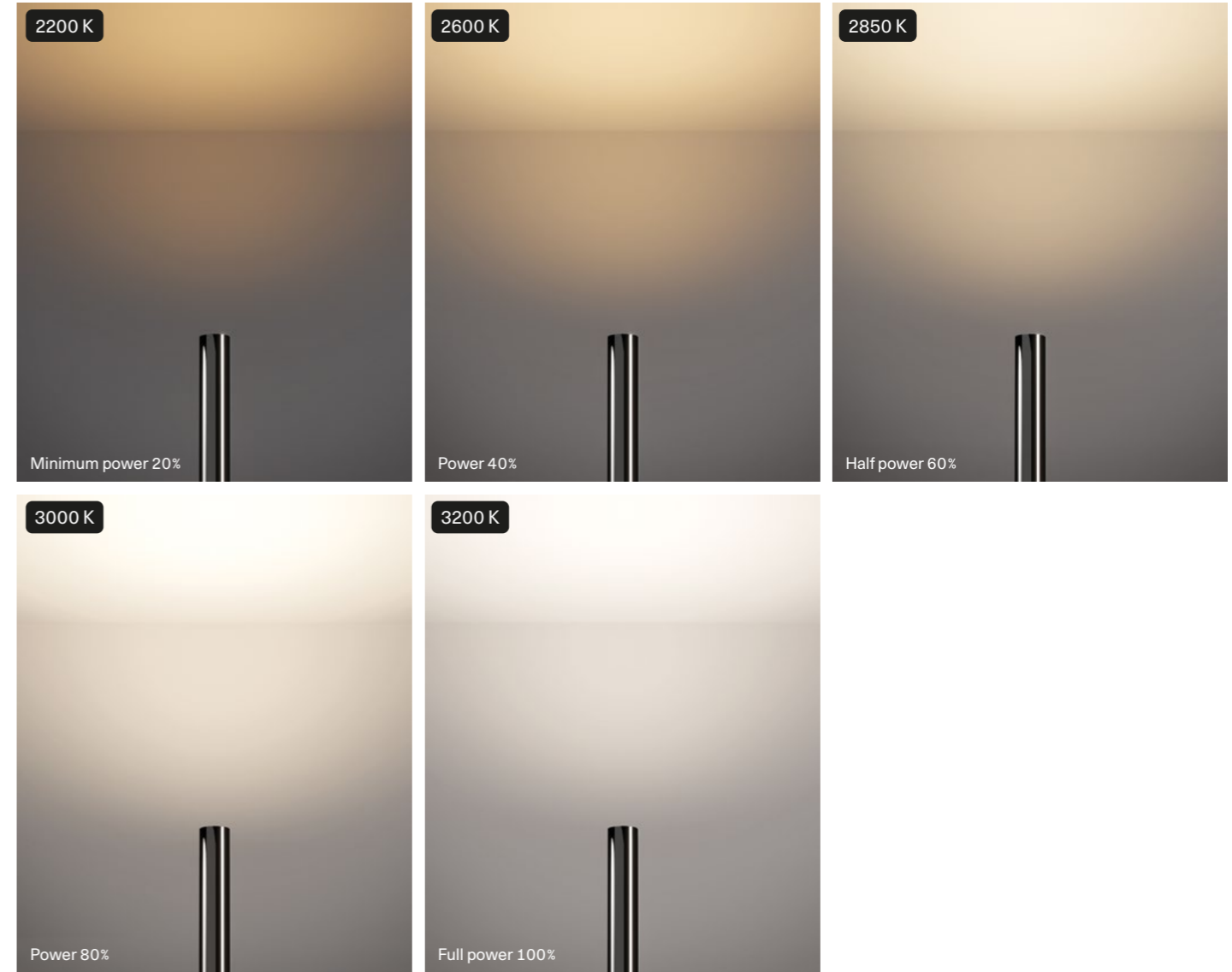

Turn on and off, dim light intensity and warmth.

Croma, light source.



Le nouveau lampadaire prend son nom du mot italien désignant une *croche* ou une *hampe* : sa structure élancée dissipe les faisceaux de lumière vers le haut du mur et le plafond pour évoquer le dynamisme de la note de musique. *Croma* s'appuie sur une base conique qui assure sa stabilité et lui donne une allure longiligne qui projette un puissant rayon de lumière de la source LED. Un anneau placé à mi-hauteur de la hampe permet à l'utilisateur de contrôler le module LED et de gérer la fonction Dim-to-Warm. Grâce aux deux nouvelles finitions métallisées ombré et aux deux tonalités texturisées blanche et noire, *Croma* épouse toute une variété d'ambiances, du résidentiel à l'hôtellerie et à l'accueil. ●FR

Der Name der neuen Stehleuchte leitet sich vom italienischen Wort für "Achtelnote" oder "Achtel" ab: Ihre schlanke Struktur, die die Lichtstrahlen entlang der Wand in Richtung Decke projiziert, spiegelt die Dynamik der Musiknote wider. *Croma* hat einen konischen Sockel, der ihr Stabilität verleiht und eine langgestreckte Silhouette, die einen kraftvollen Lichtstrahl aus dem LED-Leuchtmittel abgibt. Ein auf halber Höhe des Ständers angebrachter Ring ermöglicht dem Benutzer, das LED-Modul zu steuern und die Dim-to-Warm-Funktion zu nutzen. Metallische Ombré Ausführungen und zwei strukturierte Schwarz- und Weißtöne ermöglichen den Einsatz von *Croma* in einer Vielzahl von Umgebungen, vom Wohnbereich bis hin zu Hotels und Hospitality. ●DE

La nueva lámpara de pie evoca en el nombre la *corchea* o *octava*: su estructura estilizada que proyecta haces de luz en la pared hacia el techo evoca el dinamismo de la nota musical. *Croma* descansa sobre una base cónica queda estabilidad a su silueta alargada que proyecta un potente rayo de luz de la fuente LED. Un anillo situado a media altura del pie le permite al usuario regular el módulo LED y controlar la función Dim-to-Warm. Los dos nuevos acabados metalizados ombré y los dos colores texturizados blanco y negro hacen que *Croma* sea apropiada para distintos ambientes, del residencial pasando por el hotelero a la hostelería. ●ES

Новый торшер напоминает своим названием итальянское слово «*срома*» или «*восьмой*»: его утонченная структура, проецирующая лучи света вдоль стены к потолку, ассоциируется с динамизмом музыкальной ноты. *Croma* имеет коническое основание, которое придает лампе устойчивость и утонченность силуэта. Лампа проецирует мощный луч света от светодиодного источника. Кольцо, расположенное на середине ноги торшера, позволяет пользователю регулировать светодиодный модуль и управлять функцией Dim-to-Warm. Две новые металлизированные отделки деграде и две новые текстурированные тональности черного и белого делают лампу *Croma* подходящей для самых разных применений, от жилых помещений до отелей и структур по приему гостей. ●RU

新款落地灯呼应“颤音”或“八分音符”之名:纤细修长的结构沿着墙壁向天花板散射光束,唤起音符之活力。*Croma*有一个锥形底座,该底座为其赋予稳定性以及一个可从LED光源投射出强烈光线的纤长轮廓。一只位于灯茎一半处的圆环使用户能够调整LED模块并管理从暗到暖的调光功能。两种金属渐变效果饰面以及纯白色和黑色两种纹理色调,使*Croma*适用于包括住宅、酒店及招待场所在内的各类环境。●ZH

CATEGORY FLOOR LAMP

Croma

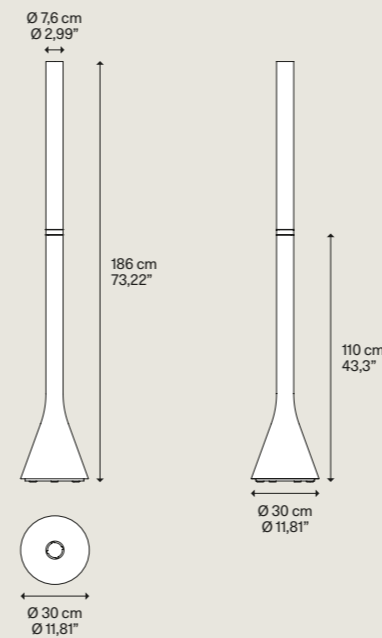

Net weight	15,00 kg	Pack	1	Energy class	E
Peso netto	33,07 lbs	Colli		Classe energetica	

DESIGN Luca Nichetto, 2021

Metal structure  
Montatura in metallo

	Code Codice
Matte White - 9010 Bianco Opaco - 9010	17270 1000
Matte Black - 9005 Nero Opaco - 9005	17270 2000
Bronze Bronzo	17270 3400
Green Verde	17270 7000

Light source  
Sorgente luminosa

LED  
Dim-to-Warm  
FROM 2200 K  
TO 3200 K  
42 W  
5600 lm  
220-240 V  
CRI 90  
MacAdam 3-Step

Dim-to-Warm		
▶ 20%	2200 K	1400 lm
▶ 40%	2600 K	2400 lm
▶ 60%	2850 K	3550 lm
▶ 80%	3000 K	4600 lm
▶ 100%	3200 K	5600 lm

LED, driver and Dim-to-Warm dimmer included  
LED, driver e Dim-to-Warm dimmer inclusi



Croma ▾ Floor lamp



# Flar

Designed by Patrick Norguet

Year 2022

The name *Flar* evokes images of a flare or ‘flamboiemment’ in French – an intense blaze or burst of light. Inspired by traditional storm lanterns which use glass pipes to protect the flame, *Flar* comprises a 3D laser cut steel base which opens like a flower, leading to a charmingly imperfect blown glass diffuser available in two sizes, 45 and 60 cm. *Flar* features a dimmer controlled with the cable mounted power switch, allowing users to modulate the intensity of the light to create their ideal lighting scheme. The two sizes offer an opportunity to play with scale to create a unique composition for a hotel lounge or retail space.

Il nome *Flar* evoca l’immagine di uno sfavillio o “flamboiemment”, che in francese indica un intenso bagliore o squarcio di luce. Ispirata alle tradizionali lanterne antivento dotate di tubi in vetro per proteggere la fiamma, *Flar* si poggia su una base in acciaio, realizzata con la tecnologia del taglio laser 3D, che si schiude come un fiore e accoglie un diffusore in vetro soffiato dall’effetto piacevolmente imperfetto. Disponibile nelle due versioni da 45 e 60 cm, *Flar* è provvista di un varialuce regolabile dall’interruttore montato sul cavo, che consente all’utente di modulare l’intensità della luce in base alle proprie preferenze. Le due dimensioni offrono la possibilità di giocare con le proporzioni, creando così composizioni uniche nelle aree lounge degli hotel o nei punti vendita.



Go to the technical info [+](#) Click to discover more [↓](#)

Flar COD. 191	CATEGORY LAMP		TYPE OF LIGHT	
	Table Floor	Tavolo Terra	Diffused light	Luce diffusa





Flar, 3D laser cut base, FINISH Champagne.



Flar, blown glass diffuser, FINISHES Honey and Turquoise.



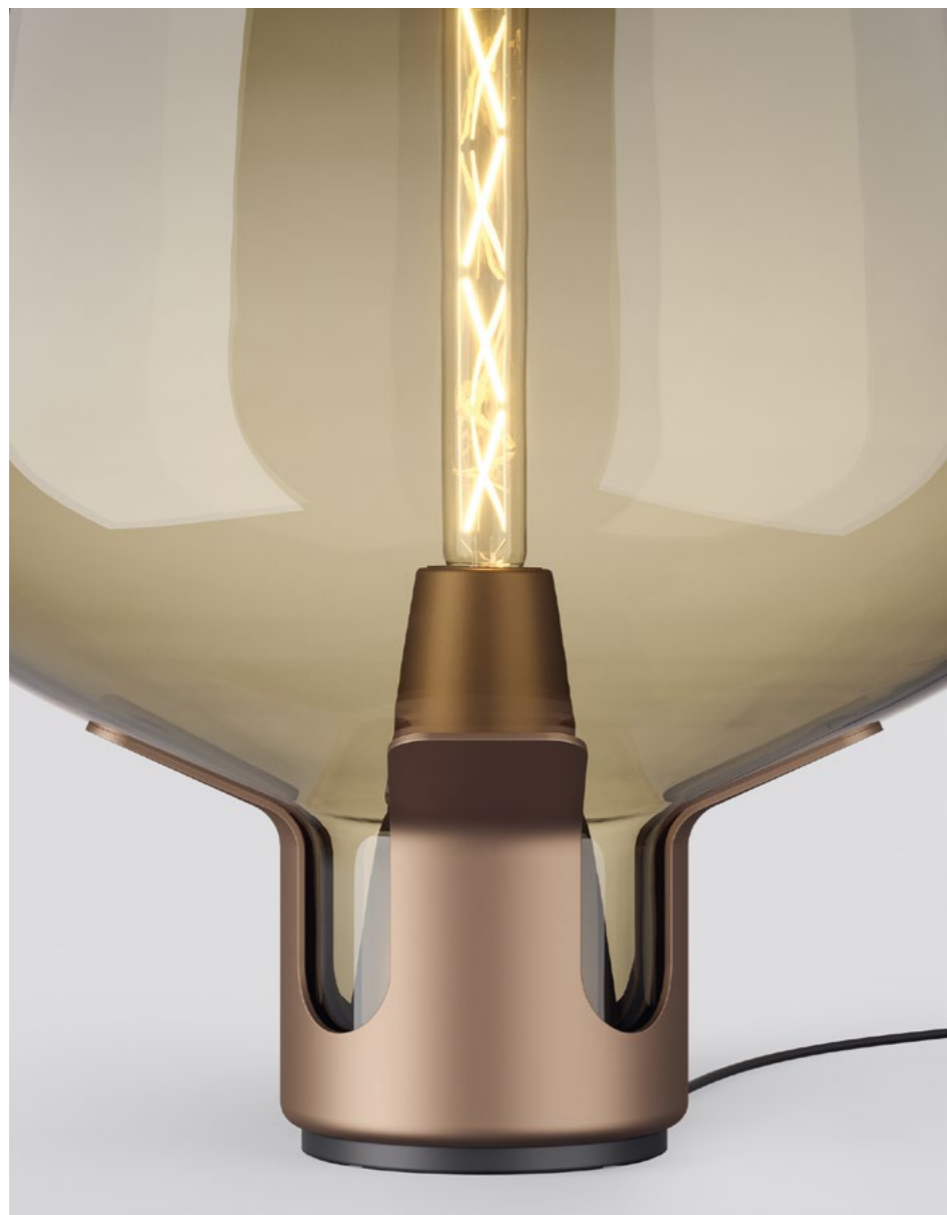



Le nom *Flar* évoque un flamboiement (Flare en anglais) – une flamme intense ou un éclat de lumière. S’inspirant des lanternes tempête traditionnelles qui utilisent des cylindres de verre pour protéger la flamme, *Flar* se compose d’une base en acier découpée au laser 3D qui s’épanouit comme une fleur, portant à un diffuseur en verre soufflé d’une séduisante imperfection disponible en deux tailles, 45 et 60 cm. *Flar* dispose d’un variateur contrôlé par l’interrupteur d’alimentation monté sur câble, permettant à l’utilisateur de moduler l’intensité de la lumière pour créer l’éclairage idéal. Les deux tailles offrent la possibilité de jouer avec les variations pour une composition unique dans un hall d’hôtel ou un magasin. ● FR

Der Name *Flar* erinnert an eine Fackel oder ‘flamboiement’ im Französischen – ein intensives Aufflammen oder Ausbrechen von Licht. Inspiriert von traditionellen Sturmlaternen, die Glasrohre zum Schutz der Flamme verwenden, besteht *Flar* aus einer 3D-gelaserten Basis aus Stahl, die sich wie eine Blume öffnet und sich zu einem bezaubernden nicht perfekten Diffusor aus mundgeblasenem Glas entwickelt, der in zwei Größen erhältlich ist: 45 und 60 cm. *Flar* ist mit einem Dimmer ausgestattet, der über den am Kabel angebrachten Netzschalter gesteuert wird und es dem Benutzenden ermöglicht, die Intensität des Lichts zu modulieren, um das ideale Beleuchtungsschema zu schaffen. Die beiden Größen bieten die Möglichkeit, mit dem Maßstab zu spielen und eine einzigartige Komposition für eine Hotellounge oder einen Verkaufsraum zu schaffen. ● DE

El nombre *Flar* recoge ecos del término francés «flamboiement», una llamarada o un intenso estallido de luz. Inspirada por las tradicionales lanternas de tormenta que empleaban tubos de vidrio para proteger la llama, *Flar* incluye una base de acero cortada con láser 3D y que se abre como una flor para dar paso a un difusor de vidrio soplado atractivamente imperfecto disponible en dos tamaños, 45 y 60 cm. *Flar* incorpora un regulador que se controla con el interruptor montado en el cable y permite a los usuarios modular la intensidad de la luz para crear su esquema de iluminación ideal. Los dos tamaños ofrecen la oportunidad de jugar con la escala para crear una composición única para el recibidor de un hotel o para una tienda. ● ES

Название *Flar* вызывает в воображении образы вспышки или французское слово «flamboiement», означающее интенсивное пламя или вспышку света. Вдохновленная традиционными штормовыми фонарями, в которых применяются стеклянные трубки для защиты пламени, лампа *Flar* имеет стальное основание 3D, вырезанное лазером, раскрывающееся подобно цветку, ведущее к очаровательно несовершенному диффузору из дутого стекла двух размеров: 45 и 60 см. *Flar* оборудована диммером, управляемым при помощи переключателя питания, монтированного на кабель, для модуляции интенсивности света, позволяя пользователям создавать идеальную схему освещения. Два размера предоставляют возможность играть с масштабом, чтобы создавать уникальные композиции для гостиничного холла или торгового помещения. ● RU

*Flar*这个名字让人联想至耀斑之像或法语的‘flamboiement’一词—意为一股烈焰或一阵光耀。受到使用玻璃管保护火焰的传统防风灯启发,*Flar*包含一个3D激光切割钢底座,它像花朵一样张开,形成一个优美迷人的不完美吹制玻璃灯罩,提供45厘米和60厘米两种尺寸。*Flar*具有一个使用安装在线路上的电源开关进行控制的调光器,使用户能够调节光线强度,以创建理想的照明方案。两种尺寸提供延展发挥的机会,可为酒店休息室或零售空间创建独特别致的组合。● ZH

CATEGORY TABLE LAMP FLOOR LAMP

Flar medium

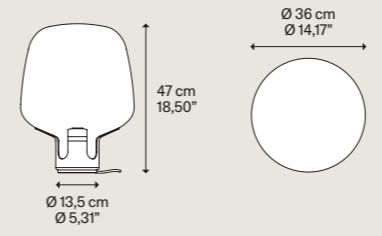

Net weight	6,77 kg	Pack	2
Peso netto	14,92 lbs	Colli	

DESIGN Patrick Norguet, 2022

Metal structure Montatura in metallo	Blown glass diffuser Diffusore in vetro soffiato	Code Codice
Champagne Champagne	Honey Miele	19182 6800
Champagne Champagne	Turquoise Turchese	19182 8600
Terra Terra	Honey Miele	19183 6800
Terra Terra	Turquoise Turchese	19183 8600

**Light source**  
Sorgente luminosa

**E27 T30 Tubular LED**  
1 × 6 W (max 25 W)

W/L max 22,5 cm  
W/L max 8,85"

Bulb not included  
Dimmer on the cord included

Lampadina non inclusa  
Dimmer nel filo incluso



Flar large

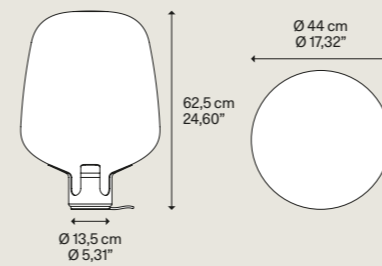

Net weight	9,89 kg	Pack	2
Peso netto	21,80 lbs	Colli	

Metal structure Montatura in metallo	Blown glass diffuser Diffusore in vetro soffiato	Code Codice
Champagne Champagne	Honey Miele	19184 6800
Champagne Champagne	Turquoise Turchese	19184 8600
Terra Terra	Honey Miele	19185 6800
Terra Terra	Turquoise Turchese	19185 8600

**Light source**  
Sorgente luminosa

**E27 T30 Tubular LED**  
1 × 7 W (max 25 W)

W/L max 30 cm  
W/L max 11,81"

Bulb not included  
Dimmer on the cord included

Lampadina non inclusa  
Dimmer nel filo incluso



Flar medium » Table lamp, Floor lamp



Flar large » Table lamp, Floor lamp



Light source Sorgente luminosa	Bulb dimension Dimensione lampadina	Lamp Lampada	Pack Colli	Code Codice
E27 T30 6 W	2500 K 620 lm	Flar medium	1	191A02
E27 T30 7 W	2500 K 800 lm	Flar large	1	191A03

# Cima

Designed by Marco Dessì

Year 2021

Inspired by the function of the jam cleats found in sailing boats, *Cima* – a nautical rope in Italian – is a “suspended” lamp characterised by a ceiling-to-floor rope, a sleek and highly functional design element. A joint that holds the lamp body slides vertically along the rope, while the counterweight allows to manage any excess rope. The simple cylindrical shapes and the black colour of these elements highlight the three brilliant finishes of the rope, vibrant accents to suit any interiors and décor mood.

Ispirata dalla funzione degli strozzascotte delle barche a vela, *Cima* è una lampada “sospesa” caratterizzata da una fune a tutt’altezza, elemento di design elegante e altamente funzionale. Lungo la fune scorre verticalmente un giunto che regge il corpo lampada, mentre il contrappeso permette di gestire l’eventuale fune in eccesso. Le semplici forme cilindriche e il colore nero di questi elementi risaltano le tre finiture brillanti della fune, accenti vibranti per qualsiasi ambiente e mood d’arredo.

Go to the technical info



Click to discover more



Cima  
COD. 173

CATEGORY LAMP

Suspension  
Floor

Sospensione  
Terra



TYPE OF LIGHT

Symmetrical diffused light  
Adjustable

Luce simmetrica diffusa  
Orientabile





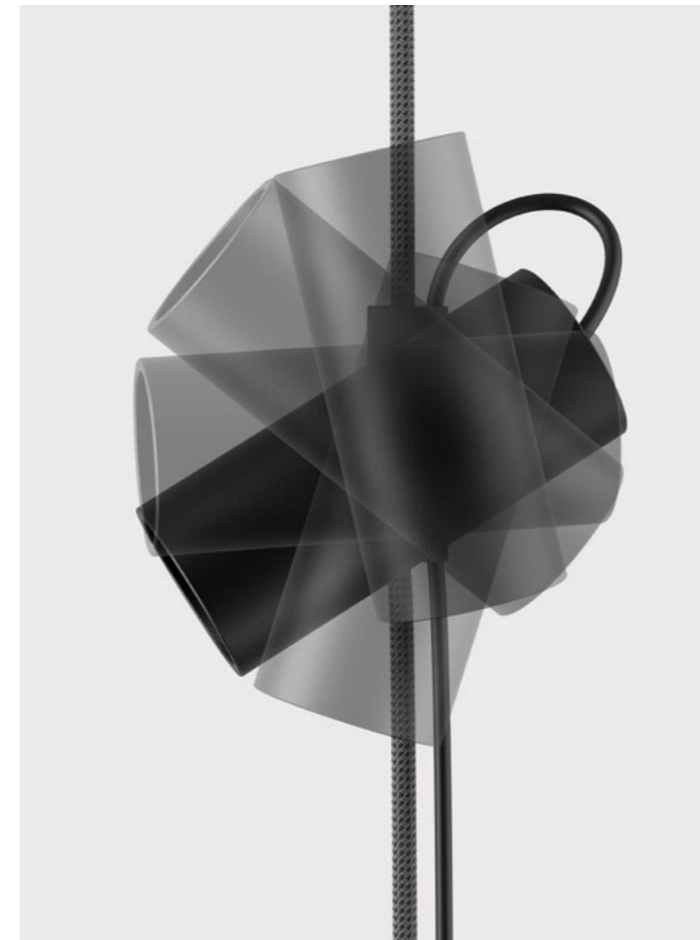

Cima, easy personalisation of light: change the angle of the lamp body.

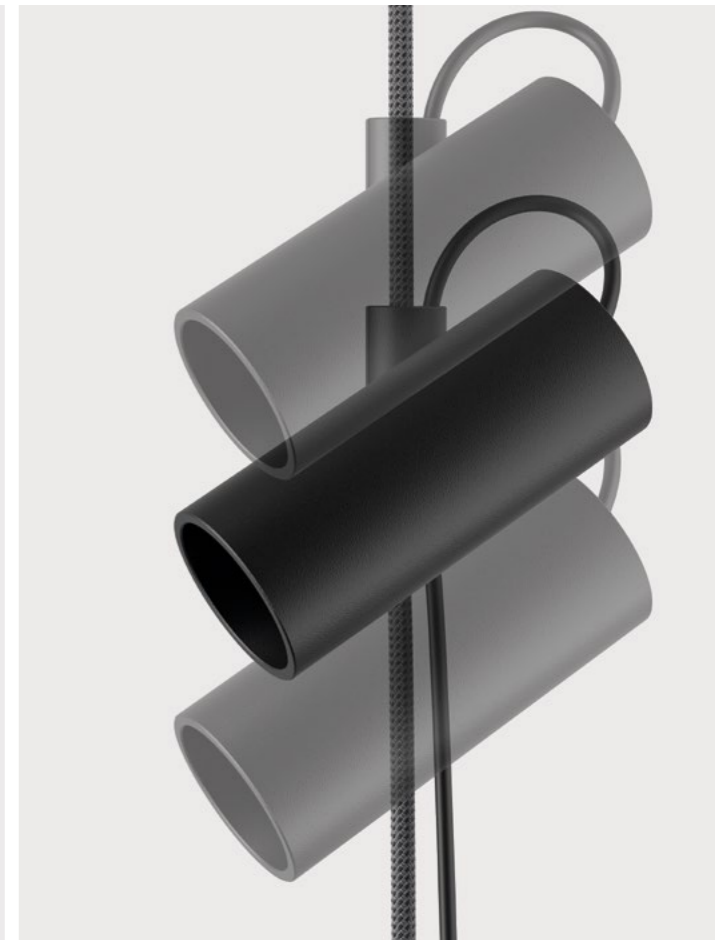

Cima, easy personalisation of light: adjust the height of the joint.

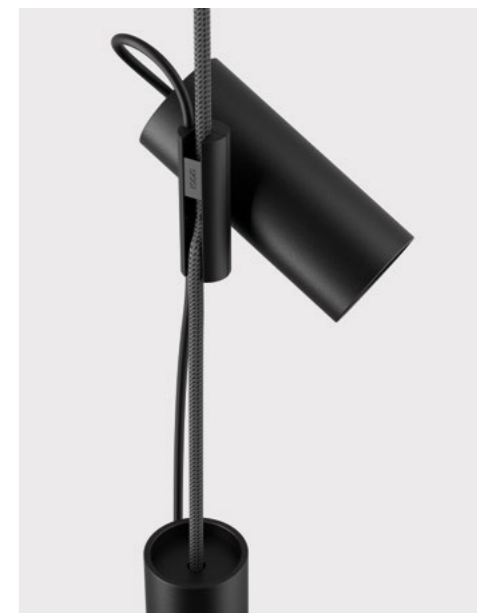

Cima, FINISH Silver.



Cima, FINISH Silver.



Cima, FINISH Silver, counterweight/switch button on the power cord.



Cima, FINISH Gold.



S'inspirant de la fonction des taquets de blocage des voiliers, *Cima* – une corde nautique en italien – est une lampe « *suspendue* » caractérisée par une corde plafond-sol, élément de design élégant et fonctionnel. Le raccord qui supporte le corps de la lampe se déplace le long de la corde, tandis que le contrepoids permet d'ajuster l'excès de corde. Les formes cylindriques simples et la couleur noire de ces éléments mettent en valeur les trois finitions brillantes de la corde pour s'adapter à tous les intérieurs et à tous les styles de décoration. ● FR

Inspiriert von der Funktion der Klampen, die in Segelbooten zu finden sind, ist *Cima* – das bedeutet Schiffsseil auf Italienisch – eine „hängende Leuchte“, die sich durch ein Decken-Boden-Seil auszeichnet, ein elegantes und hochfunktionales Designelement. Entlang des Seils bewegt sich ein Gelenk, das den Lampenkörper stützt, während das Gegengewicht es ermöglicht, einen eventuellen Seilüberschuss zu justieren. Die schlichten Formen und die schwarze Farbe dieser Elemente unterstreichen die drei brillanten Ausführungen des Seils, vibrierende Akzente, die für jedes Interieur und jede Dekor Stimmung geeignet sind. ● DE

Inspirada en la función de las cornamusas que se encuentran en los veleros, *Cima* – una cuerda náutica en italiano – es una lámpara “*suspendida*” caracterizada por una cuerda que va del techo al suelo, un elemento de diseño elegante y sumamente funcional. A lo largo de la cuerda se mueve verticalmente una articulación que sujeta el cuerpo de la lámpara, mientras que el contrapeso permite reajustar cualquier exceso de cuerda. Las sencillas formas cilíndricas y el color negro de estos elementos resaltan los tres acabados brillantes de la cuerda, las notas vibrantes de cualquier interior y decoración de ambiente. ● ES

Вдохновленный функцией палубных стопоров, используемых на парусных лодках, светильник *Cima* – «*корабельный канат*» на итальянском – представляет собой подвешенную лампу, с тросом в полную высоту, задуманным как изысканный и высоко функциональный элемент дизайна. Вдоль троса вертикально перемещается шарнир, поддерживающий корпус лампы, а противовес позволяет отрегулировать избыток троса. Простые цилиндрические формы и черный цвет этих элементов подчеркивают три яркие отделки троса, вибрирующие тональности, подходящие для любых интерьеров и стилей. ● RU

受帆船中防滑钉的功能之启发, *Cima* – 意大利语意为航海绳 – 是一款特征显著的“悬浮灯”, 一条全高式绳索便是其优雅且功能强大的设计元素。一块用来举持灯体的接头沿绳索垂直延伸, 而配重件则让您调节管理绳索的任何多余之处。这些元素的简约圆柱形状与黑色突出了绳索的三种光鲜饰面, 令任何室内环境与装饰风尚活力四射。● ZH

Cima » Suspension lamp, Floor lamp

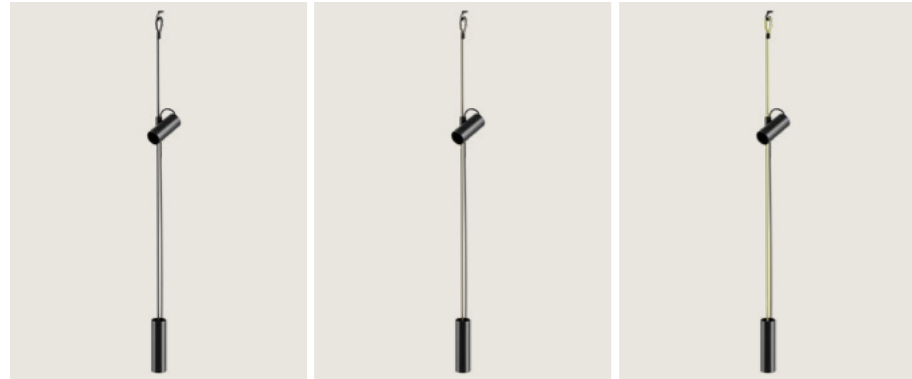

Cima » Set the rope at the desired length

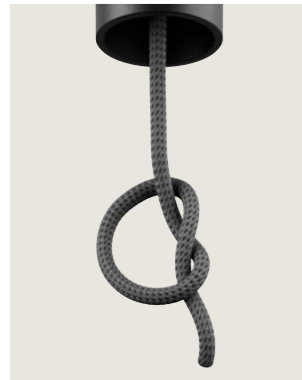

Finishes » Rope

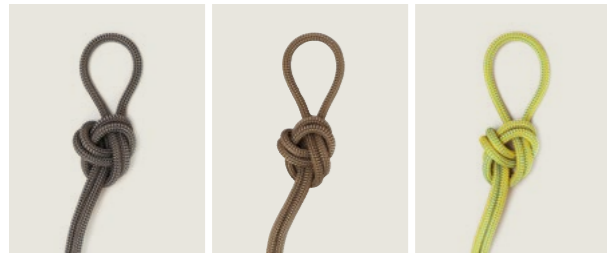

CATEGORY SUSPENSION LAMP FLOOR LAMP

Cima

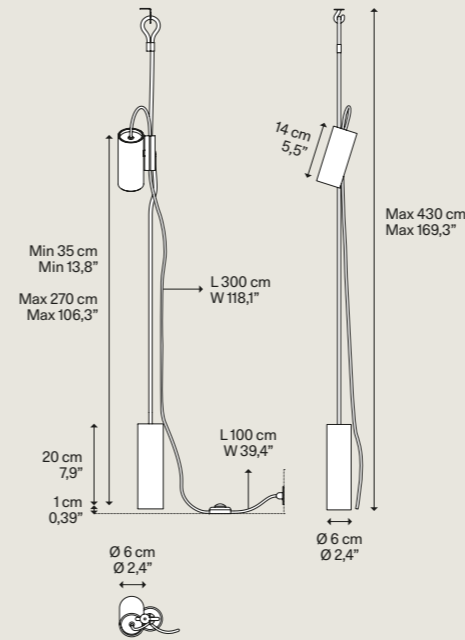

Net weight	1,75 kg	Pack	1
Peso netto	3,86 lbs	Colli	1

DESIGN Marco Dessì, 2021

Metal structure  
Montatura in metallo

- Matte Black  
Nero Opaco

Light source  
Sorgente luminosa

GU10 Par 16 LED 1x 10 W  
W/L max 9 cm  
W/L max 3,54"

Bulb and dimmer not included  
Lampadina e dimmer non inclusi

Description  
Descrizione

Additional kit (max 1 additional kit)

Light source  
Sorgente luminosa

GU10 Par 16 LED 1x 10 W  
W/L max 9 cm  
W/L max 3,54"

Bulb and dimmer not included  
Lampadina e dimmer non inclusi

Rope  
Corda

- Silver  
Argento
- Gold  
Oro
- Yellow  
Giallo

Code  
Codice

- 17371 4100
- 17371 5000
- 17371 5100

Metal structure  
Montatura in metallo

- Matte Black  
Nero Opaco

Code  
Codice







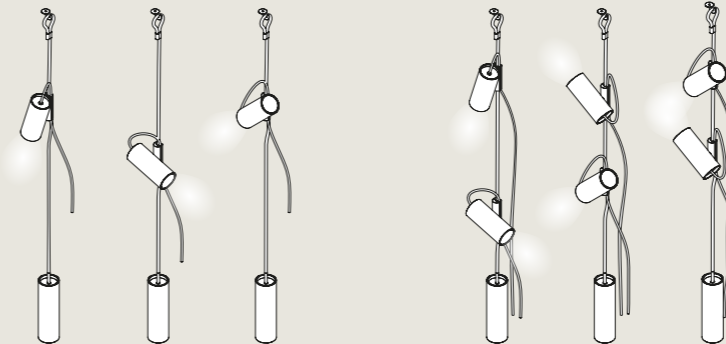



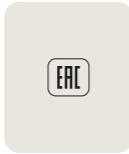

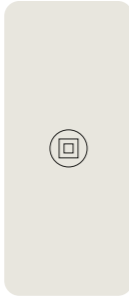

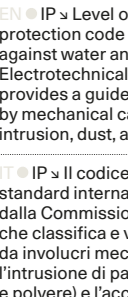
- 17371K 2000









Adjustable light  
Luce orientabile

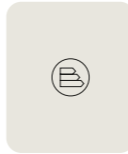

## Glossary

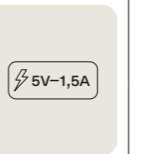
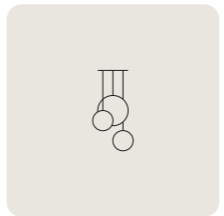
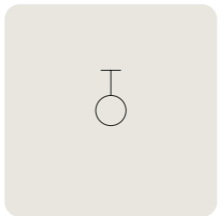
Certifications		
	<p><b>EN</b> ● This certifies that the product complies with the provisions of EC directives.</p> <p><b>IT</b> ● Attesta la conformità del prodotto alle disposizioni delle direttive comunitarie.</p>	
		<p><b>EN</b> ● EAC marking confirms the compliance of the products with the Eurasian Customs Union.</p> <p><b>IT</b> ● EAC un marchio che attesta la conformità delle merci alle norme dell'Unione doganale euroasiatica.</p>
Insulation Class		
	<p><b>EN</b> ● Class I device → connection to the yellow / green protective conductor (ground) is compulsory.</p> <p><b>IT</b> ● Apparecchio in Classe I → è obbligatoria la connessione al conduttore di protezione giallo / verde (messa a terra).</p>	
		<p><b>EN</b> ● Class II → device in which protection against electric shock is based solely on double and / or reinforced insulation. These devices do not have earthing devices.</p> <p><b>IT</b> ● Apparecchio in Classe II → nel quale la protezione contro la scossa elettrica si basa unicamente sul doppio isolamento e / o isolamento rinforzato. Questi apparecchi non prevedono dispositivi per la messa a terra.</p>
		
		<p><b>EN</b> ● Class III → device in which protection against electric shock is based on a separated extra low voltage (SELV) supply and in which no higher voltages are produced.</p> <p><b>IT</b> ● Apparecchio in Classe III → Apparecchio in cui la protezione contro la scossa elettrica si basa sull'alimentazione a bassissima tensione di sicurezza (SELV) e in cui non si producono tensioni superiori alla stessa.</p>
Levels of protection		
	<p><b>EN</b> ● IP → Level of protection. The IP code or ingress protection code indicates how well a device is protected against water and dust. It is defined by the International Electrotechnical Commission (IEC) which classifies and provides a guideline to the degree of protection provided by mechanical casings and electrical enclosures against intrusion, dust, accidental contact, and water.</p> <p><b>IT</b> ● IP → Il codice IP è un parametro definito dallo standard internazionale IEC 60529 (pubblicato dalla Commissione elettrotecnica internazionale), che classifica e valuta il grado di protezione fornito da involucri meccanici e quadri elettrici contro l'intrusione di particelle solide (quali parti del corpo e polvere) e l'accesso di liquidi.</p>	
		<p><b>EN</b> ● An IP20 rating means the product is touchproof and will be resistant to dust or objects that are over 12 mm in size.</p> <p><b>IT</b> ● Il grado di protezione IP20 significa che il prodotto è touchproof e resistente alle particelle di polvere o a oggetti di dimensioni superiori a 12 mm.</p>
		
		<p><b>EN</b> ● An IP44 rating means that your product will be protected from solid particles that are over 1 mm in size and from low velocity sprays of water from every direction.</p> <p><b>IT</b> ● Il grado di protezione IP44 significa che il prodotto è protetto da particelle solide di dimensioni superiori a 1 mm e da spruzzi d'acqua a bassa velocità provenienti da ogni direzione.</p>
	<p><b>EN</b> ● An IP54 rating means that your product will be protected against contamination from limited amounts of dust and other particles. Additionally, you can be confident that it will be protected from water sprays from all directions.</p> <p><b>IT</b> ● Il grado di protezione IP54 significa che il prodotto è protetto dalla contaminazione di quantità limitate di polvere e altre particelle. Inoltre, è garantita la protezione dagli spruzzi d'acqua provenienti da tutte le direzioni.</p>	
		<p><b>EN</b> ● An IP65 Rating means the product has the highest level of dust protection, and is able to withstand low-pressure water jets from all directions.</p> <p><b>IT</b> ● La classificazione IP65 significa che il prodotto ha il massimo livello di protezione dalla polvere ed è in grado di resistere a getti d'acqua a bassa pressione provenienti da tutte le direzioni.</p>
		
		<p><b>EN</b> ● Products with an IP67 Rating are waterproof due to their high levels of both solid and water ingress.</p> <p><b>IT</b> ● I prodotti con classificazione IP67 sono impermeabili grazie agli elevati livelli di resistenza all'ingresso di acqua e solidi.</p>
Dimming		
	<p><b>EN</b> ● Dimmable with TRIAC phase-cut dimmers (trailing edge).</p> <p><b>IT</b> ● Dimmerabile con variatore a taglio di fase TRIAC.</p>	
		<p><b>EN</b> ● Dimmable with DALI dimmers.</p> <p><b>IT</b> ● Dimmerabile con dimmer DALI.</p>
		
		<p><b>EN</b> ● Controllable with DALI dimmers (non included).</p> <p><b>IT</b> ● Controllabile con dimmer DALI (non inclusi).</p>
	<p><b>EN</b> ● Dimmer on the cord included.</p> <p><b>IT</b> ● Dimmer sul cavo incluso.</p>	
		<p><b>EN</b> ● Dim-to-Warm integrated dimmer.</p> <p><b>IT</b> ● Dim-to-Warm dimmer integrato.</p>
		
		<p><b>EN</b> ● Touch integrated dimmer.</p> <p><b>IT</b> ● Touch dimmer integrato.</p>

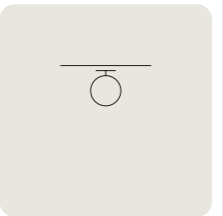
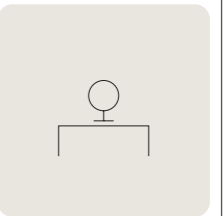
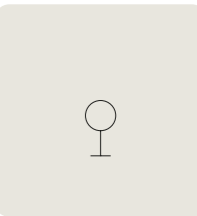
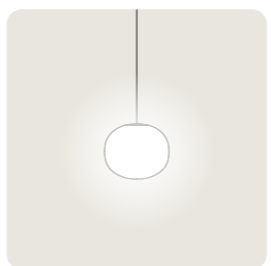
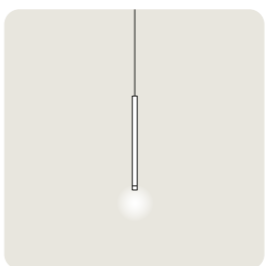
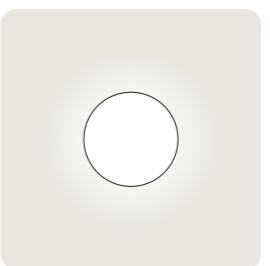
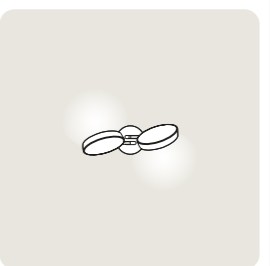
EU Energetic Label					
	<p><b>EN</b> ● Energy efficiency classes (with a scale from A to G). It indicates the Energy efficiency class of a product.</p> <p><b>IT</b> ● Classi di efficienza energetica (con una scala da A a G). Indica la classe di efficienza energetica di un prodotto.</p>				
Voltage					
	<p><b>EN</b> ● Voltage of the lamp.</p> <p><b>IT</b> ● Tensione dell'apparecchio.</p>				
Category					
					
Cluster suspension Sospensione cluster	Suspension Sospensione	Wall Parete	Ceiling Soffitto	Table Tavolo	Floor Terra
Type of light					
					
Diffused light Luce diffusa	Symmetrical diffused light Luce simmetrica diffusa	Indirect light Luce indiretta	Adjustable Orientabile		



## Ecodesign Regulation

**1**

**EN** The LED-only light source contained in this fixture must only be replaced by the manufacturer, its support service or similarly qualified personnel.

**IT** La sorgente luminosa, esclusivamente LED, contenuta in questo apparecchio deve essere sostituita solo dal costruttore o dal suo servizio di assistenza o da personale altrettanto qualificato.

**2**

**EN** The LED driver contained in this fixture must only be replaced by the manufacturer, its support service or similarly qualified personnel.

**IT** Il driver LED contenuto in questo apparecchio deve essere sostituito solo dal costruttore o dal suo servizio di assistenza o da personale altrettanto qualificato.

PAGE	TECH. INFO	PRODUCT NAME	CATEGORY	KELVIN	ENERGY CLASS	ECODESIGN	
P. 226	P. 246	A-Tube Nano	Cluster suspension lamp	2700 K 3000 K	D	1	2
P. 226	P. 248	A-Tube Nano Swing	Recessed ceiling lamp	2700 K 3000 K	D	1	2
P. 250	P. 259	A-Tube Nano Duo	Cluster suspension lamp	2700 K	D	1	2
P. 426	P. 431	Aile	Wall lamp	2700 K 3000 K	E	1	
P. 444	P. 449	Blow	Table lamp	2700 K	C	1	2
P. 406	P. 412	Bugia	Ceiling lamp	2700 K 3000 K	F	1	
P. 306	P. 317	Cono di Luce	Cluster suspension lamp, Table lamp	2700 K	B	1	2
P. 458	P. 463	Croma	Floor lamp	FROM 2200 K TO 3200 K	E	1	2
P. 450	P. 457	Easy Peasy	Cordless table lamp	FROM 2200 K TO 2700 K	D	1	
P. 052	P. 061	Elara	Suspension lamp	2700 K	D + E	1	2
P. 052	P. 061	Elara	Suspension lamp	3000 K	D + F	1	2
P. 434	P. 443	Hover	Floor lamp, Table lamp	2700 K	C	1	
P. 270	P. 282	IVY	Cluster suspension lamp, Suspension lamp, Central cluster suspension lamp	2700 K	D	1	2
P. 270	P. 282	IVY	Cluster suspension lamp, Suspension lamp, Central cluster suspension lamp	3000 K	C	1	2
P. 188	P. 197	Jefferson	Cluster suspension lamp	2700 K	D	1	2
P. 296	P. 305	Kelly Cluster	Cluster suspension lamp	2700 K	C	1	2
P. 420	P. 425	Laser	Wall lamp	2700 K 3000 K	E	1	
P. 360	P. 375	Nautilus	Wall lamp	2700 K 3000 K	F	1	
P. 360	P. 375	Nautilus Dim-to-Warm	Wall lamp	FROM 2200 K TO 2700 K	E	1	2
P. 360	P. 376	Nautilus Mini	Wall lamp	2700 K 3000 K	G	1	
P. 360	P. 376	Nautilus	Ceiling lamp	2700 K 3000 K	F	1	
P. 360	P. 377	Nautilus Spot	Ceiling lamp	2700 K 3000 K	F	1	
P. 174	P. 186	Nostalgia	Cluster suspension lamp	2700 K	C	1	2
P. 090	P. 102	Oblò	Cluster suspension lamp	2700 K 3000 K	D	1	2
P. 414	P. 419	Pin-Up	Wall lamp, Ceiling lamp	2700 K 3000 K	E	1	
P. 388	P. 393	Puzzle	Wall lamp, Ceiling lamp	2700 K 3000 K	E	1	
P. 394	P. 403	Puzzle Mega	Wall lamp, Ceiling lamp	2700 K 3000 K	C	1	2
P. 378	P. 387	Puzzle Round	Wall lamp, Ceiling lamp	2700 K 3000 K	E	1	
P. 214	P. 225	Rain	Cluster suspension lamp	2700 K 3000 K	C	1	2
P. 124	P. 143	Random	Cluster suspension lamp	2700 K 3000 K	D	1	2
P. 038	P. 048	Random Cloud	Suspension lamp	2700 K 3000 K	D	1	2
P. 104	P. 121	Random Solo 10, 12, 14, 18	Cluster suspension lamp	2700 K 3000 K	D	1	2
P. 104	P. 123	Random Solo 23, 28	Cluster suspension lamp	2700 K 3000 K	D	1	2
P. 020	P. 032	Random Stick	Suspension lamp	2700 K 3000 K	D	1	2
P. 020	P. 032	Random Stick	Suspension lamp	2700 K 3000 K	D	1	2
P. 350	P. 359	Shift	Wall lamp	2700 K 3000 K	D	1	2
P. 350	P. 359	Shift	Wall lamp	2700 K 3000 K	D	1	2
P. 062	P. 073	Sky-Fall	Suspension lamp	2700 K 3000 K	E	1	2
P. 062	P. 074	Sky-Fall Round	Suspension lamp	2700 K 3000 K	E	1	2
P. 198	P. 213	Spider	Cluster suspension lamp	2700 K 3000 K	C	1	2
P. 198	P. 213	Spider	Ceiling lamp	2700 K 3000 K	F	1	
P. 330	P. 347	Tidal	Suspension lamp	2700 K 3000 K	C	1	2
P. 330	P. 348	Tidal	Ceiling lamp	2700 K 3000 K	C	1	2
P. 330	P. 348	Tidal 60	Ceiling lamp	2700 K 3000 K	C	1	2
P. 330	P. 349	Tidal 75	Ceiling lamp	2700 K 3000 K	B	1	2
P. 260	P. 268	A-Tube	Suspension lamp, Ceiling lamp				
P. 284	P. 294	JIM	Cluster suspension lamp, Suspension lamp				
P. 076	P. 086	Kelly dome	Suspension lamp				
P. 076	P. 087	Kelly sphere	Suspension lamp				
P. 144	P. 168	Volum	Cluster suspension lamp, Suspension lamp, Wall lamp, Ceiling lamp, Table lamp, Floor lamp				

## DALI/PUSH to TRIAC Signal Converter

CATEGORY ACCESSORY

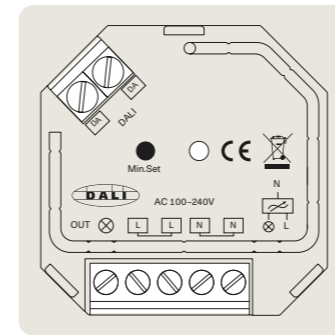

Description Descrizione	DALI Consumption Consumo DALI	Sizes Dimensioni		Code Codice
Input Voltage 100-240 VAC	2 mA max	Length	45,5 mm	999A02 00
Output Voltage 100-240 VAC		Width	45 mm	
Output Current 1,8 A max		Height	20,3 mm	

PAGE	TECH. INFO	PRODUCT NAME	CATEGORY	MAX CONNECTABLE PRODUCTS TO ONE CONVERTER
P. 226	P. 246	A-Tube Nano, A-Tube Nano Swing	Cluster suspension lamp, Ceiling lamp	25
P. 250	P. 259	A-Tube Nano Duo	Cluster suspension lamp	25
P. 426	P. 431	Aile	Wall lamp	12
P. 406	P. 412	Bugia Single	Ceiling lamp	13
P. 406	P. 412	Bugia Double	Ceiling lamp	6
P. 406	P. 413	Bugia Triple	Ceiling lamp	4
P. 406	P. 413	Bugia Mega	Ceiling lamp	4
P. 306	P. 317	Cono di Luce	Cluster suspension lamp, Table lamp	20
P. 052	P. 061	Elara	Suspension lamp	6
P. 270	P. 282	IVY	Cluster suspension lamp, Suspension lamp, Central cluster suspension lamp	25
P. 188	P. 197	Jefferson	Cluster suspension lamp	25
P. 296	P. 305	Kelly Cluster	Cluster suspension lamp	18
P. 420	P. 425	Laser	Wall lamp	12
P. 360	P. 375	Nautilus, Nautilus Dim-to-Warm	Wall lamp	8
P. 360	P. 376	Nautilus Mini	Wall lamp	16
P. 360	P. 376	Nautilus	Ceiling lamp	16
P. 360	P. 377	Nautilus Spot	Ceiling lamp	20
P. 174	P. 186	Nostalgia	Cluster suspension lamp	11
P. 090	P. 102	Oblò	Cluster suspension lamp	18
P. 414	P. 419	Pin-Up	Wall lamp, Ceiling lamp	25
P. 388	P. 393	Puzzle, Puzzle Round single	Wall lamp, Ceiling lamp	12
P. 388, 378	P. 393, 387	Puzzle, Puzze Round double	Wall lamp, Ceiling lamp	6
P. 388	P. 393	Puzzle square & rectangle	Wall lamp, Ceiling lamp	6
P. 394	P. 403	Puzzle Mega large	Wall lamp, Ceiling lamp	5
P. 394	P. 403	Puzzle Mega small	Wall lamp, Ceiling lamp	6
P. 214	P. 225	Rain	Cluster suspension lamp	11
P. 124	P. 143	Random	Cluster suspension lamp	25
P. 038	P. 048	Random Cloud	Suspension lamp	1
P. 104	P. 121	Random Solo 10, 12, 14, 18	Cluster suspension lamp	25
P. 104	P. 123	Random Solo 23, 28	Cluster suspension lamp	25
P. 020	P. 032	Random Stick short	Suspension lamp	11
P. 020	P. 034	Random Stick long	Suspension lamp	9
P. 350	P. 359	Shift small	Wall lamp	9
P. 350	P. 359	Shift large	Wall lamp	5
P. 062	P. 073	Sky-Fall, Sky-Fall Round	Suspension lamp	14
P. 198	P. 213	Spider	Cluster suspension lamp	11
P. 198	P. 213	Spider	Ceiling lamp	20
P. 330	P. 347	Tidal	Suspension lamp	4
P. 330	P. 348	Tidal 45	Ceiling lamp	6
P. 330	P. 348	Tidal 60	Ceiling lamp	4
P. 330	P. 349	Tidal 75	Ceiling lamp	3
P. 260	P. 268	A-Tube	Suspension lamp, Ceiling lamp	
P. 284	P. 294	JIM	Cluster suspension lamp, Suspension lamp	
P. 076	P. 086	Kelly dome	Suspension lamp	
P. 076	P. 087	Kelly sphere	Suspension lamp	
P. 144	P. 168	Volum	Cluster suspension lamp, Suspension lamp, Wall lamp, Ceiling lamp, Table lamp, Floor lamp	

The wattage of retrofit LED bulbs must not exceed 200W. Make sure to install only dimmable bulbs.

La potenza delle lampadine LED retrofit non deve superare i 200W. Assicurarsi di montare solo lampadine dimmerabili.

Extended dimming solutions for low-voltage products (not included)  
Soluzioni di dimmerazione estese per prodotti a bassa tensione (non incluso)

PRODUCT NAME	DRIVER V <sub>F</sub> (V)	DRIVER OPERATIONAL (mA)	LED POWER (W)	SUGGESTED DRIVER	MAX PRODUCTS SERIES WIRING	DRIVER POSITION	TYPE OF DIMMING
Kelly Cluster							
Nostalgia							
Oblò	20	350 max	6,9	TCI Meanwell Meanwell	2 4 4	Remote	DALI-PUSH DALI-PUSH CASAMBI-PUSH
Rain							
Spider - Cluster suspension lamp							
Random Solo 12							
Random Solo 14	3	350 max	1	TCI Meanwell Meanwell	18 32 32	Remote	DALI-PUSH DALI-PUSH CASAMBI-PUSH
Random Solo 18							
A-Tube Nano Duo	6	350 max	2	TCI Meanwell Meanwell	9 16 16	Remote	DALI-PUSH DALI-PUSH CASAMBI-PUSH
A-Tube Nano							
IVY							
Jefferson	9	350 max	3	TCI Meanwell Meanwell	6 10 10	Remote	DALI-PUSH DALI-PUSH CASAMBI-PUSH
Random Solo 23							
Random Solo 28							
Random	9	350 max	3	TCI Meanwell Meanwell	6 10 10	Remote	DALI-PUSH DALI-PUSH CASAMBI-PUSH
Elara	26,8	1050 max	28,1	KGP TCI	1 1	Canopy	DALI-PUSH DALI-PUSH
Tidal 45	24	550 max	27	KGP	1	Built-in	DALI-PUSH
Tidal 60	46	600 max	28	DIRECT TCI ERP	1	Built-in	DALI-PUSH DALI
Tidal 60	24	350 max	9	INDIRECT KGP EUCHIPS	1	Built-in	DALI-PUSH DALI-PUSH
Tidal 75	46	700 max	33	DIRECT TCI ERP	1	Built-in	DALI-PUSH DALI
Tidal 75	24	550 max	13	INDIRECT KGP EUCHIPS	1	Built-in	DALI-PUSH DALI-PUSH
Puzzle Mega Round small Puzzle Mega Square small	46	550 max	25	TCI ERP	1	Remote	DALI-PUSH DALI
Puzzle Mega Round large Puzzle Mega Square large	46	700 max	33	TCI ERP	1	Remote	DALI-PUSH DALI
Random Stick short	30	350 max	10,5	EUCHIPS	1	Canopy	DALI-PUSH
Random Stick long	45	350 max	15,7	EUCHIPS	1	Canopy	DALI-PUSH

► The suggested drivers are compatible with our lamps but not included. Lodes does not assume any responsibility/guarantee for their installation.

► I driver proposti sono compatibili con le nostre lampade ma non inclusi nelle certificazioni. Lodes non si assume nessuna responsabilità/garanzia sulla loro installazione.

Light sources power  
Potenza fonti luminose

PAGE	TECH. INFO	PRODUCT NAME	CATEGORY	TOTAL POWER DRAW	LED QUANTITY & POWER	TOTAL LED POWER
P. 226	P. 246	A-Tube Nano	Cluster suspension lamp	5 w	1 × 3 w	3 w
P. 226	P. 248	A-Tube Nano Swing	Recessed ceiling lamp	5 w	1 × 3 w	3 w
P. 250	P. 259	A-Tube Nano Duo	Cluster suspension lamp	4 w	2 × 1 w	2 w
P. 426	P. 431	Aile	Wall lamp	16 w	2 × 8 w	16 w
P. 444	P. 449	Blow	Table lamp	4,5 w	1 × 4,5 w	4,5 w
P. 406	P. 412	Bugia Single	Ceiling lamp	15 w	1 × 15 w	15 w
P. 406	P. 412	Bugia Double	Ceiling lamp	30 w	2 × 15 w	30 w
P. 406	P. 413	Bugia Triple	Ceiling lamp	45 w	3 × 15 w	45 w
P. 406	P. 413	Bugia Mega	Ceiling lamp	45 w	3 × 15 w	45 w
P. 306	P. 317	Cono di Luce	Cluster suspension lamp	10 w	1 × 7 w	7 w
P. 306	P. 317	Cono di Luce	Table lamp	7,5 w	1 × 7,5 w	7,5 w
P. 458	P. 463	Croma	Floor lamp	42 w	1 × 42 w	42 w
P. 450	P. 457	Easy Peasy	Cordless table lamp	5 w	1 × 5 w	5 w
P. 052	P. 061	Elara	Suspension lamp	32 w	18 w + 9 w	27 w
P. 434	P. 443	Hover	Floor lamp, Table lamp	6,5 w	1 × 6,5 w	6,5 w
P. 270	P. 282	IVY	Cluster suspension lamp, Suspension lamp, Central cluster suspension lamp	5 w	1 × 3 w	3 w
P. 188	P. 197	Jefferson	Cluster suspension lamp	5 w	1 × 3 w	3 w
P. 284	P. 294	JIM	Cluster suspension lamp, Suspension lamp	25 w		
P. 296	P. 305	Kelly Cluster	Cluster suspension lamp	11 w	1 × 7 w	7 w
P. 420	P. 425	Laser	Wall lamp, Ceiling lamp	16 w	1 × 16 w	16 w
P. 360	P. 375	Nautilus Dim-to-Warm	Wall lamp	22 w	2 × 7 w	14 w
P. 360	P. 375	Nautilus	Wall lamp	24 w	2 × 12 w	24 w
P. 360	P. 376	Nautilus Mini	Wall lamp	12 w	1 × 12 w	12 w
P. 360	P. 376	Nautilus	Ceiling lamp	12 w	1 × 12 w	12 w
P. 360	P. 377	Nautilus Spot	Ceiling lamp	10 w	1 × 10 w	10 w
P. 174	P. 186	Nostalgia	Cluster suspension lamp	11 w	1 × 7 w	7 w
P. 090	P. 102	Oblò	Cluster suspension lamp	11 w	1 × 7 w	7 w
P. 414	P. 419	Pin-Up	Wall lamp, Ceiling lamp	8 w	1 × 8 w	8 w
P. 388	P. 393	Puzzle single square	Wall lamp, Ceiling lamp	16 w	1 × 16 w	16 w
P. 388	P. 393	Puzzle double square	Wall lamp, Ceiling lamp	32 w	2 × 16 w	32 w
P. 388	P. 393	Puzzle square & rectangle	Wall lamp, Ceiling lamp	32 w	2 × 16 w	32 w
P. 378	P. 387	Puzzle Round single	Wall lamp, Ceiling lamp	16 w	1 × 16 w	16 w
P. 378	P. 387	Puzzle Round double	Wall lamp, Ceiling lamp	32 w	2 × 16 w	32 w
P. 394	P. 403	Puzzle Mega small	Wall lamp, Ceiling lamp	30 w	3 × 8 w	25 w
P. 394	P. 403	Puzzle Mega large	Wall lamp, Ceiling lamp	38 w	4 × 8 w	33 w
P. 214	P. 225	Rain	Cluster suspension lamp	11 w	1 × 7 w	7 w
P. 124	P. 143	Random	Cluster suspension lamp	5 w	3 × 1 w	3 w
P. 038	P. 048	Random Cloud 7 Lights	Suspension lamp	35 w	7 × 3 w	21 w
P. 038	P. 049	Random Cloud 14 Lights	Suspension lamp	70 w	14 × 3 w	42 w
P. 038	P. 050	Random Cloud 19 Lights	Suspension lamp	95 w	19 × 3 w	57 w
P. 038	P. 051	Random Cloud 23 Lights	Suspension lamp	115 w	23 × 3 w	69 w
P. 104	P. 121	Random Solo 10, 12, 14, 18	Cluster suspension lamp	3 w	1 × 1 w	1 w
P. 104	P. 123	Random Solo 23, 28	Cluster suspension lamp	5 w	1 × 3 w	3 w
P. 020	P. 032	Random Stick short	Suspension lamp	17,5 w	3 × 2 w + 4 × 1 w	10 w
P. 020	P. 034	Random Stick long	Suspension lamp	22 w	3 × 3 w + 6 × 1 w	15 w
P. 350	P. 359	Shift small	Wall lamp	19,5 w	1 × 16 w	16 w
P. 350	P. 359	Shift large	Wall lamp	36 w	1 × 32,5 w	32,5 w
P. 062	P. 073	Sky-Fall, Sky-Fall Round	Suspension lamp	20 w	2 × 8,5 w	17 w
P. 198	P. 213	Spider	Cluster suspension lamp	11 w	1 × 11 w	11 w
P. 198	P. 213	Spider	Ceiling lamp	10 w	1 × 10 w	10 w
P. 330	P. 347	Tidal	Suspension lamp	40 w	16,5 w + 16,5 w	33 w
P. 330	P. 348	Tidal 45	Ceiling lamp	30 w	27 w	27 w
P. 330	P. 348	Tidal 60	Ceiling lamp	48 w	28 w + 9 w	37 w
P. 330	P. 349	Tidal 75	Ceiling lamp	55 w	33 w + 13 w	46 w



**Art. 1 Recital**  
Unless otherwise provided for in a separate written agreement between the parties, every sale of products of Lodes S.r.l., VAT 02992370276 (hereinafter, “the Seller”) is governed by the following General Conditions of Sale that must be considered as an essential part of this agreement and shall be deemed to have been accepted by the Buyer even though the latter has not signed them. Any clause unilaterally added by the Buyer in the documentation signed by it and /or in its correspondence, being against or in any case in addition to the general conditions or to those specific expressly approved in writing by the Seller, shall be deemed as not written and shall be of no effect.

**Art. 2 Completion of the sale, quantities and prices**

The sale is deemed to be completed once the Seller gives the written order confirmation also by fax and / or email or when deliveries are commenced in cases where the immediate delivery of the supply is requested, also in consideration of changes occurred and then accepted by the customer. The prices agreed are understood for products delivered ex works of the Seller and do not include services and accessory charges (such as VAT, special packaging, transport and installation costs, and /or assemblages and so on).

**Art. 3 Delivery, risk transfer and transport**  
Products are delivered to the Buyer at the Seller's plant or at another place indicated in writing by the Seller, and the risk transfer takes place with the delivery of the goods to the first carrier or Buyer in the events of collection of goods directly carried out by the latter. The products always travel at the Buyer's sole risk also when the carrier is selected and appointed by the Seller, being the latter freed from all responsibilities after having delivered the products to the carrier, this delivery is deemed to all effects being carried out directly by the said Buyer. The delivery terms agreed are to be understood as indicative. If the Seller is responsible for delay of delivery for a period of up to 60 days, the Buyer is not entitled either to refuse the supply or to request the termination of the agreement and /or the compensation for any damages. If the delay in delivery exceeds 60 days, the Buyer is entitled to request – by registered letter – the cancellation of the order and the reimbursement of the advances if paid. In any event, the Seller shall not be liable for and /or direct and indirect damages of any nature and for any reason due to the delay or the failure to carry out the supply.

**Art. 4 Reservation of title**  
he Buyer acquires property rights over the goods with the full payment of the price invoiced of the supplies but it takes the risks thereof as of the delivery.

**Art. 5 Products features and conditions of use**

Unless otherwise expressly agreed in writing by the parties, the conditions for using of the products are those communicated or in any case resulting from the drawings and technical specifications of the Seller, if any, or as described in the website [www.lodes.com](http://www.lodes.com) in relation to products. The quality levels of products are the standard quality levels of the Sellers, indicated in the relevant specifications as described on the Seller's website. It is always the Buyer's responsibility to identify and notify the Seller of the conditions of use of products before technically defining them. Failing any particular instructions from the Buyer, the Seller considers as usual conditions of use those it considered or described in its designs and technical documentation. Drawings, materials, and colours of the products included in catalogues/website and more generally in all advertising material are indicative. The Seller reserves the right, without notice, to modify the characteristics of its products, as well as their availability. Technical data, images, and information regarding the products are not binding on the Seller, who will not be held responsible for any discrepancies and / or illustrative and / or textual errors. Further product characteristics are contained in the respective technical sheets and /or instruction sheets.

**Art. 6 Warranties**  
The products delivered are covered by a warranty for defects in material and manufacture for a period of 24 months as of the delivery if the Buyer is a natural person, otherwise the warranty period will be of 12 months as of the delivery. The Seller shall replace the products delivered in this warranty period being faulty due to factory defects or in alternative, at its discretion, pay the Buyer an amount equal to the price already invoiced of the said products, being expressly excluded and waived any other right or claim by the Buyer also as compensation for direct and /or indirect damages or cost repayment borne by it (such as recovery, technical assistance, recalling costs, etc.). The Seller will anticipate the delivery of the replaced product, invoicing it regularly. Successively, when the product arrives to the Seller's warehouse, the latter will credit the amount of the defective product. The transport's costs will be paid by the Seller. Should the defected item be returned in an inadequate non-original packaging, with damages connected to the transport, The Seller will not credit any amount to the Buyer, and it will return the product to the sender at his own expenses. If the replacement was made for alleged defects in material and manufacture, but after the control carried out by the Seller, it is considered (i) unfounded, due to the absence of defects; (ii) further damaged by insufficient packaging in the return transport (iii) spoiled by tampering made by the Buyer, all transportation costs and the entire value of the product will be charged to the latter. Any defectiveness or non-compliance of products shall be reported by the Buyer by writing to the Seller – in order to be valid – within 8 days from receipt of goods; any hidden defects shall be reported by the Buyer by writing to the Seller – always in order to be valid – within 8 days as of the relevant discovery. It being understood that the Seller will not be responsible for any defect even though hidden, being notified in writing, after 24 months of the delivery of goods. The warranty does not apply where the defects identified are due to the Buyer's negligence and /or to the use of products being not compliant with the information and explanations in any case gave by the Seller, technical provisions, to incorrect design, application, assembly or manufacture of the facilities in which they are installed, to incorrect maintenance carried out by unauthorized personnel, to improper cleaning since it is made with materials and manners being not suitable, to incorrect storage, handling and transport, to improper or imprudent use, also in the event of electrical system and its capacity being not suitable, or to circumstances that in any case cannot be related to the production defectiveness by the Seller. Every single product of the Seller corresponds to the mark laid down by the European Community with Directive 93 / 68 (extension of Directive 73 / 23) to confirm, with a mark recognized all over Europe, that the lights have undergone the electrical safety test required by European standards EN-60598-1-2 II ed. + CEI EN 60598-1 IV ed. corresponding to Italian standards CEI 34-21 + CEI 34-23, electrical safety standards referred to by all institutions, including the IMQ. The products indicated with the logo UL and /or ETL corresponds to the standards UL 1598 /CAN /USA C22.2 No.250.0 o UL 153.

**Art. 7 Buyer's Obligations**  
The Buyer is required to immediately take delivery of the goods given by the Seller to the carrier, or – where otherwise agreed – to timely collect them at the Seller's plant on the date on which the Seller communicates, by any means, that the goods are ready. Where the Buyer delays the collection of the production for a period exceeding 10 days, in addition to the payment of price it shall pay the Seller a proper compensation equal to 2% per day of the price invoiced for storing such products. The Buyer shall carry out the payments normally, in accordance with the terms and conditions specified in the invoice. For late payments it will be accrued by default without need of further notification interest under Legislative Decree no. 231 / 2002. In the event of payment delays, the Seller is entitled to immediately suspend any supply, even though it has concluded other agreements with the same Buyer. The failure to pay within the terms agreed will cause in any event the loss of favourable terms for the Buyer.

**Art. 8 Replacement of the Product**  
If a product is returned for commercial reasons or for a mistake in the order made by the Buyer, the Seller will retain an amount equal to the 20% of the total price as cost for reconditioning the product. If the returned product had already been used and / or it has been returned in an inadequate original packaging, with consequent transport damages, the Seller will not credit to the Buyer any amount and it will return the product to the sender at his own expenses. Only the articles in the catalogue and in the price list in force at the time of the request will be taken into consideration. Transport's costs are always charged to the Buyer. The repair of damaged products will be authorized only if the damage has been caused by the Buyer. The Buyer, once accepted repair costs, will take care of returning the damaged product to the Seller's warehouse and it will pay the costs of transporting the repaired product.

**Art. 9 Force majeure**  
If the Seller is unable to comply with the agreement due to force majeure or beyond its control events, the deadlines set for the supply are automatically extended for a period in which these effects continue. Where the obstacle to comply with the agreement is longer than 6 months, both parties may request the termination of the agreement and, in such event, the Seller repay the Buyer the advances received, if any, releasing itself from any additional obligation on it.

**Art. 10 Agreement**  
In the event of execution of a specific agreement signed by the parties, the said agreement together with its Annexes provides for and summarizes the obligations validly undertaken by the parties and being binding for them. The fulfilment by the parties will be subject to effective evaluation of the actual performance of the contractual tasks and duties to be carried out in good faith, with honesty and fairness. These General Conditions of Sale shall apply to the agreement, unless otherwise provided in writing by the parties or expressly provided in the said agreement.

**Art. 11 Privacy Policy**  
The Seller will use the data received from the Buyer in accordance with the provisions of the article 13 of EU Regulation 2016 /679 of 27 April 2016 (GDPR). For more information are available at the following link: [www.lodes.com/privacy-policy](http://www.lodes.com/privacy-policy).

**Art. 12 Disputes**  
Any dispute which may arise concerning the signing, validity, interpretation, performance, amendment and termination of the agreement or of these General Conditions of Sale will be settled according to principles and rule set forth in Article 13 below.

**Art. 13 Jurisdiction and Applicable Law**  
The Court of Milan, Italy, shall be held exclusively competent, being any other court of competent jurisdiction expressly excluded, and the Italian Law shall be applicable.

**Art. 14 Website**  
These General Conditions of Sale are those indicated on the website [www.lodes.com](http://www.lodes.com) and may be printed and reproduced on paper. The Seller undertakes to update the website [www.lodes.com](http://www.lodes.com) by publishing on it the version of the General Conditions of Sale as amended from time to time.

**Art. 1 Premessa**  
Salvo deroga risultante da apposito accordo scritto tra le parti, ogni compravendita di prodotti di Lodes S.r.l., P.IVA 02992370276 (di seguito: “Venditore”) è regolata dalle seguenti Condizioni Generali di Vendita che costituiscono parte essenziale del contratto e che si intendono pertanto accettate dal Compratore ancorché dallo stesso non sottoscritte. Qualsiasi clausola unilateralmente apposta dal Compratore nei documenti da lui sottoscritti e/o nella sua corrispondenza, che sia contraria o comunque in aggiunta alle seguenti condizioni generali od a quelle speciali espressamente approvate per iscritto dal Venditore, si intende come non scritta ed è priva di ogni effetto.

**Art. 2 Perfezionamento della compravendita, quantitativi e prezzi**

La compravendita si intende perfezionata con la conferma d'ordine scritta del Venditore anche a mezzo fax e/o posta elettronica o con l'inizio delle consegne per i casi in cui è stata richiesta l'immediata consegna della fornitura anche in presenza di modifiche intervenute e quindi accettate dal cliente. I prezzi concordati si intendono per prodotti consegnati franco stabilimento del Venditore e non comprendono prestazioni ed oneri accessori (quali IVA, imballo speciale, spese di trasporto, di installazione e/o montaggi e così via).

**Art. 3 Consegna, trasferimento del rischio e trasporto**

La merce viene consegnata al Compratore presso lo stabilimento del Venditore o in altro sito dallo stesso indicato per iscritto, ed il trasferimento del rischio avviene con la consegna della stessa al primo vettore o al Compratore nelle ipotesi di ritiro della merce da quest'ultimo direttamente eseguita. La merce viaggia sempre a rischio esclusivo del Compratore anche quando il vettore dovesse essere scelto ed incaricato dal Venditore, essendo quest'ultimo liberato da ogni responsabilità con la consegna dei prodotti al vettore, che ad ogni effetto si intende eseguita a mani dallo stesso Compratore. I termini di consegna pattuiti si intendono indicativi. In caso di ritardo nella consegna imputabile al Venditore per un periodo fino a 60 gg il Compratore non ha il diritto di rifiutare la fornitura, né di richiedere la risoluzione del contratto e/o il risarcimento di alcun danno. Se il ritardo nella consegna supera il termine di 60 gg il Compratore ha la facoltà di richiedere – con lettera raccomandata – l'annullamento dell'ordine e la restituzione degli anticipi eventualmente versati. Resta in ogni caso escluso qualsivoglia obbligo del Venditore di risarcimento danni diretti e/o indiretti di qualsiasi natura e per qualsiasi ragione, in dipendenza del ritardo ovvero della mancata esecuzione della fornitura.

**Art. 4 Riserva di proprietà**  
Il Compratore acquista la proprietà della merce solo con il pagamento integrale del prezzo fatturato delle forniture ma ne assume i rischi dal momento della consegna.

**Art. 5 Caratteristiche dei prodotti e condizioni di utilizzo**

Salvo diverso ed espresso accordo scritto tra le parti, i parametri funzionali dei prodotti sono quelli espressi comunicati o comunque risultanti nei disegni e specifiche tecniche del Venditore se esistenti o su quanto indicato sul sito web [www.lodes.com](http://www.lodes.com) relativamente ai prodotti. I livelli di qualità dei prodotti forniti sono quelli standard del Venditore, evidenziati nelle relative specifiche o su quanto indicato e desumibile sul sito web del Venditore. È onere del Compratore individuare e comunicare al Venditore le condizioni di utilizzo dei prodotti prima della relativa definizione tecnica. In mancanza di indicazioni da parte del Compratore il Venditore considera condizioni di utilizzo quelle di prassi dallo stesso considerate o esplicitate nei propri disegni e documentazione tecnica. I disegni, i materiali ed i colori dei prodotti inseriti sui cataloghi/sito internet e più in generale in tutto il materiale pubblicitario, si intendono a titolo indicativo. Il Venditore, si riserva il diritto, senza alcun preavviso, di modificare le caratteristiche dei propri prodotti,

così come la disponibilità degli stessi. I dati tecnici, le immagini e le informazioni riguardo ai prodotti non sono vincolanti per il Venditore, il quale non risponderà per eventuali difformità e/o errori illustrativi e/o testuali. Ulteriori caratteristiche dei prodotti sono contenute nelle relative schede tecniche e/o fogli di istruzione.

**Art. 6 Garanzie**

I prodotti forniti sono coperti da garanzia per difetti di materiale e/o fabbricazione per un periodo di 24 mesi dalla consegna se il Compratore risulta essere una persona fisica, diversamente il periodo di garanzia sarà di 12 mesi dalla consegna. Il Venditore sostituisce i prodotti resi in detto periodo di garanzia e riconosciuti difettosi per vizi d'origine ovvero in alternativa ed a sua scelta accredita al Compratore una somma pari al prezzo già fatturato dei prodotti stessi, restando espressamente escluso e rinunciato qualsiasi diverso diritto o pretesa del Compratore anche a titolo di risarcimento danni diretti e/o indiretti o di rimborso di costi dallo stesso sostenuti (quali costo di riprese, di assistenza tecnica, di richiamo, ecc.). Il Venditore anticiperà l'invio del prodotto in sostituzione, fatturandolo regolarmente, andando poi ad accreditare l'importo alla riconsegna del prodotto difettoso reso. Le spese di trasporto saranno a carico del Venditore. Qualora l'articolo oggetto del reso venisse riconsegnato in un imballo non originale inadeguato con conseguenti danni da trasporto, il Venditore non accrediterà al Compratore alcun importo e rinvierà al mittente, a sue spese il prodotto. Qualora il reso venisse effettuato per presunti vizi d'origine ma dopo il controllo effettuato dal Venditore lo stesso venisse ritenuto (i) infondato, per assenza di vizi; (ii) ulteriormente danneggiato da insufficiente imballaggio nel trasporto di ritorno (iii) viziato da manomissione posta in essere dal Compratore, verranno addebitati a quest'ultimo tutti i costi di trasporto nonché l'intero valore del prodotto. Eventuali difettosità o non conformità dei prodotti devono essere segnalate dal Compratore per iscritto al Venditore – a pena di decadenza – entro e non oltre 8 gg dalla data di ricevimento della merce; eventuali difetti occulti devono essere segnalati dal Compratore per iscritto al Venditore – sempre a pena di decadenza – entro 8 gg dalla relativa scoperta. Resta inteso che il Venditore non sarà responsabile per alcun vizio ancorché occulto, comunicato per iscritto, oltre 24 mesi dalla consegna della merce. La garanzia non opera ove i difetti rilevati siano imputabili a negligenza del Compratore e/o ad impiego dei prodotti non conforme con le informazioni e le spiegazioni in ogni caso fornite dal Venditore, alle prescrizioni tecniche, ad errata progettazione, applicazione, montaggio o fabbricazione delle strutture ove sono installati, ad errata manutenzione operata da personale non autorizzato, a pulizia impropria in quanto effettuata con modalità o materiali non idonei, ad errato magazzino, movimentazione e trasporto, ad uso improprio od incauto, anche in caso di impianto elettrico e portata dello stesso non idonea, ovvero a circostanze che comunque non possono ricollegarsi a difettosità di produzione da parte del Venditore. Ogni singolo prodotto del Venditore è conforme alla marcatura richiesta dalla Comunità Europea con la direttiva 93/68 (ampliamento della direttiva 73/23) per confermare con una marcatura riconosciuta in tutta Europa, che le lampade sono state sottoposte alle prove di sicurezza elettrica richieste dalle norme Europee EN-60598-1-2 II ed. + CEI EN 60598-1 IV ed. corrispondenti norme italiane CEI 34-21 + CEI 34-23, norme per la sicurezza elettrica a cui fanno riferimento tutti gli istituti, compreso l'IMQ. I prodotti indicati con il marchio UL e/o ETL sono conformi alla normativa UL 1598 /CAN /USA C22.2 No.250.0 o UL 153.

**Art. 7 Obblighi del Compratore**  
Il Compratore è tenuto a prendere immediatamente in consegna i prodotti affidati dal Venditore al vettore, ovvero – se diversamente concordato – apuntualmente ritirarli presso lo stabilimento del Venditore alla data di comunicazione di merce pronta che potrà avvenire con ogni mezzo da parte del Venditore. Ove il Compratore ritardi il ritiro dei prodotti per un periodo superiore a 10 gg, oltre al pagamento del prezzo deve corrispondere al Venditore un adeguato compenso pari al 2% al giorno dell'importo fatturato per il magazzino

degli stessi. Il Compratore deve effettuare i pagamenti normalmente, con le modalità e nei termini precisati in fattura. Sui ritardati pagamenti decorreranno, di pieno diritto e senza necessità di costituzione in mora, gli interessi di cui al D.lgs. n. 231 /2002. In caso di ritardo dei pagamenti il Venditore ha diritto a sospendere immediatamente ogni fornitura, anche se dipendente da altri contratti con lo stesso Compratore. Il mancato pagamento nei termini pattuiti comporta in ogni caso la decadenza del Compratore dal beneficio del termine.

**Art. 8 Resi**

In caso di reso commerciale o in caso di reso per errore del Compratore, il Venditore tratterà un importo pari al 20% minimo del totale a titolo di costo di ricondizionamento dell'articolo. Qualora l'articolo oggetto del reso fosse già stato utilizzato e/o venisse riconsegnato in un imballo non originale inadeguato, con conseguenti danni da trasporto, il Venditore non accrediterà al Compratore nessun importo e rinvierà al mittente, a sue spese, il reso. Verranno presi in considerazione solamente gli articoli presenti nel catalogo e nel listino in vigore al momento della richiesta. Le spese di trasporto sono sempre a carico del Compratore. I resi per riparazione vanno autorizzati solo se la causa del danno è dipesa dal Compratore che dopo aver accettato il costo di riparazione si occuperà a proprie spese di rispedire l'articolo danneggiato in sede e si accollerà poi i costi relativi al trasporto del prodotto riparato.

**Art. 9 Forza maggiore**  
Qualora il Venditore sia impossibilitato a rispettare il contratto per cause di forza maggiore o comunque indipendenti dalla sua volontà, i termini previsti per l'esecuzione della fornitura sono automaticamente prorogati per un periodo equivalente al perdurare degli effetti di tali cause. Qualora la causa imputativa continui per più di 6 mesi entrambe le parti possono chiedere la risoluzione del contratto ed in tal caso il Venditore restituisce al Compratore gli anticipi eventualmente ricevuti, con esclusione di ogni e qualsiasi onere ulteriore a suo carico.

**Art. 10 Contratto**

In caso di sottoscrizione di apposito contratto lo stesso con i suoi allegati contiene e riassume le obbligazioni validamente assunte dalle parti e per esse vincolanti. L'adempimento delle parti sarà oggetto di valutazione dell'effettiva esecuzione dei compiti e doveri contrattuali, da effettuarsi in buona fede, onestà e con equità. Le presenti Condizioni Generali di Vendita si applicheranno al contratto salvo deroga risultante da atto scritto o in esso contratto esplicitamente prevista.

**Art. 11 Trattamento dei dati personali**  
Il Venditore utilizzerà i dati ricevuti dal Compratore conformemente alle disposizioni vigenti in materia di Privacy secondo l'art.13 del Regolamento Europeo 2016 /679 (GDPR). Maggiori informazioni sono disponibili al seguente link [www.lodes.com/it/privacy-policy](http://www.lodes.com/it/privacy-policy).

**Art. 12 Controversie**  
Qualora dovesse verificarsi una qualsivoglia controversia avente ad oggetto la formazione, validità, interpretazione, esecuzione, modifica e risoluzione del contratto o delle presenti Condizioni Generali di Vendita, questa sarà risolta secondo i principi e le regole indicate nell'articolo 13 che segue.

**Art. 13 Foro competente e legge applicabile**

Foro esclusivamente competente sarà quello di Milano con esplicita esclusione di ogni altro foro alternativamente competente, e la legge applicabile quella italiana.

**Art. 14 Sito web**  
Le presenti Condizioni Generali di Vendita, sono quelle risultanti sul sito web [www.lodes.com](http://www.lodes.com) e sono stampabili e riproducibili su supporto cartaceo. Il Venditore si impegna ad aggiornare il sito web [www.lodes.com](http://www.lodes.com) mediante la pubblicazione sullo stesso della versione di Condizioni Generali di Vendita di volta in volta modificata.



#### Head Offices & Showroom

Lodes – via Pialoi 32,  
30020 Marcon, Venice – Italy  
T +39 041 45 69 266  
General information  
info@lodes.com

Lodes USA LLC  
560 Springfield Avenue, Suite B  
Westfield, NJ 07090 – USA  
D 201 903 0020  
usa@lodes.com

Lodes' Hong Kong Office  
Unit 507 Arion Commercial  
Centre, 2–12 Queen's Road West  
Sheung Wan – Hong Kong

#### Lodes Milan Showroom

via della Moscova 33,  
Cortile della Seta  
20121 Milano (MI) – Italy  
T +39 02 4940 0999  
milano@lodes.com

#### Lodes Flagships

Lodes Paris – Novaluce  
131 rue du Faubourg  
Saint Honoré,  
75008 Paris 8e – France  
T +33 (0) 1 42 89 03 18  
paris@lodes.com

Lodes Cologne  
Design Post Köln  
Deutz-Mülheimer-Str. 22a  
50679 Köln – Germany

#### Lodes 2025 Collection Catalogue

Art direction  
and graphic design  
Multi Form

Images  
Bruger Studio

Operavisual  
(p. 021–031, 039, 046, 056,  
063, 077, 091, 094–101,  
125, 128, 150, 151, 156–160,  
199, 227, 240–245, 307,  
310, 331–337, 346, 351–358,  
435, 465)

Photography  
Mattia Balsamini  
(p. 003, 006–009)  
Maurizio Polese  
(p. 070, 118, 140, 183,  
210, 236, 254)  
Studio Pointer  
(p. 078, 134, 182, 192, 256,  
266, 368, 369, 382, 389,  
390, 391, 415, 416, 421, 422,  
445, 447)

Special projects  
Toby's Estate  
Project: Studio Neseff  
Ph: Mohammed Ashkanani  
(p. 114, 115)

Luminaire  
Project: Cavcorp  
Ph: Brock Beazley  
(p. 154, 155)

Marina One Residence  
Project: Surface ID  
Studio – Lewis  
Ph: Khoo Guo Jie  
(p. 228, 289)

Copywritings  
Lodes

Colour separation  
Luce Group

Printing  
Nava Press

Lodes products were made using specific processing techniques and treatments, aimed at creating unique results. Any differences between individual items are therefore designed to ensure that every single product is special and unique.

I prodotto *Lodes* sono stati realizzati con particolari lavorazioni e trattamenti al fine di ottenere risultati unici. Per tale ragione, eventuali differenze da pezzo a pezzo sono volte a garantire specialità ed unicità ad ogni singolo prodotto.



