

hover

barcelona lights

Outdoor book





hoyer  
barcelona lights

Outdoor book

**Appliques**  
*Wall Lamps*

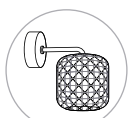

Nans, 32



Nut, 80



Platet, 110

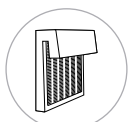

Sisal, 116

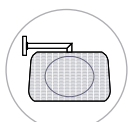

Fora, 150



Garota, 175

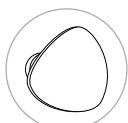

Tria, 204

**Plafones**  
*Ceiling Lamps*



Nans, 30



Nans Sphere, 42



Nut, 88



Soft, 96



Mediterrània, 102

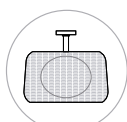

Fora, 161



Garota, 173

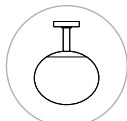

Elipse, 147



Perris, 107

**Suspensió**  
*Pendant Lamps*



Nans, 6



Nans Sphere, 40



Nans S/55, 46



Nans Balis, 52

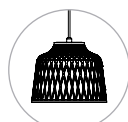

Soft, 94

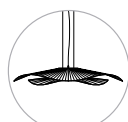

Mediterrània, 98

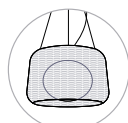

Fora, 158



Garota, 169



Syra, 184

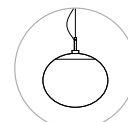

Elipse, 144



Marietta, 210



Maxi, 219

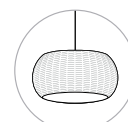

Perris, 104

*Mesa  
Table Lamps*



Nans, 64



Nans Portable, 56



Tanit, 124



Atticus M/39, 141

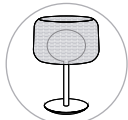

Fora, 152

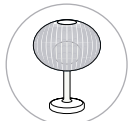

Garota, 166

*Pie  
Floor Lamps*

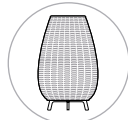

Amphora, 130



Atticus, 141

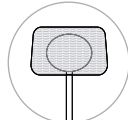

Fora, 154

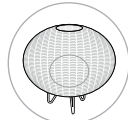

Garota, 167



Maxi, 216

*Recargables  
Battery*



Nans, 64



Nans Portable, 56



Atticus, 141, 143



Tanit, 124



Nit, 74

*Balizas  
Bollards*



Atticus, 138



Cornet, 192



Moai, 200

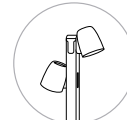

Nut, 90

*Hang*



Nans, 10

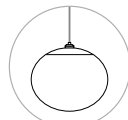

Elipse, 144



Garota, 164

*Catenarias  
Catenary*

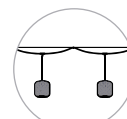

Nans, 12

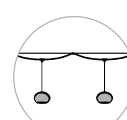

Garota, 171





## Nuestra historia

La ribera del Mediterráneo fue la cuna del Neolítico en Europa, vio nacer y crecer las primeras grandes civilizaciones.

A lo largo de sus costas, Fenicios, Persas, Egipcios, Griegos y finalmente los Romanos, levantaron sus asentamientos. Y fue así, como nos regalaron siglos y siglos de sabiduría, que pusieron a nuestro alcance, transformando nuestras costumbres y nuestros hábitos.

Culturas ancestrales que mezclándose entre nuestras calles, plazas y mercados, dieron lugar a nuestra historia. Contribuyendo con su saber a crear un nuevo arte, conocimiento y filosofía de vida que aún perdura.

## *Our story*

*The Mediterranean shores were the cradle of the Neolithic in Europe where the birth and growth of the first great civilizations took place.*

*Along its coasts, Phoenicians, Persians, Egyptians, Greeks and finally the Romans made their settlements. Thus they passed on centuries of wisdom which was offered to us to shape our customs and the way we live.*

*Ancestral cultures that permeated our streets, squares and markets to create our history. Contributing with their enlightenment to the creation of new art, knowledge and a philosophy of life that to this day remains unaltered.*

# Nans

by Joana Bover | 2021









Cala Nans es una pequeña Cala de Cadaqués, solo accesible por caminos de Ronda o por mar.

Un rincón virgen del Mediterráneo, donde la vegetación y la vigilia de un viejo Faro, hacen de este lugar un espacio natural, donde solo se puede escuchar el sonido del mar y las aves que sobrevuelan la costa.

Con las Nans, hemos querido poner de relieve el trabajo artesanal de sus pantallas, buscar un modo distinto de tejer la trama, combinarla con distintos colores y formatos dando vida a un estilo esencialmente mediterráneo.

*Cala Nans is a small cove in Cadaqués accessible only by footpaths or by sea.*

*An unspoiled corner of the Mediterranean where the vegetation and an old lighthouse's vigil make this place a natural spot where all you can hear are the sound of the sea and of the birds that fly over the coast.*

*With Nans we wanted to highlight the craftsmanship of the lampshades and to look for a different way of weaving by combining different colours and formats to create a true Mediterranean style.*









Nans S/16/H





Nans S/16/H





Nans Catenary S/16/4L





## Cultura Mediterránea

A través de los siglos, el mar ha actuado como elemento cohesionador del paisaje y la cultura de sus pueblos. Las personas que vivimos a lo largo de su costa occidental, compartimos un modo de vida abierto al exterior que nos identifica. La esencia de la cultura mediterránea es la riqueza lingüística, la gastronomía y el conocimiento de los oficios.

## *Mediterranean Culture*

*Over the centuries, the sea has been the binding element in the landscape and culture of its towns.*

*Those of us who live along its western shores share a way of life that is characterized by our openness to the outside world. The essence of the Mediterranean culture are its linguistic richness, its cuisine and its skills in the trades.*

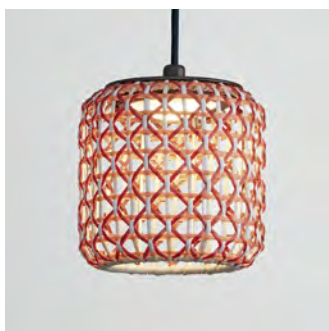

Las Nans nos permiten realizar distintas composiciones de estructuras y pantallas, consiguiendo una amplia gama de usos y aplicaciones.

*Nans lights enable us to create different compositions of structures and shades, achieving a wide range of uses and applications.*









Nans S/16/H







Nans S/21 | S/31.2 | S/31









Nans S/3L | Indoor IP-20









Nans S/3L | Indoor IP-20

















Nans S/31.2









Nans S/21 | S/31.2 | S/31 | S/16





Nans S/31.2





Nans PF/31









Nans A/02





Nans A/02



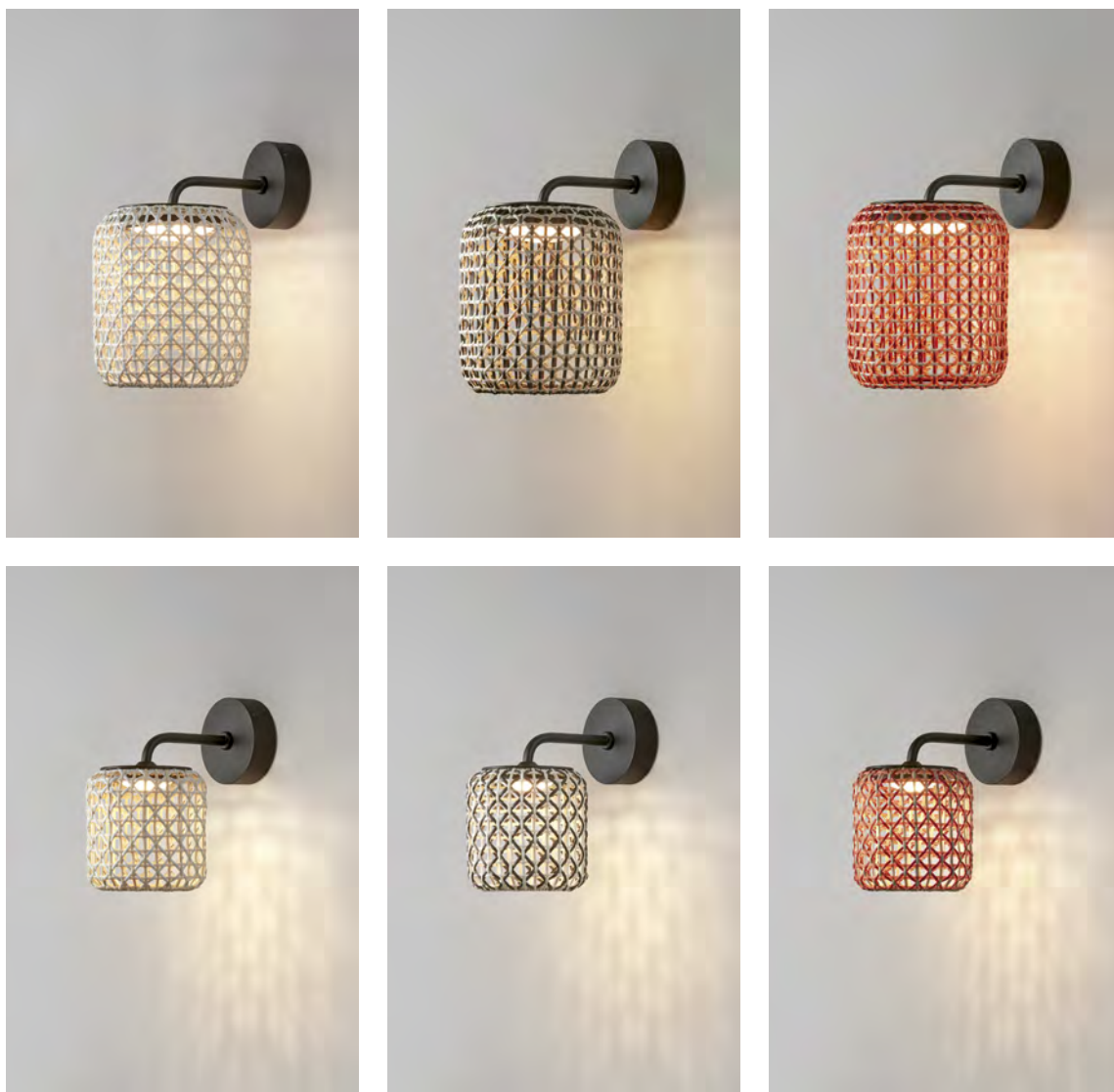

Acabados / Finishing

Sólo para pantallas Nans 31 / Only for Nans 31 shades



Roja / Red



Marrón / Brown

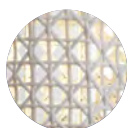

Beige / Beige

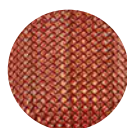

Roja / Red



Marrón / Brown

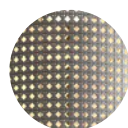

Beige / Beige







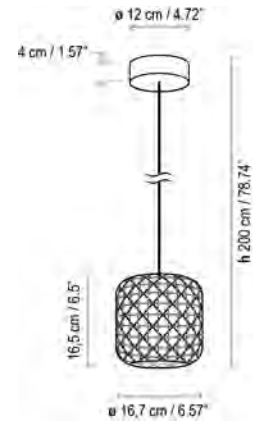
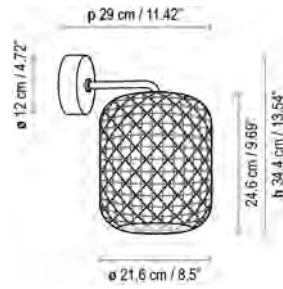
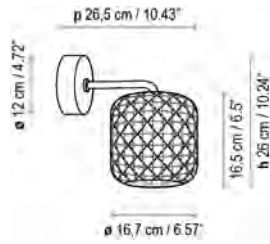

Nans A /01 IP-54

TRIAC | 8 W LED / CRI: 90 / 2700°K  
635 lm fuente de luz / light source

Nans A /02 IP-54

TRIAC | 9,5 W LED / CRI: 90 / 2700°K  
1450 lm fuente de luz / light source

Nans S /16 IP-54

TRIAC | 8 W LED / CRI: 90 / 2700°K  
635 lm fuente de luz / light source

Only for North America

Nans A /01 WET

| 8 W LED / CRI: 90 / 2700°K  
622 lm light source

Nans A /02 WET

| 9,5 W LED / CRI: 90 / 2700°K  
1450 lm light source

Nans S /16 WET

| 8 W LED / CRI: 90 / 2700°K  
622 lm light source

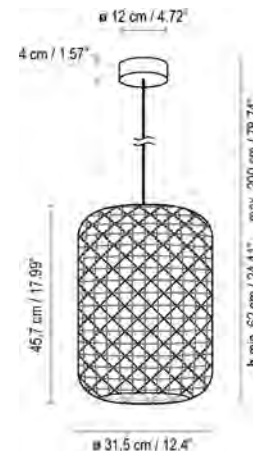
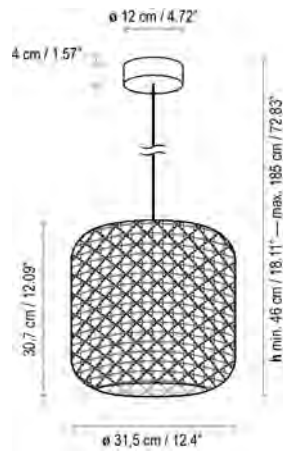
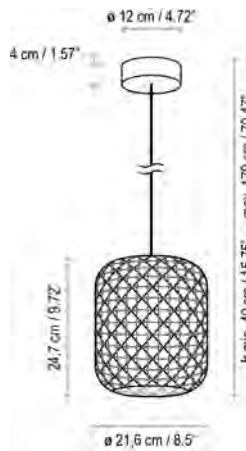

Nans S /21 IP-54

TRIAC | 9,5 W LED / CRI: 90 / 2700°K  
1450 lm fuente de luz / light source

Nans S /31 IP-54

TRIAC | 9,5 W LED / CRI: 90 / 2700°K  
1450 lm fuente de luz / light source

Nans S /31.2 IP-54

TRIAC | 9,5 W LED / CRI: 90 / 2700°K  
1450 lm fuente de luz / light source

Only for North America

Nans S /21 WET

| 9,5 W LED / CRI: 90 / 2700°K  
1450 lm light source

Nans S /31 WET

| 9,5 W LED / CRI: 90 / 2700°K  
1450 lm light source

Nans S /31.2 WET

| 9,5 W LED / CRI: 90 / 2700°K  
1450 lm light source



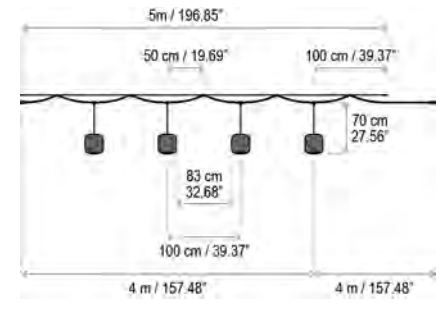
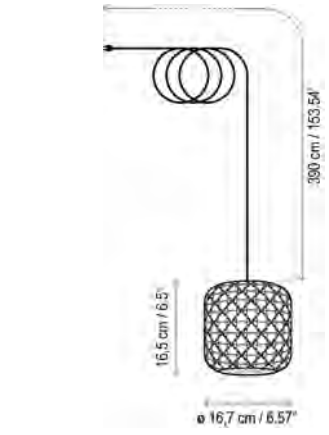
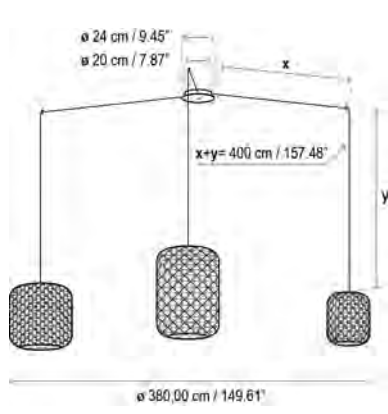

Nans S /3L IP-20  
 TRIAC 3 x 9,5 W LED / CRI: 90 / 2700°K  
 3 x 1450 lm fuente de luz / light source

Nans S /16/H IP-54  
 8 W LED / CRI: 90 / 2700°K  
 635 lm fuente de luz / light source

Nans Catenary S /16/4L IP-54  
 4 x 8 W LED / CRI: 90 / 2700°K  
 4 x 635 lm fuente de luz / light source

Only for North America

Nans S /3L DRY  
 0-10V TRIAC 3 x 9,5 W LED / CRI: 90 / 2700°K  
 3 x 1450 lm light source

Nans S /16/H WET  
 8 W LED / CRI: 90 / 2700°K  
 622 lm light source

Nans Catenary S /16/4L WET  
 4 x 8 W LED / CRI: 90 / 2700°K  
 4 x 622 lm light source

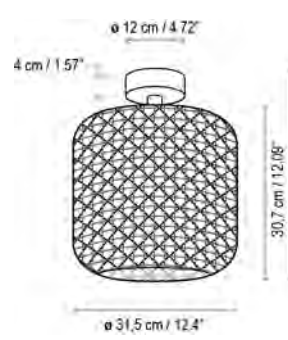
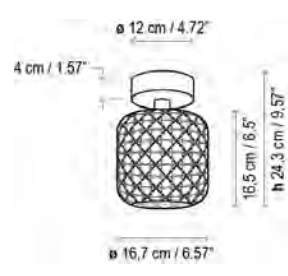

Nans PF /16 IP-54  
 TRIAC 8 W LED / CRI: 90 / 2700°K  
 635 lm fuente de luz light source

Nans PF /21 IP-54  
 TRIAC 9,5 W LED / CRI: 90 / 2700°K  
 1450 lm fuente de luz light source

Nans PF /31 IP-54  
 TRIAC 9,5 W LED / CRI: 90 / 2700°K  
 1450 lm fuente de luz light source

Nans PF /31.2 IP-54  
 TRIAC 9,5 W LED / CRI: 90 / 2700°K  
 1450 lm fuente de luz light source

Only for North America

Nans PF /16 WET  
 TRIAC 8 W LED / CRI: 90 / 2700°K  
 622 lm light source

Nans PF /21 WET  
 0-10V TRIAC 9,5 W LED / CRI: 90 / 2700°K  
 1450 lm light source

Nans PF /31 WET  
 0-10V TRIAC 9,5 W LED / CRI: 90 / 2700°K  
 1450 lm light source

Nans PF /31.2 WET  
 0-10V TRIAC 9,5 W LED / CRI: 90 / 2700°K  
 1450 lm light source



Quizás porque somos del mediterráneo;  
el outdoor es uno de los campos en los que Bover  
es más conocida.

El denominador común de esta colección  
es la combinación de resistencia y sensibilidad.  
Resistencia ya que está diseñada para poder vivir  
cómodamente a la intemperie, y sensibilidad  
expresada en la delicadeza con que tamiza la luz  
y la calidez general de la lámpara. Estas características  
hacen que tanto dentro como fuera de un espacio  
arquitectónico, ayuden a crear una sensación  
de continuidad.





*It is probably because we come from the Mediterranean that the outdoors is one of the areas for which Bover is best known.*

*This collection's common denominator is the combination of resistance and sensitivity. Resistance because it is designed to be able to stay happily outdoors, and its sensitivity shows in the delicacy with which it filters the light and the overall warmth of the lamp. These features help to create a sense of continuity both on the inside and outside of an architectural space.*







COFFEE

Nans Sphere S/60 | S/80



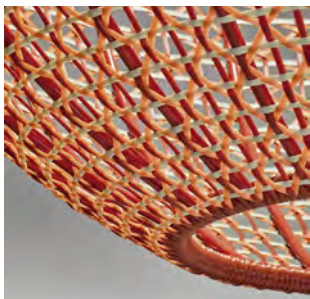

Roja / Red

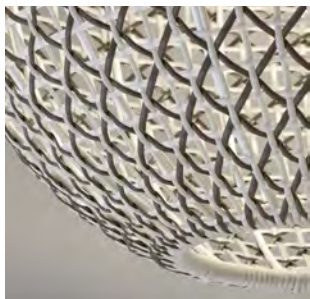

Marrón / Brown

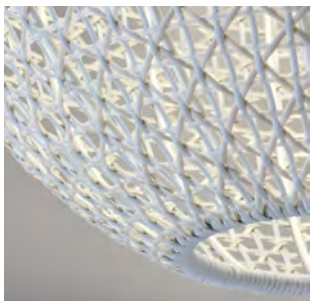

Beige / Beige

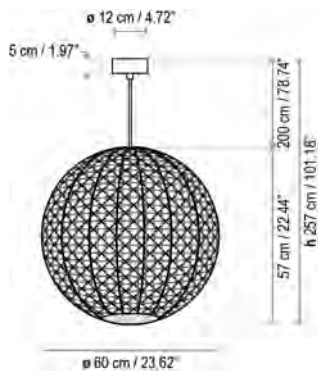

Nans Sphere S/60 IP-54



 14 W LED / CRI: 90 / 2700°K  
 1400 lm fuente de luz / light source

Only for North America

Nans Sphere S/60 WET

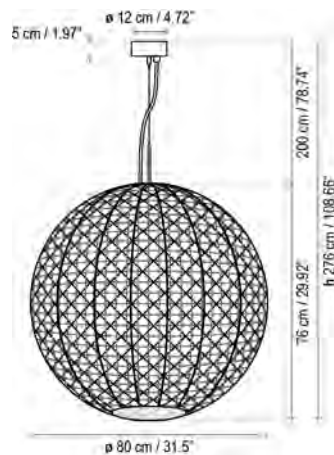

 14 W LED / CRI: 90 / 2700°K  
 1400 lm light source



Nans Sphere S/80 IP-54

 24 W LED / CRI: 90 / 2700°K  
 2400 lm fuente de luz / light source

Nans Sphere S/80 WET



 24 W LED / CRI: 90 / 2700°K  
 2400 lm light source





Nans Sphere PF/60



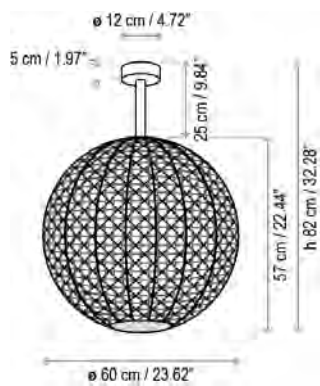

Nans Sphere PF/60 IP-54



 14 W LED / CRI: 90 / 2700°K  
 1400 lm fuente de luz / light source

Only for North America

Nans Sphere PF/60 WET

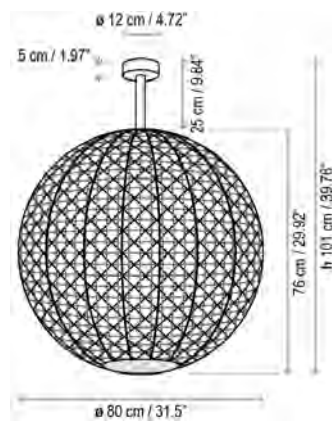

 14 W LED / CRI: 90 / 2700°K  
 1400 lm light source



Nans Sphere PF/80 IP-54

 24 W LED / CRI: 90 / 2700°K  
 2400 lm fuente de luz / light source

Nans Sphere PF/80 WET



 24 W LED / CRI: 90 / 2700°K  
 2400 lm light source

Nans Sphere PF/60





Nans





Nans Sphere S/60 | S/80





Nans S/55













La pantalla de la Nans S/55, está tejida a mano con una trama más elaborada, que combina distintos modos de tejer la fibra en un mismo plano.

Se diferencia del resto de la colección, porque incorpora un difusor de polietileno de forma elíptica, que matiza la luz y evita el deslumbramiento.

*The Nans S/55 shade is hand woven with a more elaborate weave, combining different ways of weaving the fibre in the same layer.*

*It is different from the rest of the collection, because it incorporates an elliptical polyethylene diffuser, which filters the light and prevents glare.*





Nans S/55



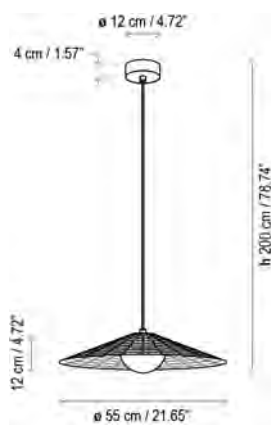

Nans S/55 IP-54

  8 W LED / CRI: 90 / 2700°K  
635 lm fuente de luz / light source

Only for North America

Nans S/55 WET

  8 W LED / CRI: 90 / 2700°K  
635 lm light source

Acabados / Finishing

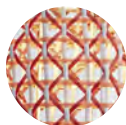

Roja / Red

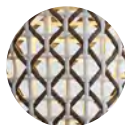

Marrón / Brown

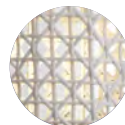

Beige / Beige





Pensada para resolver la iluminación lineal en espacios que requieran una luz suspendida en el ambiente y que, al mismo tiempo, nos permitan flexibilidad o cambios, en función de las necesidades de cada evento. El difusor es de polietileno e incorpora en su interior la placa Led de 24v.

*Designed for linear lighting solutions in spaces that require a light suspended in the air while allowing for flexibility or changes, depending on the needs of each event. The diffuser is made of polyethylene and incorporates inside the 24v LED plate.*





Nans Balis S/140







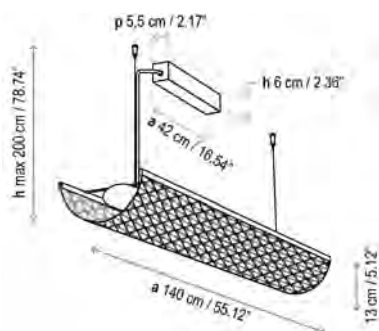
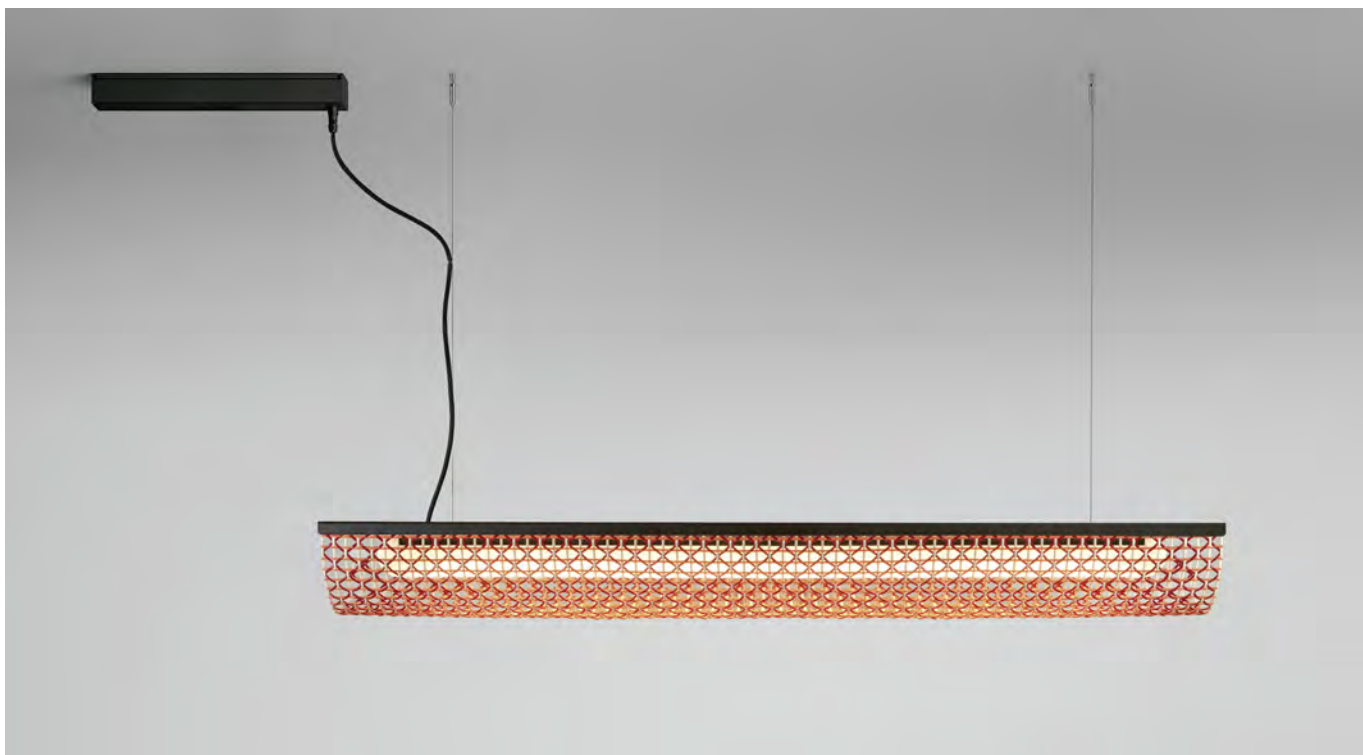



Nans Balis S/140 IP-54

  24 V / 44 W LED / CRI: 90 / 2400°K  
4400 lm fuente de luz / *light source*

Only for North America

Nans Balis S/140 WET

  24 V / 44 W LED / CRI: 90 / 2400°K  
4400 lm light source

Acabados / Finishing

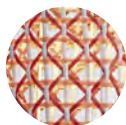

Roja / Red

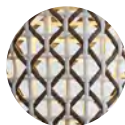

Marrón / Brown

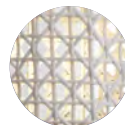

Beige / Beige



# Nans Portable

by Joana Bover | 2021

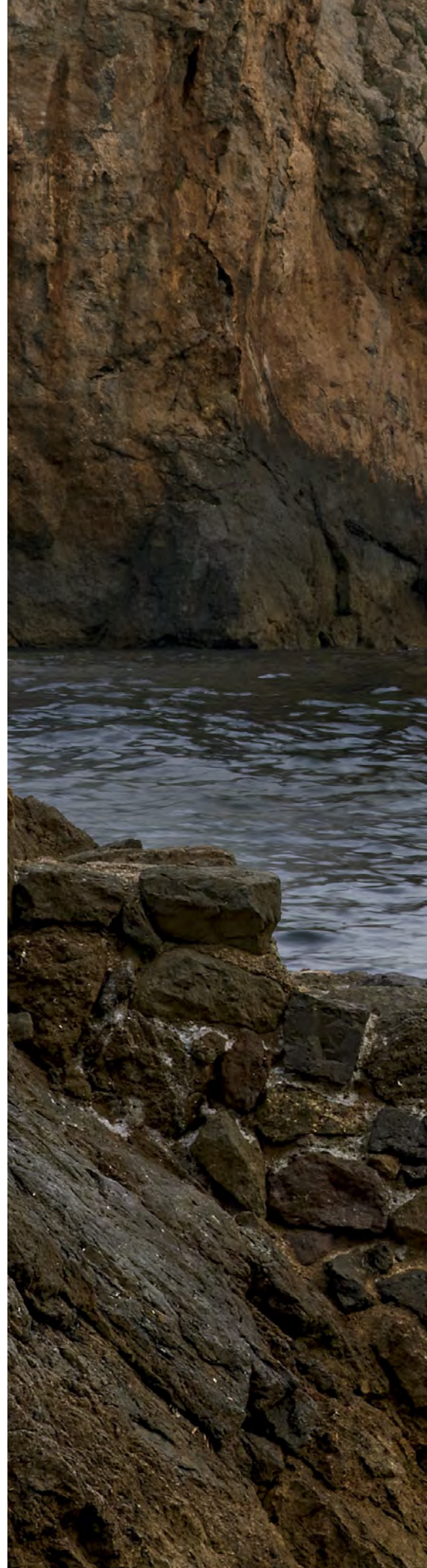









Nans Portable M/41/R | M/49/R | Battery









Nans Portable M/49/R | Battery



Mare Nostrum  
Mediterráneo  
Nuestro mar

A veces me pregunto, qué hace que este mar  
sea tan especial para todos los que vivimos en su ribera.  
¿Ocurre lo mismo en todos los mares?

Para los que vivimos a orillas del Mediterráneo,  
el mar, es nuestra visión infinita de las cosas y de la vida.  
Es nuestro universo, el punto desde el que partimos  
y al que siempre queremos regresar.

*Mare Nostrum  
Mediterranean  
Our sea*

*Sometimes I wonder what makes this sea  
so special to all of us who live on its shores.  
Does the same hold true for all seas?*

*For those of us who live on the shores of the Mediterranean,  
the sea is our infinite vision of things and life.  
It is our universe, the point from where we start  
and where we always seek to return.*





Nans Portable M/41 | M/49





Nans Portable M/49/R | Battery





Nans M/21/R | Indoor | Battery





Nans M/21/R | Indoor | Battery





Nans M/21/R IP-20

3 W LED / CRI: 90 / 2700°K  
460 lm fuente de luz / light source

Only for North America

Nans M/21/R DRY

3 W LED / CRI: 90 / 2700°K  
460 lm light source

Nans M/21/R | Indoor | Battery



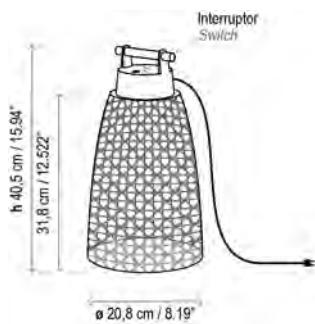

Nans Portable M/41 IP-54

6,3 W LED / CRI: 90 / 2700°K  
950 lm fuente de luz / light source

Only for North America

Nans Portable M/41 WET

6,3 W LED / CRI: 90 / 2700°K  
950 lm light source



Nans Portable M/41/R IP-54

3 W LED / CRI: 90 / 2700°K  
460 lm fuente de luz / light source

Nans Portable M/41/R WET

3 W LED / CRI: 90 / 2700°K  
460 lm light source

Nans Portable M/41/R | Battery



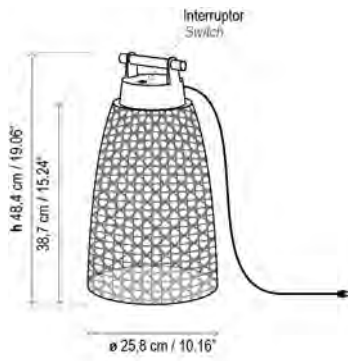

Nans Portable M/49 IP-54

⊙ 6,3 W LED / CRI: 90 / 2700°K  
950 lm fuente de luz / *light source*

Only for North America

Nans Portable M/49 WET

⊙ 6,3 W LED / CRI: 90 / 2700°K  
950 lm light source



Nans Portable M/49/R IP-54

⊙ 3 W LED / CRI: 90 / 2700°K  
460 lm fuente de luz / *light source*

Nans Portable M/49/R WET

⊙ 3 W LED / CRI: 90 / 2700°K  
460 lm light source







Acabados / Finishing

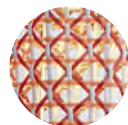

Roja / Red

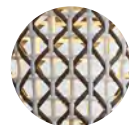

Marrón / Brown

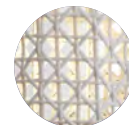

Beige / Beige









Nans Portable M/49/R | Battery





Hotel Gran Meliá de Mar – Illetes / Mallorca







# Nit

by Gonzalo Milà | 2023

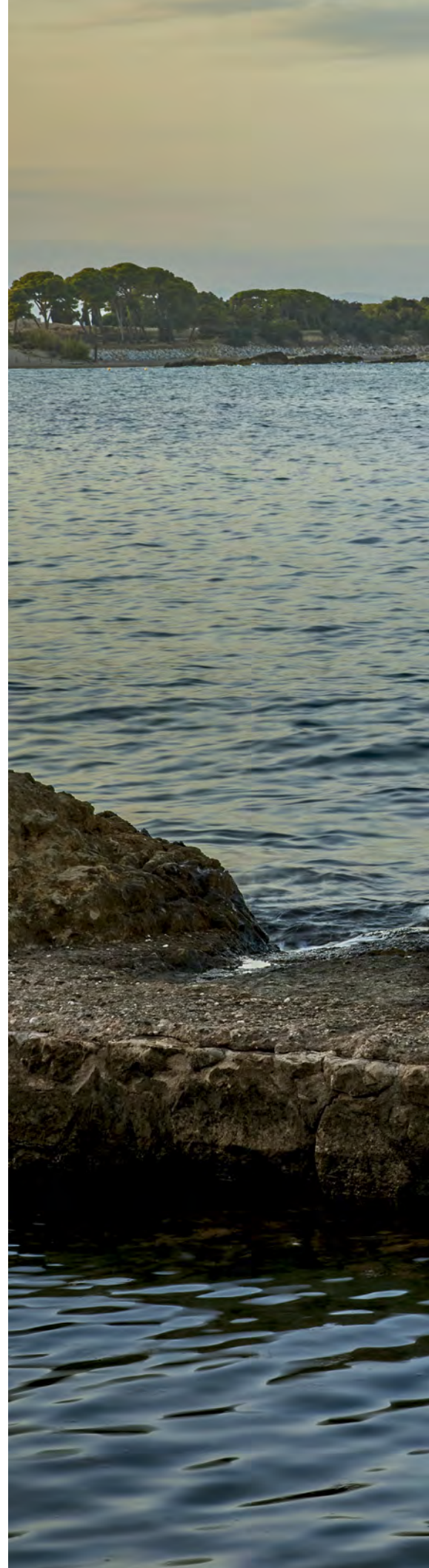









Nit /80/R



Una superficie circular que flota sobre una falda iluminada, integrando la luz ordenadamente sin ocupar superficie útil y alumbrando lo mínimo para desenvolverse a su alrededor.

La lámpara es de batería y emite luz superior e inferior.  
La luz superior emerge de forma discreta, asomándose por encima de la superficie, con el objetivo de bañar suavemente el sobre de la mesa y facilitar la visión de los objetos en la oscuridad.

El mismo cilindro de luz, se adentra en la parte interior de la estructura metálica, iluminando de forma indirecta, la pantalla tejida a mano con cordón marino o médula sintética.

*A circular surface that floats on an illuminated skirt, integrating the light in an orderly manner without occupying a usable area and illuminating the minimum to open out around it.*

*The lamp is battery-powered and emits light above and below. The upper light emerges discreetly, peeking above the surface, with the aim of gently bathing the table top and revealing objects in the dark.*

*The light cylinder penetrates into the inside of the metal structure, indirectly illuminating the screen woven by hand with nautical cord or synthetic rattan.*









Nit /60/R

IP-44

⊙ 3 W LED / CRI: 90 / 2700°K  
460 lm fuente de luz / light source

Only for North America

Nit /60/R

WET

⊙ 3 W LED / CRI: 90 / 2700°K  
460 lm light source

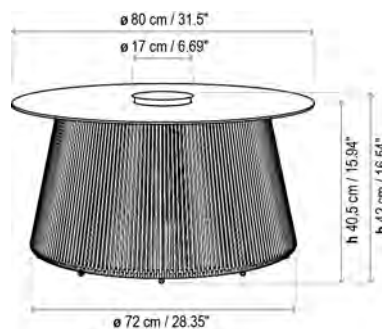

Nit /80/R

IP-44

⊙ 3 W LED / CRI: 90 / 2700°K  
460 lm fuente de luz / light source

Nit /80/R

WET

⊙ 3 W LED / CRI: 90 / 2700°K  
460 lm light source

Acabados / Finishing



Sobre Teja / Cuerda Naranja  
Terracota Top / Orange Rope



Sobre Piedra / Cuerda Rattan Marrón  
Stone Top / Brown Rattan Rope

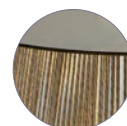

Sobre Marfil / Cuerda Rattan Beige  
Ivory Top / Beige Rattan Rope



# Nut

by Estudi Manel Molina | 2021

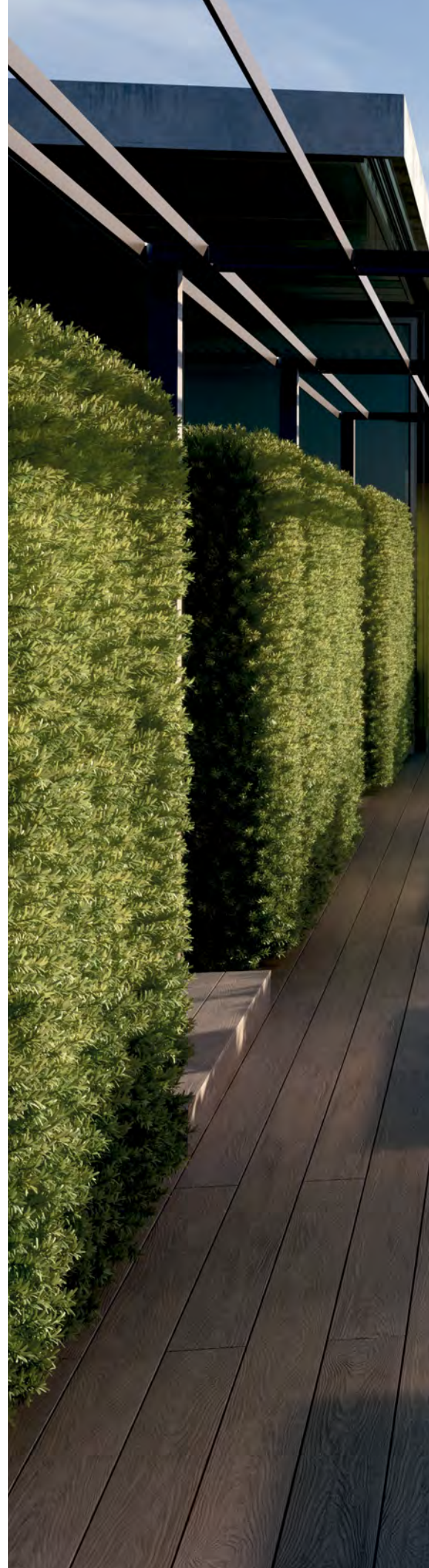







Las Nut se caracterizan por su cuerpo ergonómico y contundente. Son un producto altamente versátil, su manejo es fácil e intuitivo y pueden orientarse 180°. Pueden instalarse en ambientes Indoor y Outdoor.

*The Nut collection is characterized by their ergonomic and solid build. They are a highly versatile product. Their handling is easy and intuitive, and they can be positioned 180°. They can be used both for Indoor as well as Outdoor environments.*







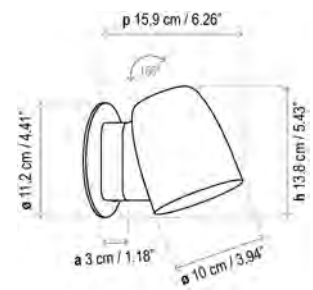
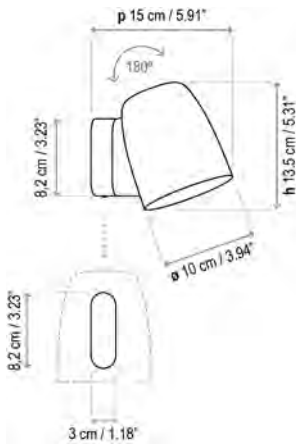

Only for North America

Nut A/01 IP-54

  6,3 W LED / CRI: 90 / 2700°K  
950 lm fuente de luz / light source

Nut A/01 WET

   6,3 W LED / CRI: 90 / 2700°K  
950 lm light source

Image does not show north American backplate



Negro  
Black



Marrón Grafito  
Graphite Brown



Teja  
Terracotta



Blanco  
White



Gris claro  
Light grey





Nut A/01





Nut A/01









Nut PF/10 IP-54



6,3 W LED / CRI: 90 / 2700°K  
950 lm fuente de luz / light source

Only for North America

Nut PF/10 WET



6,3 W LED / CRI: 90 / 2700°K  
950 lm light source

Image does not show north American backplate

Nut PF/10









Con las Nut baliza hemos querido ampliar la familia y llevarnos las balizas al jardín, para mezclarlas con el verde de las plantas y los arbustos.

Las balizas emiten un halo de luz inferior matizada y directa con un ángulo de 55°. No son orientables.

*With Nut bollards we've wanted to expand the family and take the bollards out into the garden to blend them with the green of the plants and bushes.*

*The bollards emit a halo of nuanced, direct lower light at an angle of 55°. They are non-directional.*









Nut B/60 | B/90/2L



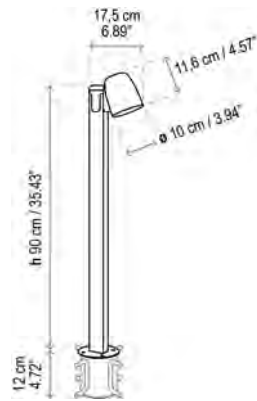
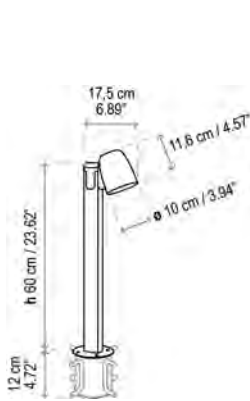

Nut B/60 IP-54

  6,3 W LED / CRI: 90 / 2700°K  
950 lm fuente de luz / light source

Nut B/90 IP-54

  6,3 W LED / CRI: 90 / 2700°K  
950 lm fuente de luz / light source

Nut B/90/2L IP-54

  2 x 6,3 W LED / CRI: 90 / 2700°K  
2 x 950 lm fuente de luz / light source

Only for North America

Nut B/60 WET

  6,3 W LED / CRI: 90 / 2700°K  
950 lm light source

Nut B/90 WET

  6,3 W LED / CRI: 90 / 2700°K  
950 lm light source

Nut B/90/2L WET

  6,3 W LED / CRI: 90 / 2700°K  
950 lm light source



# Soft

by Danos Salgados | 2022

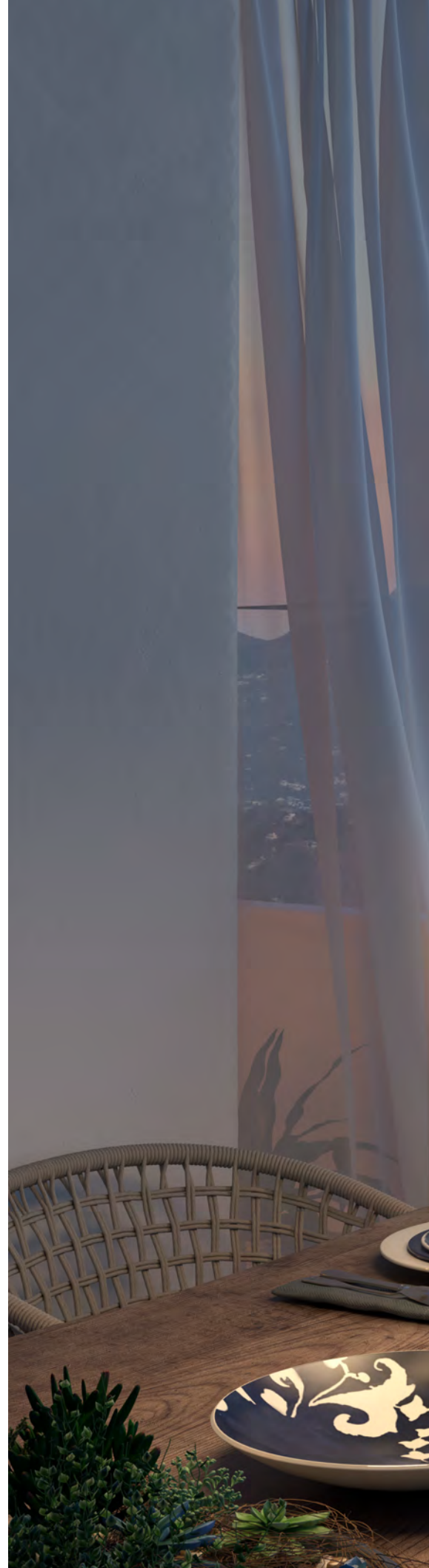





Soft S/30





Soft PF/30



*Soft light fixtures are light and colourist, with a fresh appearance that projects a clear, direct lower light shaded by a polycarbonate diffuser. Made in silicone, the print on their shade is a reminder of classic wine glasses made of Bohemian glass. Soft lights adapt to all preferences and both indoor and outdoor spaces. They can easily be disassembled for cleaning.*

Las Soft son ligeras y coloristas, con un aspecto fresh que proyectan una luz inferior clara y directa, matizada por un difusor de policarbonato. Realizadas en silicona, el grabado de su pantalla nos recuerda al de las clásicas copas de cristal de Bohemia. Las Soft son lámparas adaptables a todos los gustos y espacios Indoor y Outdoor. Son fácilmente desmontables para su lavado.

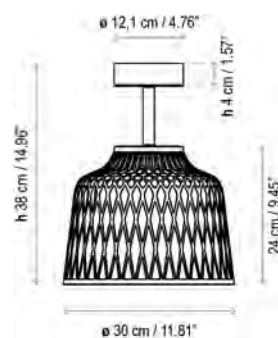
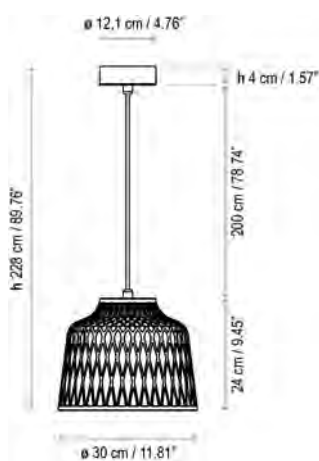

Soft S/30 IP-44

1 x MAX 15 W LED E-27 A60

Soft PF/30 IP-44

1 x MAX 15 W LED E-27 A60

Only for North America

Soft S/30 WET

1 x MAX 15 W E26 LED A19

Soft PF/30 WET

1 x MAX 15 W E26 LED A19

Acabados / Finishing



Light gray  
Gris claro



Ochre  
Ocre



Olive gray  
Gris oliva



# Mediterrània

by Alex Fernández Camps | 2019











Naturaleza, tradición, diseño y tecnología  
son la base de nuestros productos

*Nature, tradition, design and technology are  
the foundation of our products*





Mediterrània S/105







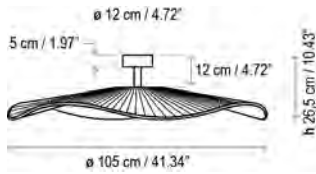

Mediterrània PF/105 IP-66



 17,1 W LED / CRI: 90 / 2700°K  
 2064 lm fuente de luz / light source

Only for North America

Mediterrània PF/105 WET







 17,1 W LED / CRI: 90 / 2700°K  
 2064 lm light source

Mediterrània S/105 IP-66



 17,1 W LED / CRI: 90 / 2700°K  
 2064 lm fuente de luz / light source

Mediterrània S/105 WET



 17,1 W LED / CRI: 90 / 2700°K  
 2064 lm light source

Acabados / Finishing



Marrón / Fibra Sintética Marrón  
 Brown / Brown Sybthetic Fiber

Mediterrània PF/105



# Perris

by Joana Bover | 2023









La lámpara Perris es el clásico ejemplo de producto atemporal, que se adapta sin estridencias y confort a cualquier ámbito. Emite una luz tamizada a través de su pantalla de médula tejida a mano.

Su característica principal son sus prestaciones IN-OUT que nos permiten instalarla en entornos de interior o en nuestros patios, terrazas o porches.

*The Perris lamp is the classic example of a timeless product, which undramatically and comfortably adapts to any environment. It emits a subdued light through its hand-woven rattan shade. Its main benefit is its IN-OUT features with which it can be installed indoors or on patios, terraces or porches.*









Perris S/74



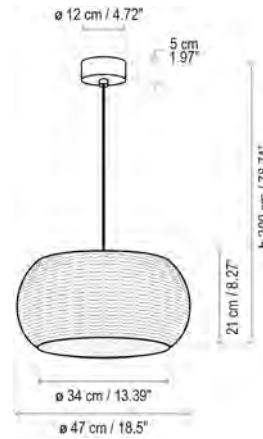

Perris PF/47 IP-54

  17,1 W LED / CRI: 90 / 2700°K  
2064 lm fuente de luz / light source

Perris S/47 IP-54

  17,1 W LED / CRI: 90 / 2700°K  
2064 lm fuente de luz / light source

Only for North America

Perris PF/47 WET

  17,1 W LED / CRI: 90 / 2700°K  
2064 lm light source

Perris S/47 WET

  17,1 W LED / CRI: 90 / 2700°K  
2064 lm light source

Acabados / Finishing



Marrón Grafito  
Graphite Brown



Beige Claro  
Light Beige



Marrón Rattan  
Rattan Brown



# Platet

by Christophe Mathieu | 2020







Platet A/02 / Indoor





Platet A/01 / Outdoor





Formas simples, que nos resultan familiares y nos hacen viajar a través del tiempo. Adaptado a la fuente de luz LED, hay algo de romántico en la Platet. La paleta de color incorpora tonos sobrios y cálidos, siempre con la parte interior de la pantalla de color blanco que nos proporciona una buena calidad de luz.

*Simple shapes that have a familiar feeling and make us travel through time. There is something romantic about the LED adapted Platet. Its colour palette includes sober and warm tones and the inner side of the lampshade is always white for good light quality.*



Marrón / Brown



Verde / Green



Negro / Black





Platet A/01 Outdoor / Custom length



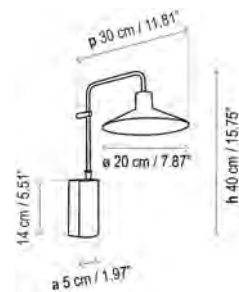

Platet A/01 IP66

4,2 W LED / CRI: 90 / 2700°K  
504 lm fuente de luz / light source



Only for North America

Platet A/01 WET

4,2 W LED / CRI: 90 / 2700°K  
504 lm light source



# Sisal

by Joana Bover | 2019











Sisal A/01





Sisal A/01



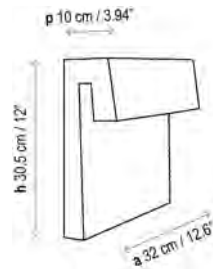
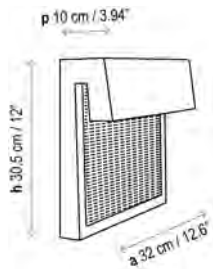

Sisal A/01 IP66



9,1 W LED / CRI: 90 / 2700°K  
990 lm fuente de luz / light source

Only for North America

Sisal A/01 WET



9,1 W LED / CRI: 90 / 2700°K  
990 lm light source

Acabados / Finishing



Frontal Metal Marrón  
Brown Metal Frontal



Frontal Fibra Marrón  
Brown Fiber Frontal

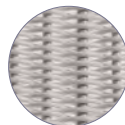

Frontal Fibra Beige Claro  
Light Beige Fiber Frontal







Sisal A/01





Sisal A/01







# Tanit

by Gonzalo Milà | 2019

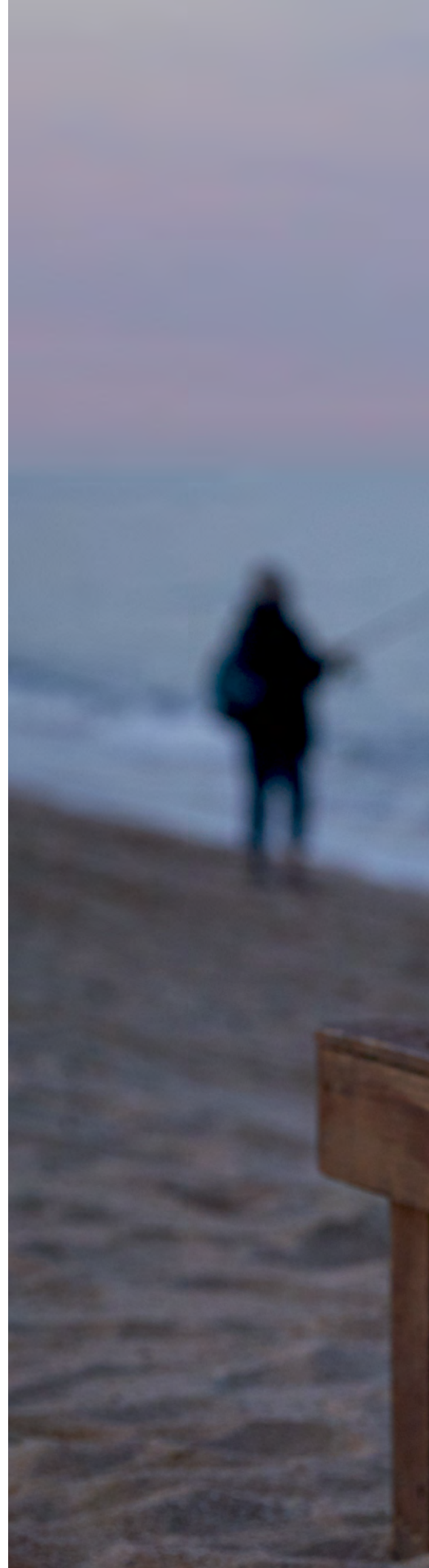





Tanit M/29/R | Indoor | Battery





Tanit M/29/R IP20

1,5 W LED / CRI: 80 / 2700°K  
54 lm fuente de luz / light source

Only for North America

Tanit M/29/R DRY

1,5 W LED / CRI: 80 / 2700°K  
54 lm light source



Tanit M/29/R | Indoor | Battery



Tanit es una lámpara de sobremesa portátil y recargable, de luz suave y tamizada por una pantalla tejida de forma artesanal con hilo de algodón.

*Tanit is a portable and rechargeable table lamp that gives out a soft light filtered through a handwoven cotton thread lampshade.*







Tanit M/29/R | Indoor | Battery







# Amphora

by Alex Fernández Camps / Gonzalo Milà | 2013











Sus grandes volúmenes y formas rinden un sutil y discreto homenaje a las ánforas de terracota que antiguamente se utilizaban para almacenar alimentos.

*The size and shape of this collection pay a subtle and discreet homage to the terracotta amphoras used once upon a time to store food.*





Amphora 03









Amphora 02



Opciones LED consultar dibujo  
técnico en la ficha técnica

LED options consult technical  
drawing in the cutsheet

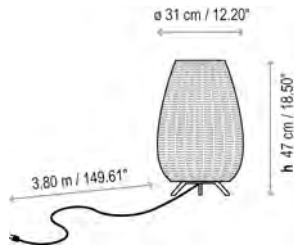

Amphora IP-66

8 W LED / CRI: 90 / 2700°K  
635 lm fuente de luz / *light source*

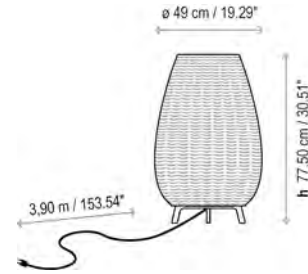

Amphora 01 IP-66

2 x MAX 15 W LED E-27 A60  
17,1 W LED / CRI: 90 / 2700°K  
2064 lm fuente de luz / *light source*  
TRIAC | 17,1 W LED / CRI: 90 / 2700°K  
2064 lm fuente de luz / *light source*

Only for North America

Amphora WET

8 W LED / CRI: 90 / 2700°K  
622 lm light source

Amphora 01 WET

2 x 10 W E26 LED A19  
0-10V | TRIAC | 17,1 W LED / CRI: 90 / 2700°K  
2064 lm light source



Opciones LED consultar dibujo técnico en la ficha técnica

LED options consult technical drawing in the cutsheet

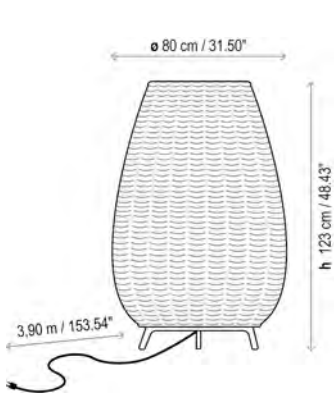

Opciones LED consultar dibujo técnico en la ficha técnica

LED options consult technical drawing in the cutsheet

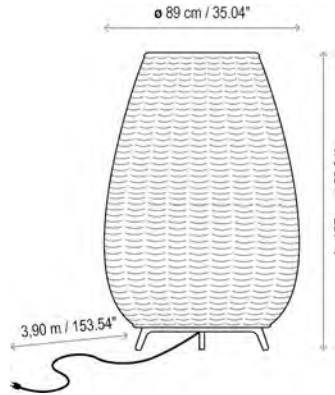

Amphora 02 IP-66

- 2 x MAX 15 W LED E-27 A60
- 24,7 W LED / CRI: 90 / 2700°K  
3000 lm fuente de luz / light source
- 24,7 W LED / CRI: 90 / 2700°K  
3000 lm fuente de luz / light source

Amphora 03 IP-66

- 2 x MAX 15 W LED E-27 A60
- 24,7 W LED / CRI: 90 / 2700°K  
3000 lm fuente de luz / light source
- 24,7 W LED / CRI: 90 / 2700°K  
3000 lm fuente de luz / light source

Only for North America

Amphora 02 WET

- 2 x 10 W E26 LED A19
- 24,7 W LED / CRI: 90 / 2700°K  
3000 lm light source

Amphora 03 WET

- 2 x 10 W E26 LED A19
- 24,7 W LED / CRI: 90 / 2700°K  
3000 lm light source

Acabados / Finishing



Marrón Grafito  
Graphite Brown



Beige Claro  
Light Beige



Marrón Rattan  
Rattan Brown



# Atticus

by Joana Bover | 2017

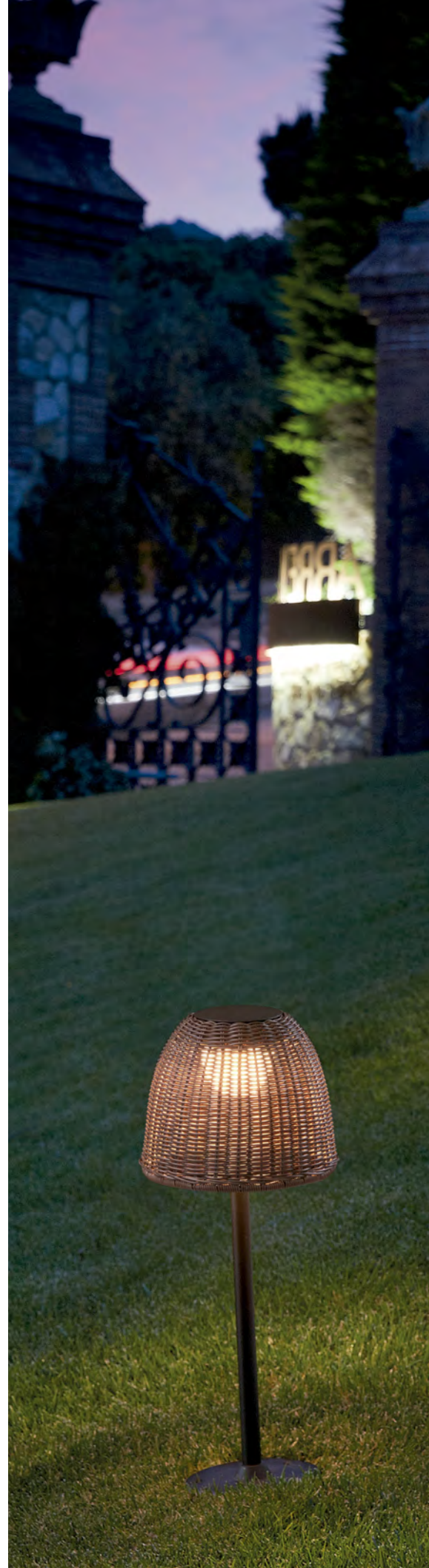









Atticus B/40 | B/50





Atticus M/39 | P/114/R | Battery



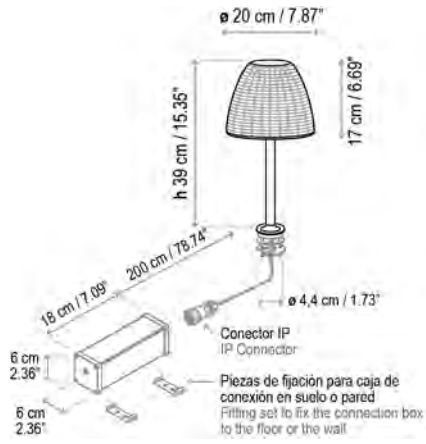

Atticus M/39 IP-54

TRIAAC 8,4 W LED / CRI: 90 / 2700°K  
1200 lm fuente de luz / light source

Only for North America

Atticus M/39 WET

TRIAAC 8,4 W LED / CRI: 90 / 2700°K  
1122 lm light source



Atticus B/40 - B/50 IP-54

TRIAAC 8,4 W LED / CRI: 90 / 2700°K  
1122 lm fuente de luz / light source

Only for North America

Atticus B/56 - B/66 WET

TRIAAC 8,4 W LED / CRI: 90 / 2700°K  
1122 lm light source



Atticus P/114 IP-54

8,4 W LED / CRI: 90 / 2700°K  
1122 lm fuente de luz / light source

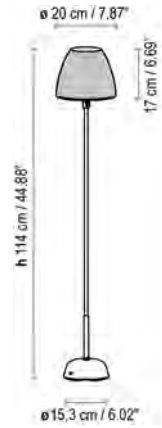

Atticus P/114/R IP-54

3 W LED / CRI: 90 / 2700°K  
460 lm fuente de luz / light source

Atticus P/114/R WET

3 W LED / CRI: 90 / 2700°K  
460 lm light source

Acabados / Finishing



Blanco Roto  
Natural White



Marrón Grafito  
Graphite Brown



Beige Claro  
Light Beige



Marrón Rattan  
Rattan Brown





Atticus P/114/R | Battery



# Elipse

by Alex Fernández Camps / Gonzalo Milà | 2013







Eclipse S/30/H | S/50/H





Eclipse PF/30



Elipse outdoor es una solución sencilla,  
libre y flexible en su aplicación.  
Puede actuar de sobremesa colgada  
de una rama durante una cena, iluminar  
un rincón de un jardín junto a una hamaca,  
o crear una atmósfera mágica  
con un conjunto de Elipses suspendidas  
en la noche. La belleza de la sencillez.

*Elipse outdoor is a simple,  
unrestrained and versatile product.  
It can be hung from a branch over  
a table for a dinner, to light a garden  
corner by a hammock or to create  
a magical atmosphere with a set  
of ellipses hanging in the night.  
The beauty of simplicity.*



Opciones LED consultar dibujo técnico en la ficha técnica

LED options consult technical drawing in the cutsheet

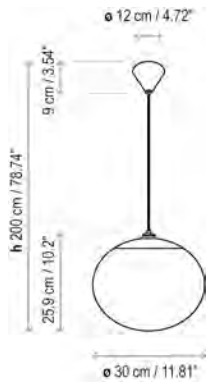

Elipse S/30 IP-66

2 x MAX 15 W LED E-27 A60

17,1 W LED / CRI: 90 / 2700°K  
2064 lm fuente de luz / light source

Opciones LED consultar dibujo técnico en la ficha técnica

LED options consult technical drawing in the cutsheet

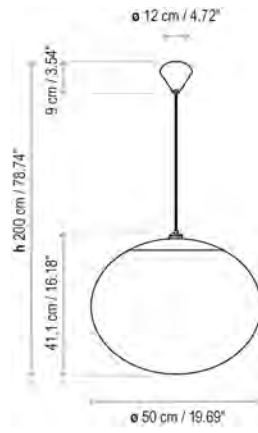

Elipse S/50 IP-66

2 x MAX 15 W LED E-27 A60

24,7 W LED / CRI: 90 / 2700°K  
3000 lm fuente de luz / light source

Opciones LED consultar dibujo técnico en la ficha técnica

LED options consult technical drawing in the cutsheet

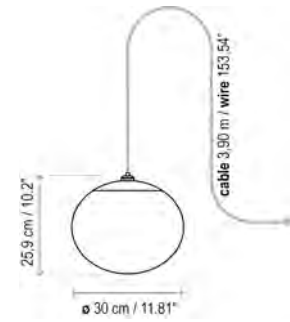

Elipse S/30/H IP-66

2 x MAX 15 W LED E-27 A60

17,1 W LED / CRI: 90 / 2700°K  
2064 lm fuente de luz / light source

Only for North America

Elipse S/30 WET

2 x 10 W E26 LED A19

17,1 W LED / CRI: 90 / 2700°K  
2064 lm light source

Elipse S/50 WET

2 x 10 W E26 LED A19

24,7 W LED / CRI: 90 / 2700°K  
3000 lm light source

Elipse S/30/H WET

2 x 10 W E26 LED A19



Opciones LED consultar dibujo técnico en la ficha técnica

LED options consult technical drawing in the cutsheet

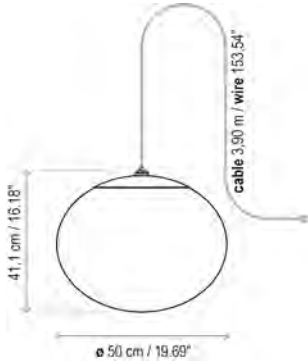

Opciones LED consultar dibujo técnico en la ficha técnica

LED options consult technical drawing in the cutsheet

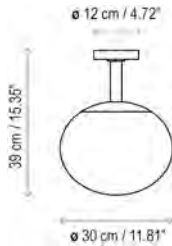

Opciones LED consultar dibujo técnico en la ficha técnica

LED options consult technical drawing in the cutsheet

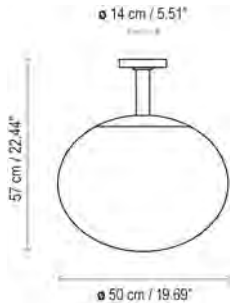

Elipse S/50/H IP-66

2 x MAX 15 W LED E-27 A60

24,7 W LED / CRI: 90 / 2700°K  
3000 lm fuente de luz / light source

Elipse PF/30 IP-66

2 x MAX 15 W LED E-27 A60

17,1 W LED / CRI: 90 / 2700°K  
2064 lm fuente de luz / light source

Elipse PF/50 IP-66

2 x MAX 15 W LED E-27 A60

24,7 W LED / CRI: 90 / 2700°K  
3000 lm fuente de luz / light source

Only for North America

Elipse S/50/H WET

2 x 10 W E26 LED A19

Elipse PF/30 WET

2 x 10 W E26 LED A19

17,1 W LED / CRI: 90 / 2700°K  
2064 lm light source

Elipse PF/50 WET

2 x 10 W E26 LED A19

24,7 W LED / CRI: 90 / 2700°K  
3000 lm light source

Acabados / Finishing



Blanco Roto  
Natural White



Blanco  
White



# Fora

by Alex Fernández Camps / Gonzalo Milà | 2013

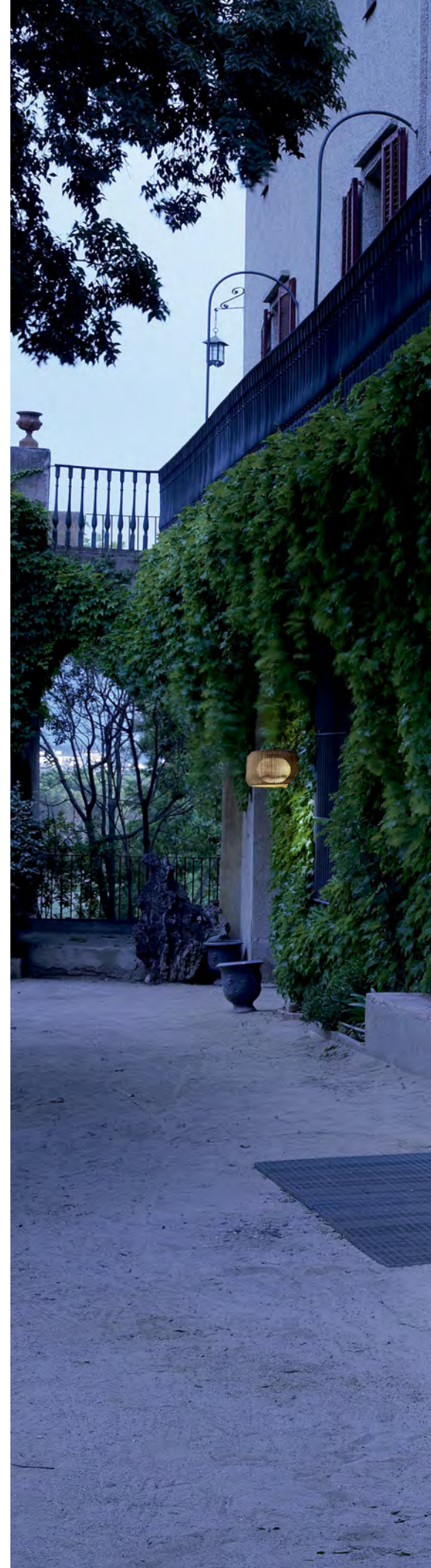









Fora M









Fora P





Fora P





Hotel Gran Meliá Mar  
Illetes / Mallorca























Opciones LED consultar dibujo técnico en la ficha técnica

LED options consult technical drawing in the cutsheet

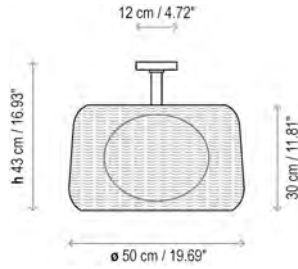
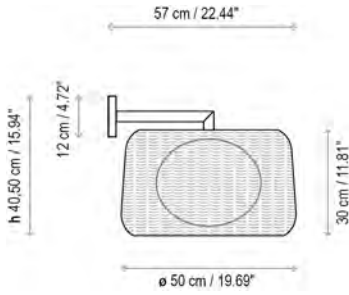

Opciones LED consultar dibujo técnico en la ficha técnica

LED options consult technical drawing in the cutsheet

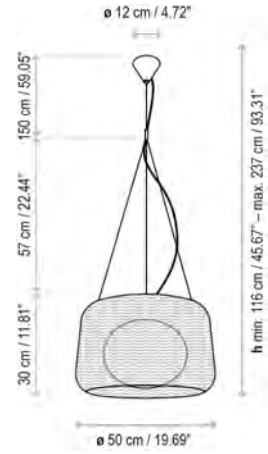

Fora A IP-66

2 x MAX 15 W LED E-27 A60

17,1 W LED / CRI: 90 / 2700°K  
2064 lm fuente de luz / light source

Fora PF IP-66

2 x MAX 15 W LED E-27 A60

17,1 W LED / CRI: 90 / 2700°K  
2064 lm fuente de luz / light source

Fora S IP-66

2 x MAX 15 W LED E-27 A60

17,1 W LED / CRI: 90 / 2700°K  
2064 lm fuente de luz / light source

Only for North America

Fora A WET

2 x 10 W E26 LED A19

17,1 W LED / CRI: 90 / 2700°K  
2064 lm light source

Fora PF WET

2 x 10 W E26 LED A19

17,1 W LED / CRI: 90 / 2700°K  
2064 lm light source

Fora S WET

2 x 10 W E26 LED A19

17,1 W LED / CRI: 90 / 2700°K  
2064 lm light source



Opciones LED consultar dibujo técnico en la ficha técnica

LED options consult technical drawing in the cutsheet

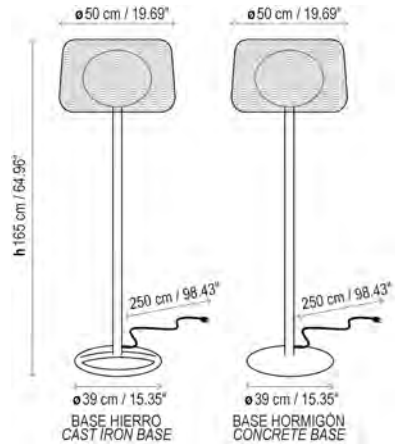
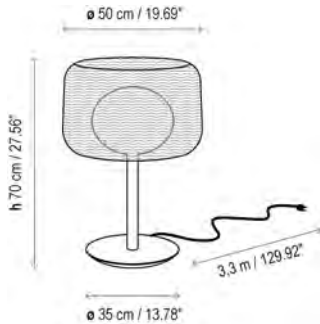
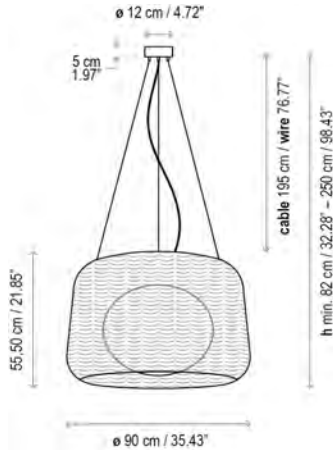

Fora 90 IP-66

2 x MAX 15 W LED E-27 A60

24,7 W LED / CRI: 90 / 2700°K  
3000 lm fuente de luz / light source

Fora M IP-66

2 x MAX 15 W LED E-27 A60

17,1 W LED / CRI: 90 / 2700°K  
2064 lm fuente de luz / light source

Fora P IP-66

2 x MAX 15 W LED E-27 A60

17,1 W LED / CRI: 90 / 2700°K  
2064 lm fuente de luz / light source

Only for North America

Fora 90 WET

2 x 10 W E26 LED A19

24,7 W LED / CRI: 90 / 2700°K  
3000 lm light source

Fora M WET

2 x 10 W E26 LED A19

Fora P WET

2 x 10 W E26 LED A19

Acabados / Finishing



Blanco Roto  
Natural White



Marrón Grafito  
Graphite Brown



Beige Claro  
Light Beige



Marrón Rattan  
Rattan Brown



# Garota

by Alex Fernández Camps / Gonzalo Milà | 2013











Garota M/36





Garota P/01













Garota, inspirada en el caparazón de un erizo de mar, nos ofrece una luz cálida y tamizada, envuelta en formas orgánicas, redondeadas y sutiles, pensada para acompañarnos en zonas de interior y exterior indistintamente.

*Garota, inspired by the shell of a sea urchin, offers a warm and diffused light, wrapped in organic, rounded and subtle shapes, designed to be with us either indoors or outdoors.*





Garota Catenary S/27/4L





Diseño atemporal,  
identidad mediterránea.  
Una mirada distinta,  
sobre los objetos cotidianos  
que nos rodean.

*Timeless design,  
Mediterranean identity.  
A different look  
at the everyday objects  
that surround us.*









Garota Hang





Garota A/01





Glamp 2016, Zion Natural Park / United States  
Photographed by Charlie Simmons





















Garota A/01 IP-66

8,4 W LED / CRI: 90 / 2700°K  
1122 lm fuente de luz / light source

Garota PF/01 IP-66

8,4 W LED / CRI: 90 / 2700°K  
1122 lm fuente de luz / light source

Garota PF/02 IP-66

2 x MAX 15 W LED E-27 A60  
 17,1 W LED / CRI: 90 / 2700°K  
2064 lm fuente de luz / light source

Only for North America

Garota A/01 WET

8,4 W LED / CRI: 90 / 2700°K  
1122 lm light source

Garota PF/01 WET

8,4 W LED / CRI: 90 / 2700°K  
1122 lm light source

Garota PF/02 WET

2 x 10 W E26 LED A19  
 17,1 W LED / CRI: 90 / 2700°K  
2064 lm light source

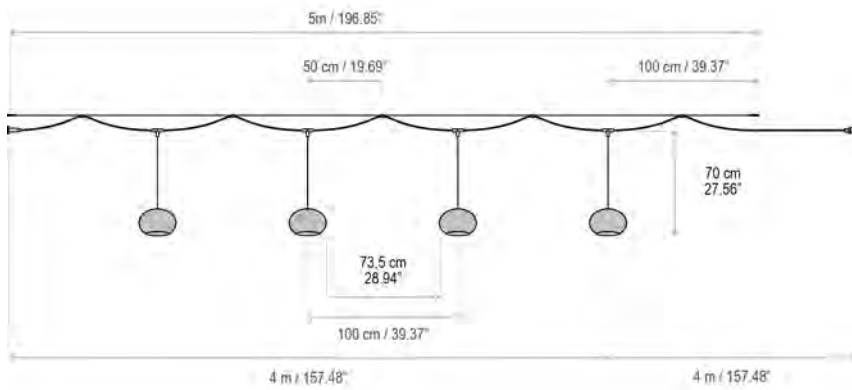

Garota Catenary S/27/4L IP-66

4 x 6 W LED / CRI: 90 / 2700°K  
4 x 450 lm fuente de luz / light source

Only for North America

Garota Catenary S/27/4L

4 x 6 W LED / CRI: 90 / 2700°K  
4 x 466 lm light source



Opciones LED consultar dibujo  
técnico en la ficha técnica

LED options consult technical  
drawing in the cutsheet

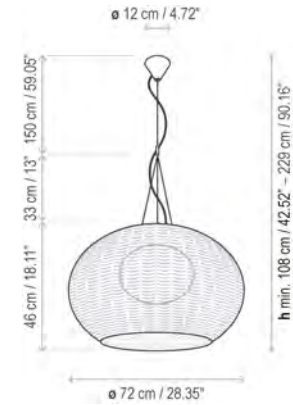
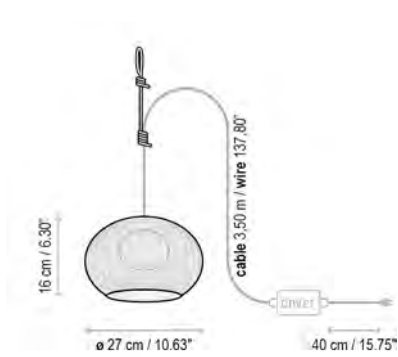

Garota Hang IP-66

⊙ 8,4 W LED / CRI: 90 / 2700°K  
1122 lm fuente de luz / light source

Garota S/01 IP-66

TRIAC ⊙ 8,4 W LED / CRI: 90 / 2700°K  
1122 lm fuente de luz / light source

Garota S/02 IP-66

💡 2 x MAX 15 W LED E-27 A60  
TRIAC ⊙ 17,1 W LED / CRI: 90 / 2700°K  
2064 lm fuente de luz / light source

Only for North America

Garota Hang WET

⊙ 8,4 W LED / CRI: 90 / 2700°K  
1122 lm light source

Garota S/01 WET

TRIAC ⊙ 8,4 W LED / CRI: 90 / 2700°K  
1122 lm light source

Garota S/02 WET

💡 2 x 10 W E26 LED A19  
0-10V TRIAC ⊙ 17,1 W LED / CRI: 90 / 2700°K  
2064 lm light source



Opciones LED consultar dibujo técnico en la ficha técnica

LED options consult technical drawing in the cutsheet

Opciones LED consultar dibujo técnico en la ficha técnica

LED options consult technical drawing in the cutsheet

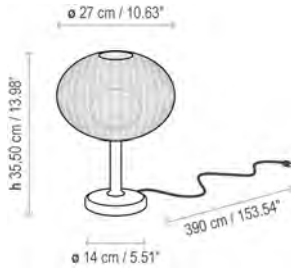

Garota M/36 IP-66

8,4 W LED / CRI: 90 / 2700°K  
1122 lm fuente de luz / light source

Garota P/01 IP-66

2 x MAX 15 W LED E-27 A60  
17,1 W LED / CRI: 90 / 2700°K  
2064 lm fuente de luz / light source  
17,1 W LED / CRI: 90 / 2700°K  
2064 lm fuente de luz / light source

Garota P/02 IP-66

2 x MAX 15 W LED E-27 A60  
17,1 W LED / CRI: 90 / 2700°K  
2064 lm fuente de luz / light source  
17,1 W LED / CRI: 90 / 2700°K  
2064 lm fuente de luz / light source

Only for North America

Garota Hang WET

8,4 W LED / CRI: 90 / 2700°K  
1122 lm light source

Garota S/01 WET

2 x 10 W E26 LED A19

Garota S/02 WET

2 x 10 W E26 LED A19

Acabados / Finishing



Blanco Roto  
Natural White



Marrón Grafito  
Graphite Brown

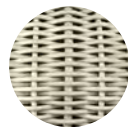

Blanco Marfil  
Ivory White



Marrón  
Brown



# Syra

by Alex Fernández Camps / Gonzalo Milà | 2014









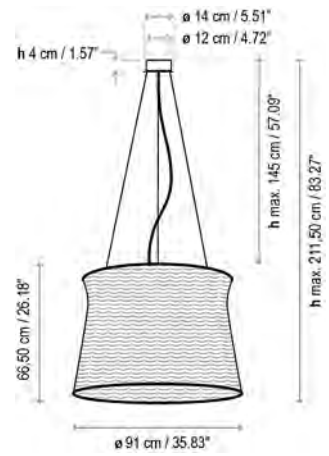
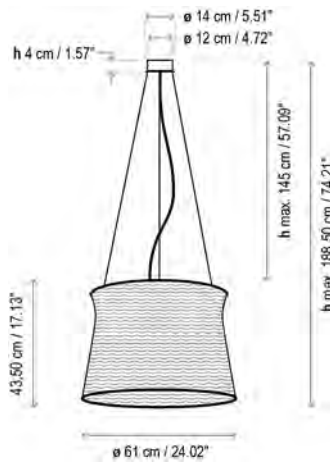
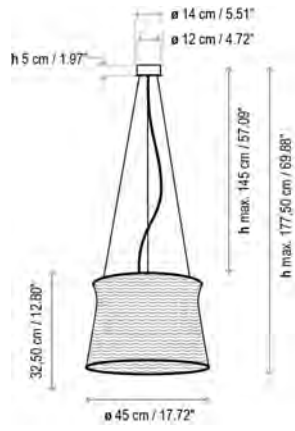

Syra 45 IP-66

24,7 W LED / CRI: 90 / 2700°K  
3400 lm fuente de luz / light source

Syra 60 IP-66

37,7 W LED / CRI: 90 / 2700°K  
4700 lm fuente de luz / light source

Syra 90 IP-66

39,7 W LED / CRI: 90 / 2700°K  
5500 lm fuente de luz / light source

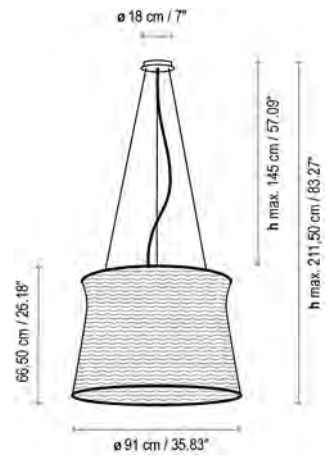
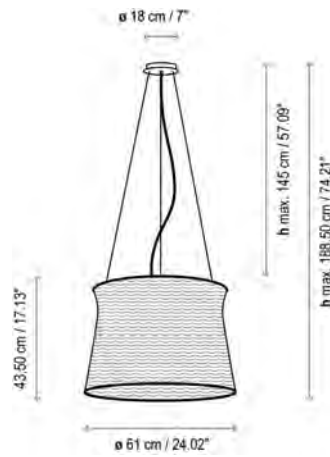

Only for North America

NOT AVAILABLE FOR NORTH AMERICA

Syra 60 WET

37,7 W LED / CRI: 90 / 2700°K  
4700 lm light source

Syra 90 WET

39,7 W LED / CRI: 90 / 2700°K  
5500 lm light source

Acabados / Finishing



Blanco Roto  
Natural White



Marrón Grafito  
Graphite Brown

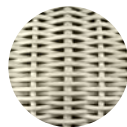

Blanco Marfil  
Ivory White



Marrón  
Brown









This product is not available for the North American market

Las Syra son productos ideales para espacios que necesiten luz cálida y elementos amables que ofrezcan buenas dosis de confort.

*Syra are ideal products for places that need warm light and friendly elements that offer plenty of comfort.*



This product is not available for the North American market



Syra 45 Outdoor









This product is not available for the North American market



# Cornet

by Alex Fernández Camps | 2017

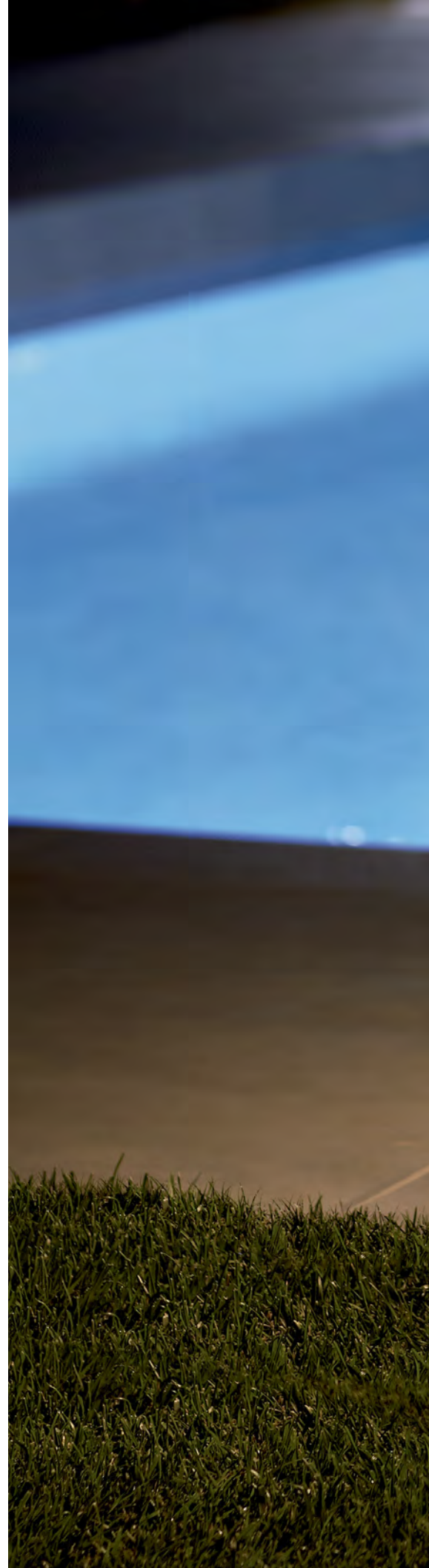





Cornet B/52











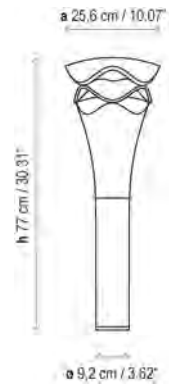
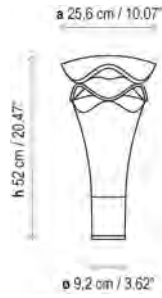

Cornet B/27 IP-66

TRIAC 8 W LED / CRI: 90 / 2700°K  
860 lm fuente de luz / light source

Cornet B/52 IP-66

TRIAC 8 W LED / CRI: 90 / 2700°K  
860 lm fuente de luz / light source

Cornet B/77 IP-66

TRIAC 8 W LED / CRI: 90 / 2700°K  
860 lm fuente de luz / light source

Only for North America

Cornet B/27 WET

TRIAC 8 W LED / CRI: 90 / 2700°K  
860 lm light source

Cornet B/52 WET

TRIAC 8 W LED / CRI: 90 / 2700°K  
860 lm light source

Cornet B/77 WET

TRIAC 8 W LED / CRI: 90 / 2700°K  
860 lm light source



Cornet B/27 Outdoor



Finishing / Acabados

---

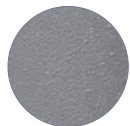

Gris Piedra  
Stone Grey



“Cornet es un proyecto con alto contenido técnico. Sus líneas armónicas y orgánicas consiguen mimetizarse con la naturaleza donde no existen líneas rectas.”

*“Cornet is a highly technical project. Its harmonious and organic shape allows it to blend in with nature where there are no straight lines.”*





Cornet B/27







# Moai

by Gonzalo Milà | 2017











Moai B/60



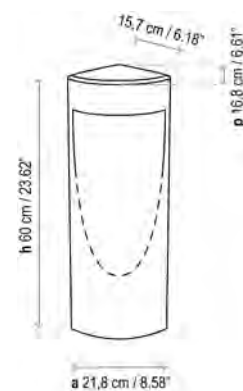
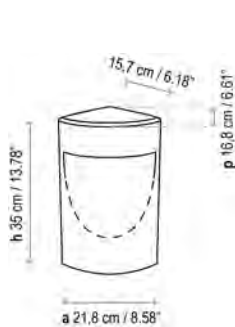

Moai B/35 IP66

TRIAC |  6,5 W LED / CRI: 90 / 2700°K  
850 lm fuente de luz / light source

Moai B/60 IP66

TRIAC |  6,5 W LED / CRI: 90 / 2700°K  
850 lm fuente de luz / light source

Only for North America

Moai B/35 WET

TRIAC |  6,5 W LED / CRI: 90 / 2700°K  
850 lm light source

Moai B/60 WET

TRIAC |  6,5 W LED / CRI: 90 / 2700°K  
850 lm light source

Moai es una lámpara de exterior donde hormigón, forma y luz trabajan juntas para dar protagonismo absoluto a esta sorprendente y novedosa unión.

*Moai is an outdoor lamp where concrete, shape and light work together to highlight this surprising and innovative combination.*

Finishing / Acabados

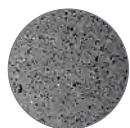

Cemento Gris  
Grey Concrete

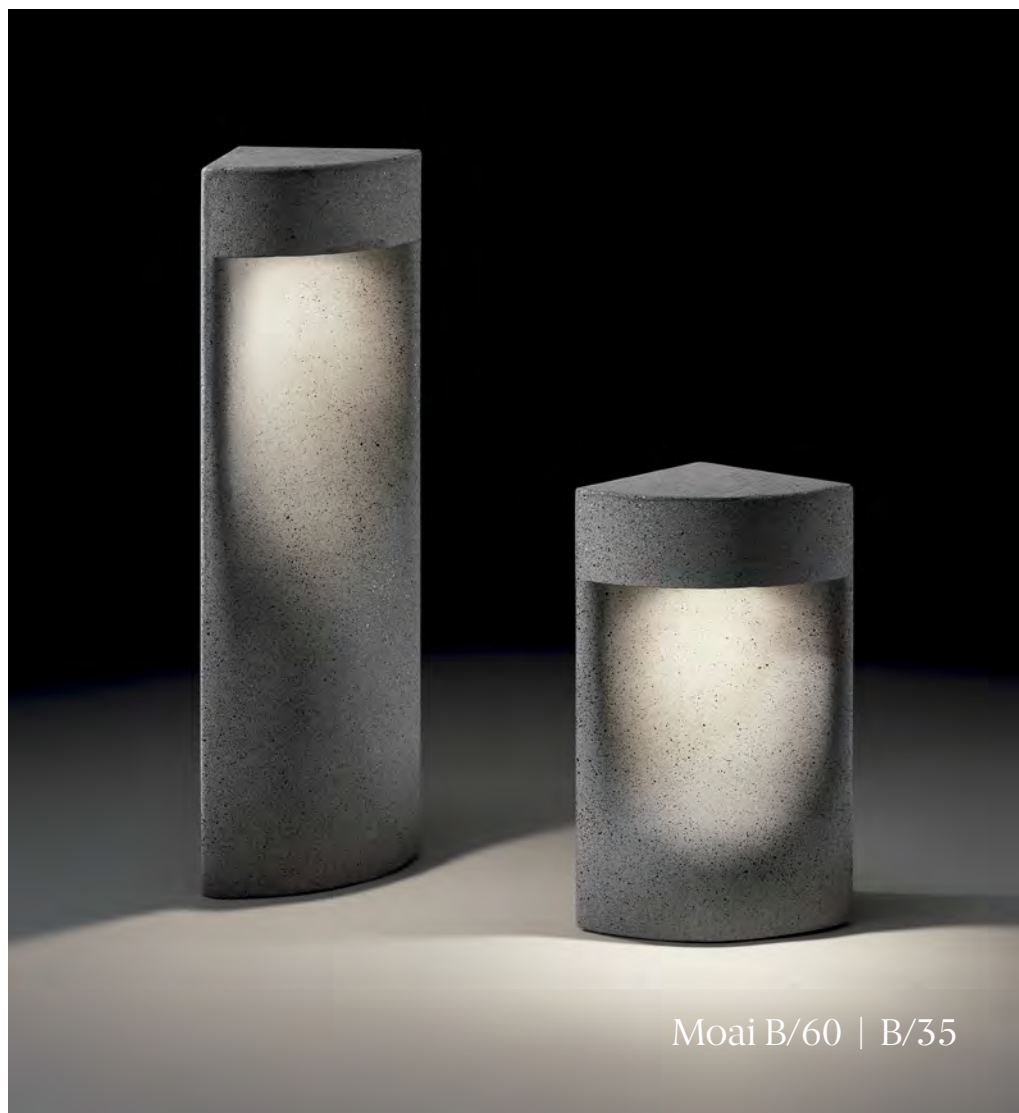

Moai B/60 | B/35



# Tria

by Rubén Saldaña | 2014











Las Tria son uno de los productos con mejor aceptación de nuestro catálogo, por este motivo decidimos llevarlas hasta nuestras terrazas y jardines.

Sus formas orgánicas, como piedras de río gastadas, hacen de ellas un objeto singular. A diferencia de las Tria indoor y debido a su grado de protección IP-66, las Tria outdoor no pueden instalarse de forma modular, son luminarias individuales.

*Tria is one of the most popular products of our catalogue, which is why we decided to take them outside to light our terraces and gardens.*

*Their organic shapes that remind us of polished river pebbles make them unique objects. Unlike the Tria Indoor and because of their IP-66 protection feature, the Tria Outdoor cannot be part of a modular system because they are single lighting units.*





Tria 04 Outdoor



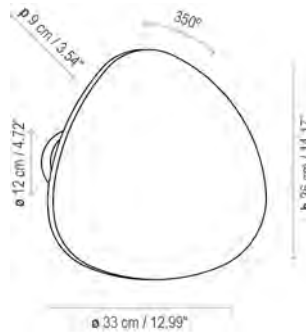
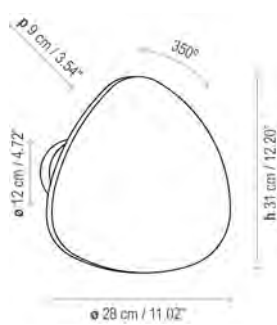
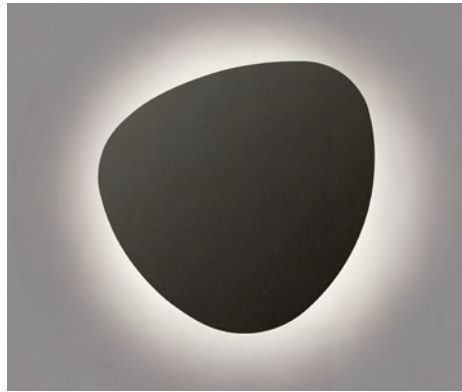
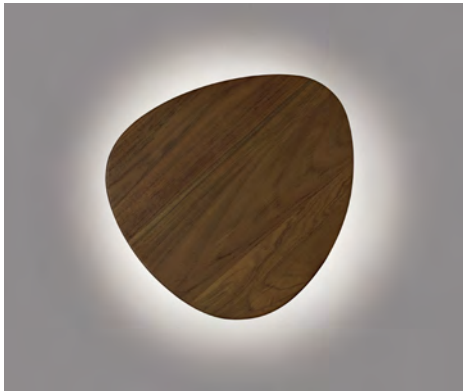

Tria 04 IP66

Tria 05 IP66

  11,5 W LED / CRI: 90 / 2700°K  
1346 lm fuente de luz / light source

  11,5 W LED / CRI: 90 / 2700°K  
1346 lm fuente de luz / light source

Only for North America

Tria 04 WET

Tria 05 WET

  11,5 W LED / CRI: 90 / 2700°K  
1346 lm light source

  11,5 W LED / CRI: 90 / 2700°K  
1346 lm light source

Acabados / Finishing



Frontal Metal Marrón Grafito  
Graphite Brown Metal Frontal



Frontal Madera Teca  
Teak Wood Frontal







Tria 04 Outdoor



# Marietta

by Joana Bover | 2015







Marietta S/32





Marietta S/32





La Marietta es un todoterreno, resistente, fácil de limpiar y muy polivalente. Un producto atemporal que puede convivir con productos contemporáneos, integrándose de manera natural en la vida de las personas.

Marietta goes anywhere – it is sturdy, easy to clean and very adaptable. A timeless product that can sit happily next to contemporary products, blending naturally with people's different lifestyles.



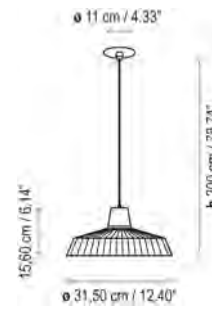

Marietta S/32 IP-66



 8 W LED / CRI: 90 / 2700°K  
 635 lm fuente de luz / light source

Only for North America

Marietta S/32 WET



 8 W LED / CRI: 90 / 2700°K  
 664 lm light source

Image does not show north American canopy

Acabados / Finishing



Blanco  
White





Marietta S/32



# Maxi

by Joana Bover | 2004







Maxi P/180



Opciones LED consultar dibujo  
técnico en la ficha técnica

LED options consult technical  
drawing in the cutsheet

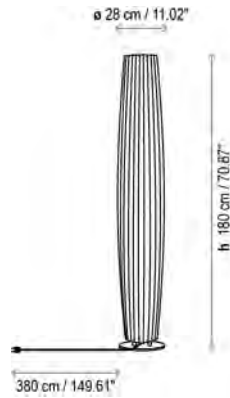

Maxi P/180 IP-66

2 x 28W T5 HE

49,2 W LED / CRI: 90 / 2700°K  
7500 lm fuente de luz / light source

TRIAC 49,2 W LED / CRI: 90 / 2700°K  
7500 lm fuente de luz / light source

Only for North America

Maxi P/180 WET

2 x 54W Minibipin T5 L. Fluo

49,2 W LED / CRI: 90 / 2700°K  
7500 lm fuente de luz / light source

0-10V 49,2 W LED / CRI: 90 / 2700°K  
7500 lm fuente de luz / light source

Opciones LED consultar dibujo  
técnico en la ficha técnica

LED options consult technical  
drawing in the cutsheet

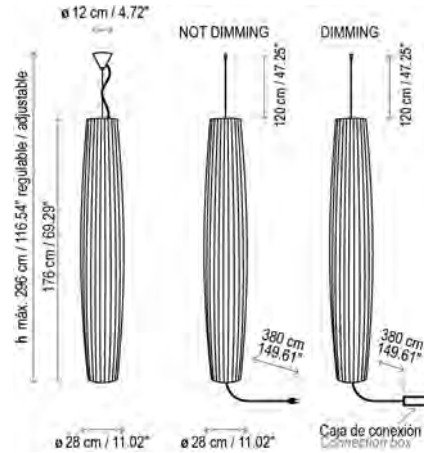

Maxi S/01 IP-66

2 x 28W T5 HE

49,2 W LED / CRI: 90 / 2700°K  
7500 lm fuente de luz / light source

TRIAC 49,2 W LED / CRI: 90 / 2700°K  
7500 lm fuente de luz / light source

Maxi S/01 WET

2 x 54W Minibipin T5 L. Fluo

49,2 W LED / CRI: 90 / 2700°K  
7500 lm fuente de luz / light source

0-10V 49,2 W LED / CRI: 90 / 2700°K  
7500 lm fuente de luz / light source

Acabados / Finishing



Blanco  
White





Maxi S/01



*Diseño Gráfico / Graphic Designer*

Miquel Llach

*Fotografías / Photographers*

Jordi Solé / J.E. Estudi Disseny

*Agradecimientos / Special Thanks*

Mireia Sust / Hoteles Vincci

Hoteles Meliá / Mallorca

Hostal Empúries / L'Escala

Maison Diez Company / México

Moss Floristas / Madrid

Hotel Arrey / Alella

Granja El Melindro / Cardedeu

Xavier Arimont / Hotel Mas Salvi (Pals/Girona)

*Depósito Legal / Legal Deposit: 18084-09*

Enero 2023

Avda. Catalunya 173  
Polígon Ind. Sud  
08440 Cardedeu  
Barcelona, Spain

T. +34 938 713 152  
F. +34 938 462 089  
info@bover.es  
www.bover.es

1231 Collier Road,  
Suite C  
Atlanta, GA 30318  
United States

T. +1 (404) 924 2342  
info@boverusa.com  
www.boverusa.com







